



**Sony Ericsson**

Mobile Phone **Z600**



# Sony Ericsson

GSM 900/1800/1900

This manual is published by Sony Ericsson AB, without any warranty.

Sony Ericsson Mobile Communications AB reserves the right to make changes or improvements to any of the products described in this guide without prior notice.

Such changes will, however, be incorporated into new editions of this manual.

All rights reserved.

© **Sony Ericsson Mobile Communications AB, 2003**

Publication number: 3-255-627-12(1)

## Please note:

Some of the services in this manual are not supported by all networks. This also applies to the GSM International Emergency Numbers (for example, 112).

Power consumption of charger during stand-by: below 0.3W

Halogenated flame retardant is not used in the cabinets.

Halogenated flame retardant is not used in the printed wiring boards in main portions.

Please read the guidelines for safe and efficient use (➡ **116 Safe and Efficient Use**) and the Limited warranty (➡ **120 Limited Warranty**) chapters before you use your mobile phone.

T9™ text input is a registered trademark of Tegic Communications Inc. and the T9™ text input software is provided under license of Tegic Communications Inc.

Bluetooth™ is a trademark owned by the Bluetooth SIG, Inc.

Java™ and all Java™-based marks and logos, including the coffee cup logo, are trademarks or registered trademarks of Sun Microsystems, Inc. in the United States and other countries.



## My Z600 information

*Phone information for your reference.*

For easy reference, please record the identification numbers of your mobile phone and SIM card. This information will assist you in customer inquiries to your retailer, manufacturer or network operator/service provider. In case of loss or theft of your phone and/or SIM card, call your network operator/service provider immediately to prevent misuse.

My mobile phone number:

---

Operator customer service number:

---

My SIM card number:  
(Printed on your SIM Card)

---

My phone's ID number (IMEI):  
(Printed on the label underneath the battery)

---

## About this manual

*Composition of this manual, Icon explanation.*

### Composition of this manual







This manual is composed of the following sections:

- Your Z600: your phone information.
- Getting started: start using your Z600.
- Basic operation: basic features of your Z600.
- Menu operation: how to use menu options.
- Appendix: additional information.

Note that the screen and icon in this manual may vary slightly in font and/or colour from the actual screen.

## Explanation of the icons

(Instruction purpose only.)

Icons	Explanations
	Important
	Notes
	Contact your network operator/ service provider for details
	Use the Soft/Navigation key to select
 <b>xx</b>	See also page xx
	Press the centre of the Navigation key
	Press the Navigation key down

# Contents

My Z600 information . . . . .	4	Getting started	
Phone information for your reference.		SIM card and Battery . . . . .	16
About this manual . . . . .	5	SIM card and Battery information.	
Composition of this manual, Icon explanation.		Using your Z600 . . . . .	19
Your Z600		Start using your phone.	
Included in your kit . . . . .	9	Basic operation	
What's in your kit.		Making Calls (Saving contacts) . . . . .	21
Covers and the Hand Strap . . . . .	10	Use Phonebook, Voice dialling, Speed dialling.	
Attaching covers and the Hand Strap.		Receiving calls . . . . .	25
Quick reference . . . . .	11	Receiving/Answering/Ending calls.	
An overview of the phone and its functions.		During a call . . . . .	27
Basic features . . . . .	12	Call options.	
Key functions, External display, Menu overview.		Voice control . . . . .	31
		Using voice commands.	

Text entry . . . . .	32	Connectivity . . . . .	73
Standard and T9 text entry.		WAP, Bluetooth, Synchronization, etc.	
<b>Menu operations</b>		Operator direct link . . . . .	91
Phonebook . . . . .	35	Accessing Operator defined direct links.	
Phonebook menu, Voice commands.		Internet services . . . . .	91
Messaging . . . . .	43	Accessing an online web page.	
Chat, SMS, MMS, E-Mail, etc.		Settings . . . . .	92
My shortcuts . . . . .	58	Personalising your phone settings.	
Creating your own Shortcuts menu.		Organizer . . . . .	99
Calls . . . . .	59	Calendar, Notes, Alarms, Timer, Stopwatch, Calculator and Code memo.	
Call options (configuring call conditions).		Entertainment . . . . .	106
Camera . . . . .	66	Playing games and downloading an application.	
Using the integrated camera.			
Pictures & sounds . . . . .	69		
Selecting, Composing, Recording sounds and pictures.			

## Appendix

Troubleshooting . . . . . 108

Security . . . . . 111

PIN, PIN2, SIM card and Phone locks.

Icon glossary . . . . . 113

Icons which may appear in the display.

Safe and Efficient Use . . . . . 116

Please read this information before using your  
mobile phone.



# Your Z600

## Included in your kit

*What's in your kit.*

The kit should include one mobile phone, one standard battery, two sets of exchangeable covers, one charger, one CD and this instruction manual. If one of these items is missing, please contact your retailer immediately.



Plug type differs from country to country.

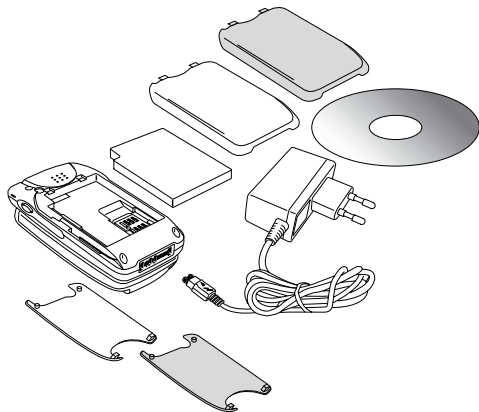

## Covers and the Hand Strap

*Attaching covers and the Hand Strap.*

### The exchangeable cover

Your Z600 comes with 2 different coloured covers. Place the cover onto the phone as illustrated below.

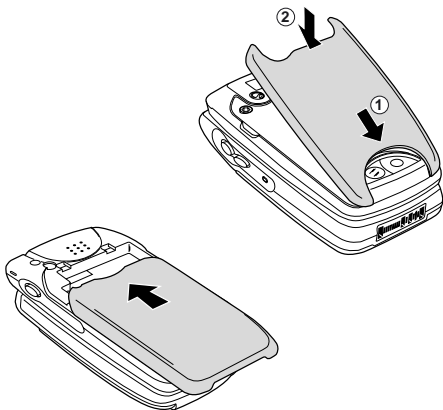

### The Hand Strap

Attach the hand strap to the phone as illustrated below.

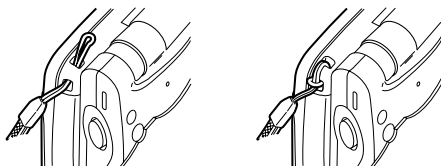

The hand strap is not included in your kit.

## Quick reference

*An overview of the phone and its functions.*

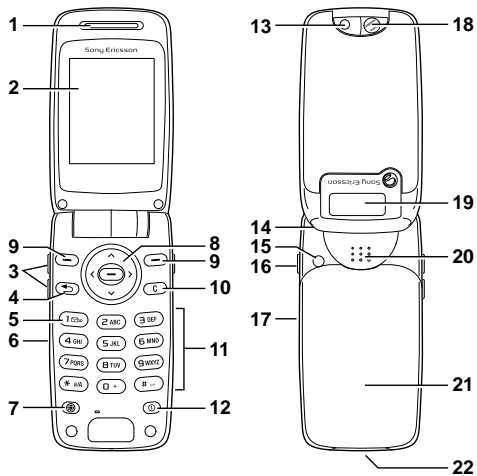







- |    |                            |    |                            |
|----|----------------------------|----|----------------------------|
| 1  | Earpiece                   | 12 | On/Off key                 |
| 2  | Display                    | 13 | Camera                     |
| 3  | Volume keys                | 14 | Strap hole                 |
| 4  | Return key                 | 15 | External antenna connector |
| 5  | Voice mail key             | 16 | Camera key                 |
| 6  | Charging/Network indicator | 17 | Infrared port              |
| 7  | Operator key               | 18 | Mirror                     |
| 8  | Navigation key             | 19 | External display           |
| 9  | Soft keys                  | 20 | Loudspeaker                |
| 10 | Clear key                  | 21 | Battery cover              |
| 11 | Keypad (Alphanumeric keys) | 22 | Connector                  |

## Basic features

*Key functions, External display, Menu overview.*

### Key functions

	On/Off	Switch on/off the phone.
	Soft	Select an option that appears above in the display.
	Return	Exit the menu.
	Operator	Access Operator direct link.
	Clear	Delete items from a list. Delete text/digit before the cursor. Press and hold to turn on/off mute (during calls) or sound.
	Voice mail	Press and hold to access your voice mail. ➔ <b>50 Call voice mail</b>



Camera





Activate Camera function.  
Take a picture.



Volume

Adjust the volume.







## Navigation Key

- |   |              |  |
|---|--------------|--|
|  | Press centre | Open Main menu from standby mode.<br>Select an option.                                   |
|  | Press right  | Open Main menu from standby mode.<br>Scroll through the menus, list and texts.           |
|  | Press left   | Access SMS (Write new) from standby mode.<br>Scroll through the menus, list and texts.   |
|  | Press up     | Access Internet services from standby mode.<br>Scroll through the menus, list and texts. |
|  | Press down   | Access Phonebook from standby mode.<br>Scroll through the menus, list and texts.         |

## External Display

Your Z600 has an external display for viewing information (for example, date, battery status, message indication) without opening the phone. This display is deactivated when the phone is opened.

### External display key functions

Key	Mode	Explanation
 	Standby	Activate backlight. 2nd press toggles between status items.
 	Event	Activate backlight. 2nd press dismisses screen or returns to standby mode.
 	Sleep	Activate backlight. Go to standby/event screen.

⊕ ⊖	Incoming call	Mute ringer. 2 x press in rapid succession rejects the call.
Press and hold	Standby Event Sleep	Activate backlight.
⊕ ⊖		

## Info/Help text

More information, explanation or tips about some menus or functions are available in your phone. Select the menu or function and press Info.

## More option

If you press **More**, a list of options is displayed. The option list differs depending on which menu you are in.

Pressing **More** in standby mode offers you the following options: Turn on silent, Turn on Bluetooth, Turn on infrared, Post note, Phone status.

## Menu overview

⊖ to access the Main menu from standby mode and move the Navigation key to scroll through the menu options.

Some menus are operator, network dependent.



(\* Only visible during calls.)

1 Operator direct link	2 Internet services	3 My shortcuts Write new Ring volume Select profile My numbers Edit shortcuts
4 Camera	5 Messaging Text Picture Call voice mail E-mail Chat WAP push Area info Options	6 Entertainment Games & more Other games
7 Pictures & sounds My pictures More pictures My sounds More sounds Themes More themes Picture editor Music DJ Record sound	8 Phonebook Call contact Find and send* Add contact Manage contact Pictures Personal rings Voice commands Special numbers Advanced Options	9 Calls Missed calls Call list Divert calls Manage calls Time and cost Next call Options
10 Connectivity Online services Bluetooth Infrared port WAP options Synchronization GSM Networks Data comm. Accessories	11 Organizer Calendar Notes Alarms Timer Stopwatch Calculator Code memo	12 Settings Sounds and alerts Display Profiles Language Time and date Voice control Locks Handsfree Master reset

# Getting started

## SIM card and Battery

*SIM card and Battery information.*

### SIM card

Your SIM (Subscriber Identity Module) card contains a computer chip with your service details and phone numbers. Like a credit card, it should be kept securely and handled carefully. Do not bend, scratch or expose to moisture. Avoid static electricity. To avoid corrupting the memory of your SIM card, always switch off your phone before removing or inserting your SIM card.



When you insert a new SIM card, your phone prompts you to select whether or not you wish to copy the SIM contents to the phone memory  
➡ **35 Phonebook.**

### *Inserting the SIM card*

- 1 Remove the battery cover and the battery.
- 2 Insert the SIM card into the holder.

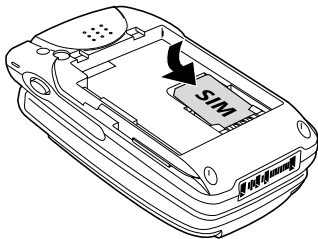

- 3 Replace the battery and the cover.

### *To remove the SIM card*

Follow steps 1-3 above removing the SIM card from the holder in step 2.



## Battery

Use only the Sony Ericsson-specified Z600 battery and charger. When supplied, your battery will not be fully charged.

■ Both the status bar within the battery icon in the display and the charging indicator (red) show the charging status.

Charging (5 °C-45 °C) is complete when ■ appears.

Full charging can take up to approximately 3 hours, but may vary depending on certain conditions (for example, if your phone is switched on or if temperature is outside the operating range).

When your battery is completely empty, it can take some time until the battery icon appears during charging.

As an energy-saving measure disconnect the charger from both the mains socket and the phone after charging.

On exposure to high temperatures your battery may expand slightly. This has no influence on your safety/health and will reduce to its original size once re-exposed to a lower temperature.

## Inserting the Battery

- 1 Slide the battery cover down to remove.
- 2 Align the claws on the battery terminal with those of the phone and press battery down.
- 3 Align the claws at the side of the cover with slots of the phone and slide back into place until the lock clicks.

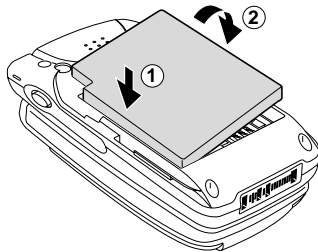

## Getting started

### *Removing the battery*

First power off and wait until the display goes blank. Remove the cover and then the battery.



If you insert a new battery, you must reset the clock.

### *Charging the battery*

- 1 Plug the charger into a mains socket.
- 2 Connect the charger to the bottom (jack) of the phone.

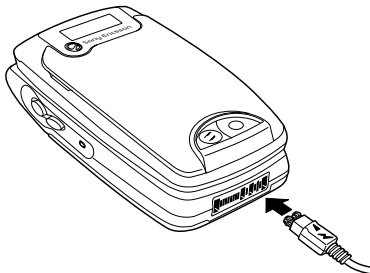

Removing the charger from the phone:

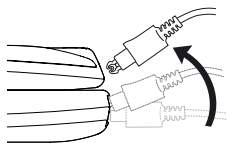

### Usage time

When your battery is nearly empty,  appears and a beep indicates that approximately 1 minute of talk time remains; however, if the Turn on silent option is activated there will be no tone.

## Using your Z600

*Start using your phone.*

### *Switching on your phone*

To switch on/off your phone, press and hold **(Ⓚ)**.  
(The first time you turn on the phone it takes up to 40 seconds to begin operating.)

### *Entering PIN*

Enter your PIN (Personal Identification Number) using the number keys (the PIN appears in code as \*\*\*\*) and press **Ok** or **(# -)** to confirm. ➔ **111 PIN (Personal Identification Number)**.



## Connecting to the network

After successfully entering your PIN, your phone searches for an available GSM network. The network search is automatic and may take a few seconds. (To select the network manually ➔ **87 GSM Networks.**)

You are ready to make and receive calls when the network operator's name and the signal strength icon appear in the display and the network indicator (green) blinks.

The following indicates the strength of the received network signal. If the signal is very weak, there is a risk of losing service.

  
Strong signal

  
Weak signal

  
Network not available

### If you cannot obtain service

If you cannot obtain a network service the reception strength may be too weak. Move to a higher elevation, a window or an open space and make sure that there is nothing obstructing the internal antenna area (front cover).

### Roaming

-  If you are out of range of your “Home” network operator, especially when abroad, another network operator may be selected automatically subject to signal strength and roaming agreements between network operators  
➡ **87 GSM Networks.**

# Basic operation

## Making Calls (Saving contacts)

Use *Phonebook*, *Voice dialling*, *Speed dialling*.

### Dialling a Number

- 1 Dial the complete number of the party you wish to call (including the area code even if dialling locally). In the case of international calls, press and hold **(+)** until + appears. Enter the country code followed by the area code and then the number.
- 2 Press **(C)** to correct any mistakes.
- 3 Press **Call** to dial the number displayed or

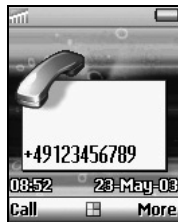

- 4 ▶ **More** ▶ **Save number** to save the number in the **Phonebook**.  
Select **New contact** to create a new contact entry or **Add to old** to save the number to an existing contact.



To hide/show your phone number when making a call ➔ **65 Next call**.

**Automatic re-dialling:** If connection fails, the message *Retry?* is displayed. Press **Yes** to activate the automatic re-dialling option (not available for fax or data calls). The phone automatically re-dials the number up to 10 times until the call is connected, you press a key or receive an incoming call. You will hear a tone when the call is connected.

### *Selecting a Phonebook entry*

- 1 In standby mode, press and hold an alphanumeric key to advance to the first letter on the key and then press the same key repeatedly to go to the letter you wish to find (for example, to advance to contacts beginning with “L”, press and hold **(5JKL)** to go to J and then press **(5JKL)** again 3 times to go to L).
- 2 Highlight the contact you wish to call and press **Select**.
- 3 Select the number and press **Call**.



You can also select a Phonebook entry from **Call contact** in **Phonebook** menu ➔ **36 Call contact**.



To call a contact from the SIM card, ➔ **42 Call from SIM**.

### **Making emergency calls**

Your phone supports the international emergency numbers, 112, 911 and 08. This means that these numbers can be used to make an emergency call in any country, with or without a SIM card inserted (network dependent), if a GSM network is within range. In some countries, other emergency numbers may also be promoted. Your operator may therefore have saved additional local emergency numbers on your SIM card.

To make an emergency call, enter an emergency call number (112, etc.) and press **Call**.

## Voice dialling

Voice dialling makes dialling Phonebook entries easy. Simply press and hold the volume key and say the person's name (Voice Tag) into the microphone. If you have several numbers for that person, say the number type, for example, "home". On recognition of the Voice Tag, the phone automatically dials after 3 seconds (the 3 seconds gives you time to cancel your call by pressing  or .

It is necessary to set up the Voice Tag and turn the Voice dialling option on in advance to use this option ➤ **23 Turn the Voice dialling on and record number types**, ➤ **23 Creating a Voice Tag entry**.



Press the handsfree button to start the Voice dialling when using a handsfree or Bluetooth headset. To activate Voice answer using accessories ➤ **26 Voice answering**.

### *Turn the Voice dialling on and record number types*

- ▶  Settings ▶ Voice control ▶ Voice dialling ▶ On
- Follow the instructions in the display and record number types.

### *Creating a Voice Tag entry*



- ▶  Settings ▶ Voice control ▶ Voice dialling ▶ Edit names ▶ New voice
- Select a contact.
- Follow the instructions in the display. An icon appears next to a contact name that has a voice command.

## Speed dialling

You can “speed dial” your chosen number by pressing the corresponding key and then Call. (For example, to call the number saved in position 1 on your SIM card, press  and Call.)

To use the Speed dialling option it is necessary to change the position of the numbers saved in SIM memory ➡ **24 Change SIM position numbers.**



You can assign up to 9 keys using  to .

### *Change SIM position numbers*

- 1 ▶  Phonebook ▶ Advanced ▶ Position list
- 2 Select the position number you wish to change.
- 3 Select the position to which you wish to move the number.
- 4 Press Select to confirm.

## Voice redialling

You can use your voice to redial the last dialled number. Simply press and hold the volume key and say “Re-dial” into the microphone. The voice command is played back to you and the last dialled number is called.

It is necessary to set up the redial command and turn the Voice redialling option on in advance to use this option ➡ **24 Turn on and record a redial command.**

### *Turn on and record a redial command*

- 1 ▶  Settings ▶ Voice control ▶ Voice redial  
▶ On
- 2 Instructions appear. Press Ok.
- 3 Lift the phone to your ear, wait for the tone and say “Redial”, or another word. If the recording sounds okay, press Yes. If not, press No and repeat step 2.



## Receiving calls

*Receiving/Answering/Ending calls.*

When you receive a call, the phone rings and the message **Answer?** is displayed.

If your subscription includes the Calling Line Identification service and the caller's number is identified, the number is displayed. If you have saved the number in the Phonebook, the name and number are displayed. If you have assigned a picture to the contact, the picture is displayed. If the number is a restricted number, the display will show **Withheld**.

## Answering/Ending calls

When the phone is open  
Press **Yes/No** to accept/reject a call.

When the phone is closed  
Open the phone and press **Yes/No** to accept/reject a call, or simply open the phone to accept the call when **Open to answer** option is set to **On**  
➡ **62 Open to answer**.



If you do not wish to answer the call, press **No**. The call will then be rejected (the caller will hear a busy tone (network dependent) or will be diverted if a divert has been set).

If a call is not answered,  appears in the top line of the display.

Press **Calls** for information about the missed call

➡ **59 Call list**.

In very rare cases, ciphering does not work in some networks, meaning that a third party can listen to your phone call. In this case,  appears in the display.

Press **End call** or close the phone to end a phone call.

### Headset

When the headset is connected to your phone, answer a call by pressing the headset button. Press headset button again to end the call.

### Bluetooth headset

When the Bluetooth headset is activated, press the headset button to accept/end a call.

### Voice answering

You can answer/reject an incoming call by using your voice, when using a portable handsfree (headset) or a car handsfree kit. When the phone rings, say “Answer/Busy” to answer/reject an incoming call. (When a call is rejected, the caller is diverted to your voice mail if activated or hears a busy tone.) It is necessary to set up the Voice answer command and turn the Voice answering option on in advance to use this option ➡ **26 To turn on voice answering and record voice answer command.**



*To turn on voice answering and record voice answer command*

- 1 ▶  Settings ▶ Voice control ▶ Voice answer ▶ On
- 2 Select the accessories you wish to be able to use with voice answering by pressing Check followed by Save.
- 3 Follow steps 2-3 in ➡ **24 Turn on and record a redial command** and say “Answer” in step 3.
- 4 Say “Busy”, or another word and press Ok.

## During a call

*Call options.*

### Adjusting the Ringer/Speaker volume

During a call, use the volume key to adjust the ringer/speaker/headset volume (press  = increase volume/press  = decrease volume). The microphone must be turned on to change the volume ➔ **27 Turn the microphone off/on.**

### Bluetooth headset

If the Bluetooth headset goes out of range during a call, the message, **Bluetooth connection lost. Retrieve call in phone?** is displayed and you are prompted to select **Yes/No** to transfer/end the call.

You can also transfer the sound to the phone or other headset devices during a call when you are using the Bluetooth headset.

### *To transfer sound*

- 1  ▶ Transfer sound or  
▶ More in standby mode.
- 2 ▶ To phone or select other handsfree device.







To transfer a call from Phone to Bluetooth headset, press the Bluetooth headset button, when Bluetooth headset is activated.

### *Turn the microphone off/on*

Press and hold  to mute/unmute the microphone.

### *Sending DTMF*

Press the alphanumeric key ( - ) followed by  and  to send the DTMF tone. Press  to clear the display after the call is finished.



### Notepad

Use your phone as a Notepad by entering a phone number during a call. When ending the call, the number entered will reappear in the display. Press **Call** to call the number or press **More** and **Save number** to save the number in the Phonebook.



The person you are talking hears tone signals while using the Notepad.  and select **Turn off tones** to turn the tone off.

### Ongoing call menu

During a call,  or press  for the following options (some options are network dependent):

- ▶ **Record** to record the conversation.
- ▶ **Turn off tones/Turn on tones** to turn off/on tones.
- ▶ **Hold call** to put the ongoing or conference call on hold.
- ▶ **Switch calls** to switch between 2 calls.
- ▶ **Release active** to end an active call.
- ▶ **Retrieve call** to retrieve a held call.
- ▶ **Join calls** to join calls into a conference call.
- ▶ **Transfer call** to connect the two calls.
- ▶ **Extract part** to have a private conversation with one of participants from the conference call and put others on hold. (Select **Join calls** to resume the conference call.)
- ▶ **Release all** to end multiple calls.

- ▶ Release part to release a participant from the conference call.
- ▶ Parties in conf. to view the identity of the parties in the conference call.
- ▶ Calls to make a new call.

## Call hold

-  Press Hold to hold the ongoing call or manage 2 calls at the same time.

### *One active call*

- 1 
- 2 ▶ Main menu ▶  Phonebook ▶ Call contact to retrieve a number from the Phonebook (or use the keypad to enter a number).
- 3 ▶ Call

-  You can only put one call on hold. Using the Notepad to make a second call, the call is put on hold automatically.

### *One active call (and/or one call on hold) and one call waiting*

- 1 Your phone alerts you (beep) that a call is waiting and the display automatically offers you call waiting options.
- 2 ▶ Answer to answer the second call and put the ongoing call on hold.  
or  
▶ Busy to indicate to the calling party that your line is engaged.  
or  
▶ Release & answer to answer the second call and end ongoing call.



To turn the call waiting option on/off ➔ **61 Call Waiting.**

When the headset is connected to your phone, answer a waiting call by pressing the headset button. In the case of one active call and one call on hold, alternate between 2 calls by pressing the headset button.

### Handling two calls

When you have one ongoing call and one call on hold, you can do the following:

▶ **Switch** to switch between the two calls.

 and select **Transfer call** to connect the two calls. You are disconnected from both calls.

▶ **End call** to end the ongoing call, then press **Yes** to retrieve the held call or **No** to end both calls.



You cannot answer a third call without ending one of the first two calls.



## Conference call



It is possible to have a conference call consisting of 5 calls and a single held or waiting call (network dependent). There may be additional charges for calls involving multiple parties.

You must first have one ongoing call and one call on hold to create a conference call.

### *Creating a conference call*

- 1  ▶ **Join calls**
- 2 ▶ **Hold** to put the conference call on hold.
- 3 **Call** the next person you wish to include in the conference call.
- 4  ▶ **Join calls**
- 5 **Repeat** steps 2-4 to include more participants.  
Select **Release part** in step 4 to release a participant or press **End call** to end the conference call.

## Voice control

*Using voice commands.*

With your phone, you can use your voice to:

- Voice dial ➡ **23 Voice dialling.**
- Re-dial the last dialled number ➡ **24 Voice redialling.**
- Answer and reject calls ➡ **26 Voice answering.**
- Record or listen to sound recordings by using voice commands ➡ **32 Sound recordings.**
- Activate the voice control by saying a “magic word” ➡ **31 The magic word.**

You can save approximately 50 recorded words as voice commands in the 40 seconds available. This also depends on what is saved in the memory (other functions). To edit your voice commands ➡ **96 Editing your voice commands.**

## The magic word

You can record a magic word and use it as a voice command to allow total handsfree access to voice control. Instead of pressing a volume key, you say the magic word and then one of your recorded voice command. It is recommended to select a long, unusual word which can easily be distinguished from ordinary background speech.

*Turn on and record the magic word*

- 1 ▶  Settings ▶ Voice control ▶ Magic word  
▶ On
- 2 Select a profile and press **Save**.
- 3 Instruction appears. Press **Ok**.
- 4 Lift the phone to your ear, wait for the tone and say the profile name. Repeat steps 3 and 4 to record voice commands for the other profiles.





Turn off the magic word when you no longer need total handsfree access in order to save battery power.

## Sound recordings

Record or listen to sound recordings by using voice commands.

*Turn on and record recording command*

- 1   Settings ► Voice control ► Sound recorder ► On
- 2 Instruction appears. Press Ok.
- 3 Lift the phone to your ear, wait for the tone, say “Record” and press Yes.
- 4 Say “Play” and press Yes.



You can listen to the recording by pressing and holding a volume key from standby mode and say “play” after the tone. Press Cancel to stop listening.





## Text entry

*Standard and T9 text entry.*

## Input languages

Before you start entering letters, you need to select the input languages that you wish to use when writing.

*Selecting input languages*

- 1   Settings ► Language ► Input
- 2  to scroll to the language that you wish to use for entering letters and  or press Check to select each language you wish.
- 3 Press Save to exit the menu.





When writing, you can switch to one of your selected input languages by pressing More and then selecting Input language.



## Standard text entry

Press the corresponding alphanumeric key multiple times until the desired character appears (multi-tap mode).

*Sample entry with standard text entry (entering s)*

- 1 ►  Messaging ► Text ► Write new
- 2 Press  multiple times until s is displayed.
- 3 Wait to confirm.





Press  to shift between:

Aa upper case letter and then revert back to lower case

A upper case letters permanently

a lower case letters permanently









Press and hold  or press More and select Input method followed by T9 input to activate/deactivate the T9 function ► **33 T9 text entry.**

Press  to clear the character or number before the cursor.



## T9 text entry

T9 text entry method uses a built-in dictionary that recognises the most commonly used word for each sequence of key presses. You need to press each key only once, even if the letter you wish is not the first letter on the key.

*Sample entry with T9 text entry (entering Sony)*

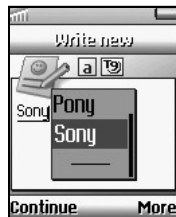
- 1 ►  Messaging ► Text ► Write new
- 2 ► More ► Input method ► T9 input, or press and hold  if  does not appear.
- 3 Press  to shift to Aa.
- 4 To type the word Sony, press each of the following keys in order: , , , .





- 5 At the end of the word, check the preview screen for the possibilities found for the key combination you typed.
- 6  to highlight **Sony**. If your desired word is first on the list, just press **Select** to select it or press  to enter a space and proceed with the next word



If the word you intended to type does not appear in the list, press **More** followed by **Spell word** and type the word using standard text entry method ➡ **32 Text entry**. When finished, press **Insert**. This new word will automatically be added to the T9 memory and will appear in T9 mode in the future.  
T9 function is not supported by some languages.

While using text entry, press **More** to open the options of **Add symbol**, **Insert item**, **Spell word (T9 only)**, **Text format**, **Input language**, **Input method**, **Word suggestions (T9 only)**, **My words (T9 only)** and **Help**.

### *Adding a symbol*



To insert a symbol when creating a message, press  or  multi times until the desired symbol appears or press **More** and select **Add symbol** to add a symbol from the list.



For “Smart Punctuation”, just press  where you would add a full stop, hyphen or apostrophe. T9 will automatically insert the most likely punctuation.

# Menu operations

*Selecting a menu item with the Navigation key/Soft key*

- 1  to access the Main menu from standby mode and move the Navigation key to scroll through the menu options.
- 2  or press **Select** to select a menu option.
- 3  to exit a menu.



Your phone automatically defaults to standby mode after a few minutes of inactivity.



## Phonebook

*Phonebook menu, Voice commands.*

You can store the information on your SIM card and on your phone. You have space for up to 510 entries (up to 20 characters for each name and up to 40 digits for each number). Entries saved as contacts are saved only in your phone memory. To synchronise your phone-based contact list with your PDA or PC ➔ **86 Synchronization.**

### Saving Phonebook Entries

- ➔ **21 Making Calls (Saving contacts),**
- ➔ **36 Add contact.**

### Making Calls

- ➔ **21 Making Calls (Saving contacts),**
- ➔ **22 Selecting a Phonebook entry or**
- ➔ **36 Call contact.**

## Call contact

▶  Phonebook ▶ Call contact

Select this option and enter a letter using the keypad to retrieve an entry from your Phonebook.

## Default number

Each contact has a default phone number. The first phone number you link to a contact automatically becomes the default number. If you select a certain contact in the Call contact list, the default number is highlighted.

### *Set the default number*

- 1 ▶  Phonebook ▶ Manage contact  
▶ Edit contact and retrieve an entry from your Phonebook.
- 2 Highlight the name and press **Edit** or **More**.
- 3 ▶ Default number
- 4 Highlight the number you wish as default and press **Select**.

## Find and send

▶  Phonebook ▶ Find and send

You can find and send a number (DTMF) during a call. (This option is only available during a call.)

To access Find and send option,  and select **Main menu** followed by **Phonebook**, and then select **Find and send**.

## Add contact

▶  Phonebook ▶ Add contact

You can add contacts to your Phonebook.

### *Adding contacts*

- 1 ▶  Phonebook ▶ Add contact
- 2 Scroll to the field you wish to fill in and press **Add**.
- 3 Enter the number/information or press **Look up** to retrieve a number from **Phonebook/SIM entries/Unsaved numbers**.
- 4 When you have entered the number/information, press **Save**.

## Manage contact

▶  Phonebook ▶ Manage contact

Manage contact contains the following options:

### View contact

Display all information that is saved in each entry. Retrieve an entry from your Phonebook and press **View**.

### Edit contact

Edit existing contacts.

#### *Editing contact*

- 1 ▶  Phonebook ▶ Manage contact  
▶ Edit contact and retrieve an entry from your Phonebook.
- 2 Select an entry and press **Edit**.
- 3 ▶ Edit info (you can also edit the following items: picture, ring signal, voice, positions, default number.)
- 4 Select the field you wish to edit and press **Edit**.
- 5 Enter the information and press **Ok**.

- 6 Press **Save**.

## Send contact

You can send a contact to another device.

### *Sending contact*

- 1 ▶  Phonebook ▶ Manage contact  
▶ Send contact and retrieve an entry from your Phonebook.
- 2 Select the contact you wish to send.
- 3 ▶ Send and select from the following options: As picture msg, As text msg, Via Bluetooth or Via infrared.

## Delete contact

Follow steps 1-2 in  **37 Editing contact** and select **Delete** in step 2.



You can also delete an entry by pressing **C** when highlighted.

### My card

You can add your own business card to the Phonebook. Select **Add** to create your business card.

You can also exchange business cards between your phone and another similar phone, a PDA or a PC via Bluetooth, the infrared port, text or picture message.

#### *Sending your business cards*

- 1 ▶  Phonebook ▶ Manage contact ▶ My card
- 2 ▶ Send and select from the following options: As picture msg, As text msg, Via Bluetooth or Via infrared.



When you receive a business card via a text message, you accept the card by pressing **Yes**. To be able to receive a business card via the infrared port or Bluetooth, make sure to turn these functions on.

### Groups

You can create a group of contacts. Using the group, you can send a text message to the several recipients at a time (▶ **43 Multi-Party message**).

#### *Assigning groups*

- 1 ▶  Phonebook ▶ Manage contact ▶ Groups ▶ New group
- 2 Enter a name for the group and press **Ok**.
- 3 ▶ **New member** and retrieve the contact and number from your Phonebook.
- 4 Repeat step 3 to add more members or press **Done** to save.

## Pictures

▶  Phonebook ▶ Pictures

You can add a picture to a Phonebook contact.

### *Adding a picture to a contact*

- ▶  Phonebook ▶ Pictures
- Retrieve an entry from your Phonebook and press **Select**.  
The phone will automatically take you to My pictures.
- Select a picture and press **Select** followed by **Yes**.

## Personal rings

▶  Phonebook ▶ Personal rings

Assign a personal ring to a contact.

### *To set a ring signal for a caller*

- ▶  Phonebook ▶ Personal rings  
▶ New contact
- Retrieve an entry from your Phonebook and press **Select**.

- Select a ring signal.

## Voice commands

▶  Phonebook ▶ Voice commands

Assign a voice command to a contact.

➡ **95 Voice dialling.**

## Special numbers

▶  Phonebook ▶ Special numbers

-  This section may contain special numbers such as Fixed numbers, My numbers, SOS number, Info numbers and Service numbers (SIM card dependent). You can **Call**, **Edit** and **Delete** the Fixed Numbers list. You need the PIN2 to edit, delete and copy.

## Fixed numbers

This section may contain Fixed numbers (SIM card dependent). The fixed dialling function allows calls to be made only to certain numbers (except emergency calls, 112 etc.) saved on the SIM card. Before you use the Fixed numbers,

you will need to turn this option on. You need the PIN 2 to edit and delete.



Partial numbers can be saved. For example, saving 0123456 allows calls to be made to all numbers starting with 0123456.

Numbers with question marks can be saved. For example, saving 01234567?0, allows calls to be made to numbers from 0123456700 to 0123456790. Press and hold  to enter ?.

### *Creating Fixed numbers entries*

- 1 ▶  Phonebook ▶ Special numbers  
▶ Fixed numbers ▶ New number
- 2 Enter the PIN2 and press Ok.
- 3 Enter the phone number and press Ok to confirm.
- 4 Enter a new name and press Ok to confirm.
- 5 Enter a position and press Ok to confirm.

### *Editing Fixed numbers*

- 1 ▶  Phonebook ▶ Special numbers  
▶ Fixed numbers
- 2 Highlight the name you wish to edit and press Select to confirm.
- 3 ▶ Edit
- 4 Enter the PIN2 and press Ok.
- 5 Edit the Number, Name and Position and press Ok to confirm.

### *My numbers*

You can check your own phone number(s). Depending on your SIM card, you can save multiple My Number entries.

### *Info numbers*

This section of the Phonebook may contain Info numbers, for example, taxi number (network/SIM dependent).



## Service numbers

This section of the Phonebook may contain Service Dialling Numbers (SIM card dependent). Service numbers cannot be edited.

## SOS numbers

View your local emergency numbers.

To make an emergency call ► **22 Making emergency calls.**

## Advanced options

►  Phonebook ► Advanced

## Memory status

Display how much memory is available for the Phone, SIM, E-mail and Voice commands areas.

## Copy from SIM

Copy contacts saved in the SIM memory to the Phone memory.



When you have selected a contact from the SIM card in the Call from SIM option, you can copy it to the phone by pressing More and then selecting Copy to phone.

## Position list

Change the position of Phonebook entries saved in your SIM card. To change the position ► **24 Change SIM position numbers.**

## Copy all to SIM

Copy all contacts saved in the Phone memory to the SIM card. Please note that everything on the SIM card is replaced.



If the memory is full, you will receive the message, Memory full. and copy option will be cancelled.

### Call from SIM

If you insert a SIM card with saved contacts into your phone, you can call a contact by selecting this option. If you wish to edit a contact saved on the SIM card, you first need to copy the contact to the phone.

### Send all

Send all contacts via Bluetooth or the infrared.

### Delete all

Delete all contacts saved in the Phone memory.

## Options

►  Phonebook ► Options

### Contact info.

Set the contact fields in contact information.

Select **Check/Uncheck** to select/clear fields.

If your Phonebook is empty, you are prompted to copy information from your SIM card. Press **Yes** to copy information from your SIM card to Phone or **No** to add new contacts.

### Ask to save

Turn this option off to save a new phone number to the Phonebook at the prompt.

### Synchronize view

Set the order of the names (starting first or last name) during synchronization of contacts.

### Fixed dialling

Select this option and enter PIN2 to activate/deactivate the Fixed dialling option.

## Messaging

*Chat, SMS, MMS, E-Mail, etc.*

This feature offers correspondence options to read, write and send messages (text, chat and picture message) and/or E-mail ➔ **50 E-mail**. Before you use Messaging option you will need to set your service centre number ➔ **46 Service centres**.

### Multi-Party message

It is possible to send one message to maximum 10 recipients at a time. To create a multi-party SMS, follow steps 1-4 in ➔ **45 Send text message** and select a group from the Phonebook in step 4 (➔ **38 Groups**).

### Long message

It is possible to send a longer message by linking two or more messages (160 characters each) to one recipient at a time. Long message can only be displayed/read once all parts are received (by recipient) ➔ **47 Long message**.



Once you have created a message, the phone will automatically split the message into pieces and send to recipients.

Please check with your service provider for the maximum number of messages that can be combined to one long message.

### Receive message

When a new message arrives, you will hear a beep (editable ➔ **58 Message alert**) and see the message *Read now?* appears while in standby mode. Press *Yes* to display the message.

#### *To read message*

- 1 ▶  Messaging ▶ Text or ▶ Picture and select one of the following options:
  - ▶ **Inbox** to read received messages or
  - ▶ **SIM archive** to read messages saved on SIM card or
  - ▶ **Unsent items** to read unsent messages or

- ▶ Sent items or Last sent to read sent messages.
- 2 Scroll through the list of messages to select the message you wish to read and press Read.
- 3 Press More offers you the following options: Reply and delete, Chat, Call, Delete, Forward, Save in archive and Print via Bluetooth.



The capacity for storing incoming and outgoing messages depends on your SIM card and the phone memory.

The message memory is full when  is displayed. Delete old messages in order to free memory space for new messages.

While reading the message you can, for example, start a chat session with the sender or go to a WAP address displayed.

Select Delete all in step 3 ➡ **43 Receive message** to clear all messages.

You can receive a maximum of 20 messages. You may have to delete old messages before you can receive new ones.

*To call back the sender of a message or a number in the message text*

Follow steps 1-3 in ➡ **43 To read message** and select Call in step 3 to call back the sender or highlight the number you wish to call back from the number(s) appearing in the message, then press Call.

*To save a message on the SIM*

Follow steps 1-3 in ➡ **43 To read message** and select Save in archive in step 3.

When the phone number/WAP address/ picture/ animation/melody is highlighted, press More and select Save to save it in Phonebook/Bookmarks/ My pictures/My sounds.

## Send text message

Create and send text messages (SMS).

### *To Create and send text message*

- 1 ▶  Messaging ▶ Text ▶ Write new
- 2 Create your message.
- 3 ▶ Continue
- 4 ▶ On to request reply or  
▶ Off not to request reply (if the Request reply option is set to Set on send).
- 5 Enter the number or select the number/group from the Phonebook by selecting Look up.
- 6 Press Send.



If you are interrupted (for example, incoming call) while creating a message, select **Unsent items** to retrieve the message and complete it continuing from step 3 ➔ **45 Send text message**.

Selecting **Recipients** offers the option to add another name/number to the group list.

Select **View status** from **More** menu to check the status of sent messages ➔ **47 Status request**.

As a shortcut,  in standby mode to start writing a text message.

### Text message templates

you can create and save messages that you send often as templates. There are 5 pre-defined templates in your phone (editable).

#### *To create a template*

- 1 ▶  Messaging ▶ Text ▶ Templates  
▶ New template
- 2 Write a message and ▶ Ok.
- 3 The message, Use template to create message now?, appears  
▶ Yes to send the message now or  
▶ No to save the template.

### Text message options



Message options allows you to customise outgoing messages including the format, confirmation report etc.

When **Set on send** is activated, you need to select the settings each time you send a message.

Some of these options may be network operator dependent.

#### Service centres

Register your service centre number before you send short messages.

#### E-mail gateways

Enter an E-mail gateway phone number to send a text message to an E-mail address via your network operator.

#### SMS type

Specify how your message is transmitted: Text, E-mail, Fax, Voice (if available), Pager, ERMES, Set on send. The default setting is Text.

### Validity period

Specify how long messages are stored in the service centre by selecting: 1 hour, 12 hours, 1 day, 1 week, Maximum, Set on send. The default validity period is Maximum (network dependent).

### Request reply

Include a reply request if you wish the recipient to reply.

### Status request

Select On or Set on send if you would like to receive confirmation that your message has been successfully transmitted.

### Long message

Select On if you would like to send a long message.

### SMS memory

Display how much memory is available for Phone and SIM areas.

## Picture Message (MMS)

►  Messaging ► Picture

Picture message can contain text, pictures and sound, and are sent via MMS (Multimedia Messaging Service). You can also send contacts (Phonebook entries), calendar entries, sound recordings and notes as attachments.



To avail of MMS service you must first set your Server Centre number and create a WAP profile  
 ➤ **49 Message server** and ➤ **79 WAP options**.

*To compose and send picture message*

- 1 ►  Messaging ► Picture ► Create new
- 2 Select from the following options:
  - Picture to access My pictures.
  - Text to write a message.
  - Sound to access My sounds.
  - Camera picture to compose from/access Camera.
  - Recording to record a sound.

- ▶ Page to start a new page.
- 3 ▶ Add to continue composing the message.
- 4 ▶ More for the following options:
  - ▶ Send to send the message.
  - ▶ Preview to view the message.
  - ▶ Preview page to view the page in the message.
  - ▶ Page timing to set the duration in seconds that the page will be displayed on the recipient's display.
  - ▶ Background to set the background colour.
  - ▶ Delete page to remove the page.
- 5 ▶ More ▶ Send and enter the number or select number/group/E-mail address from Phonebook entries by selecting Look up.
- 6 ▶ Send



If you entered the phone number manually, press Proceed to go to ➤ **48 Advanced send options.**

### Advanced send options

By pressing **More** before sending a picture message, you can enter more information to accompany the message as follows:

- |            |   |
|------------|---|
| ▶ To:      | Phone number or E-mail address. These can be selected from the Phonebook. |
| <hr/>      |   |
| ▶ Subject: | Write a title (▶ Ok to confirm).  |
| <hr/>      |   |
| ▶ Cc:      | Phone number or E-mail address.   |
| <hr/>      |   |
| ▶ Bcc:     | Phone number or E-mail address.   |



► Attachments: Add your own card, a business card or melody from *My sounds*.

---

► Priority: High, Normal or Low.

---

► Delivery report: Turn on/off.

---

► Read report: Turn on/off.

## Picture message template

There are 5 pre-defined templates in your phone (editable). To make changes to templates, select a template and press *Add*.

## Picture message options

Customise outgoing messages including the format, confirmation report etc.

## Validity period

Specify how long messages are stored in the service centre by selecting: 1 hour, 12 hours, 1 day, 1 week, Maximum. The default validity period is Maximum (network dependent).

## Read report

Select *On* if you would like to receive confirmation that your messages has been read by the recipient.

## Delivery report

Select *On* if you would like to receive confirmation that your messages has been successfully transmitted.

## Restrict messages

Limit messages sent/received, for example, if you do not wish to receive any advertisements.

## Content alert

Select *On* if you wish to be alerted about the problems when sending messages, for example, the message is too large or recipient might not be able to view the message.

## Message server

View or enter your message server information.

## WAP profile

Specify which WAP profile is used or create a new WAP profile by selecting *Create new*.



### Memory status

Display how much memory is used for MMS function.

### Call voice mail

►  Messaging ► Call voice mail

- ④ Select this option to call your voice mail. You can also press and hold  for quick access to your voice mail.

To set up the voice mail number ► **58 Voice mail number**.  or  appears in the display (network dependent) to inform you when you have received new voice messages. Press Yes to listen to/read the message.

### E-mail

►  Messaging ► E-mail

- ④ You can send and read E-mail by accessing to your office E-mail server or your Internet service provider on the Internet (POP3 and IMAP4 are supported). You will need the specific parameters from your Internet service provider in order to complete the setup (some service providers or network operators do not offer this service). It may also be possible for you to obtain these parameters in a text message or from the web page of your network operator/service provider (at [www.SonyEricsson.com](http://www.SonyEricsson.com) you can receive settings in a text message). Be sure to make your settings before you start using E-mail ► **54 E-mail Options**.

## Send and receive E-mail

This option offers the fastest way to send E-mail saved in **Outbox** and check for new E-mail.





You will still be able to access the mail from your PC after you have read it using your phone. You can only delete mails from your PC.

The phone can save up to six complete E-mail depending on size (you can download headers only **▶ 54 Set account**).

You can receive an E-mail with attachments. The attachments can be found at the end of the message.

You can save the sender's address by pressing the **Save** after selecting the sender.

## Reading E-mail

- 1 ▶  Messaging ▶ E-mail ▶ Send and receive to download E-mails to the phone.
- 2 ▶  Messaging ▶ E-mail ▶ Inbox
- 3  to highlight the E-mail that you wish to read and press **Select** to read it. Pressing **More** when reading, you have the following options: **Reply all**, **Mark for deletion**, **Mark as unread** and **Copy to archive**.



When the E-mail address or phone number is highlighted, select **Save** to save it.

### *To Create and send E-mail*

- 1 ▶  Messaging ▶ E-mail ▶ Write new
- 2 Select one of entries for the following options and press **Edit**:

▶ **To:** to enter name and E-mail address (to retrieve an E-mail address from Phonebook entries or received E-mails in your inbox, press **Add** followed by **Look up** and select Phonebook or Archive).

- ▶ **Cc:** to send a copy of the E-mail to another recipient.
- ▶ **Priority:** to set the E-mail priority.
- ▶ **Subject:** to write a title.
- ▶ **Text:** to write your message.
- ▶ **Attachments:** to add pictures.

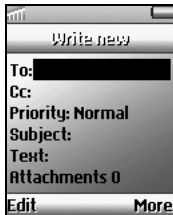

- 3 ▶ **More** and select one of entries for the following options:
  - ▶ **Send now** to send the E-mail
  - ▶ **Send with attach.** to attach a picture from **My pictures** (▶ **69 My pictures**) or from a digital camera connected via IR (▶ **66 Camera**) before sending. Select **Send** to send the E-mail.
  - ▶ **Save to outbox** to save the E-mail in the Outbox.
  - ▶ **Save to draft** to save the E-mail in the Drafts folder.
- 4 **Send and receive** to send all E-mails saved in the Outbox (▶ **51 Send and receive E-mail**).

*To delete an E-mail (POP3 users)*

- 1 ▶  Messaging ▶ E-mail ▶ Inbox
- 2 Select an E-mail and press More.
- 3 ▶ Mark for deletion.
- 4 The message is deleted the next time you connect to your E-mail server by selecting Send and receive.

*To delete an E-mail (IMAP 4 users)*

- 1 ▶  Messaging ▶ E-mail ▶ Inbox
- 2 Select an E-mail and press More.
- 3 ▶ Mark for deletion. The message is marked for deletion on the server.
- 4 ▶ Empty inbox
- 5 The message is deleted the next time you connect to your E-mail server by selecting Send and receive.

## Archiving

You can archive an E-mail in order to read it later. You can archive only as much text as the display shows.

*To archive an E-mail*

- 1 Open the E-mail.
- 2 Make sure that the text you wish to archive is visible in the display.
- 3 Place the cursor in the text and press More.
- 4 ▶ Copy to archive  
The text can be found in Archive in the menu.

### E-mail Options

Select this option to set up an E-mail account.

### Receiving settings in text message

-  It may be possible to receive the E-mail settings in a text message directly from your network operator/service provider.

#### *Request settings from Sony Ericsson*

- 1 Use a PC to go to ***www.SonyEricsson.com*** and select your region. Use the configurators to request that a text message be sent to your phone with the settings you need.
- 2 ▶ Yes to install the new settings when the message arrives.  
The settings will be entered automatically.

### Set account

Set an account to be used for E-mail. If you have several E-mail accounts, you can set one of them as default. If no account is available, you are prompted to set a new account (➡ **54 Editing account**).

Make sure you have created a data account before setting up an E-mail profile ➡ **88 Data accounts**.

#### *Editing account*

- 1 ▶  Messaging ▶ E-mail ▶ Options
- 2 ▶ Edit account ▶ New account
- 3 Enter the account name (for example, Home).
- 4 Enter the following options by pressing Select:
  - ▶ Connect using: The data account you wish to use with this E-mail account.
  - ▶ Protocol: POP3 or IMAP4

- ▶ **Incoming server:** The name or IP address of the server provider for incoming E-mail (for example, mail.server.com or 10.1.1.1.).
  - ▶ **Incoming port:** The number of the port for the mail server. It is not necessary to change from the default 110.
  - ▶ **Mailbox:** A user name for your E-mail account.
  - ▶ **Password:** A password for your E-mail account. Your service provider may alternatively request a password on connection.
  - ▶ **Outgoing server:** The name or IP address of SMTP server for sending E-mails.
  - ▶ **Outgoing port:** The number of the port for the SMTP server. It is not necessary to change from the default 25.
  - ▶ **E-mail address:** Your E-mail address.
  - ▶ **Download:** Whether to receive headers and text or headers only.
  - ▶ **From name:** Your name.
  - ▶ **Signature:** If you wish to add your business card to your E-mails.
  - ▶ **Copy outgoing:** If you wish to send the copy of E-mails to an E-mail address.
  - ▶ **Check interval:** Set the amount of time allowed to connect to your E-mail server.
- 5 ▶ Save to confirm the setting.



If you do not have an E-mail service, contact your operator to get all necessary settings.

### Chat

►  Messaging ► Chat



You can have a chat using your Z600. You can select the nickname (► **57 Area info**) that will appear in the recipient's display each time you send a chat message.

#### *Starting a chat session*

- 1 ►  Messaging ► Chat ► Start new
- 2 Enter the recipient's phone number, or retrieve it from the Phonebook by pressing Look up.
- 3 Write your message and press Send.

#### *Receiving a chat session invitation*

- 1 When you receive a chat session invitation, you hear a beep (editable ► **58 Message alert**) and see the message Chat message, Chat now? appears while in standby mode.
- 2 ► Yes to read the chat message or  
► No to reject.
- 3 Write your chat message reply.

- 4 ► Send to send your chat message or press  to suspend a chat session (►  Messaging ► Chat ► Resume to resume a chat session).
- 5 Press and hold  to end a chat session.



If you receive a new chat message while another chat session is ongoing, press Yes to end the ongoing session and start the new one.

#### *Entering Nickname*

- 1 ►  Messaging ► Chat ► Nickname
- 2 Enter your nickname (maximum of 11 characters) and press Ok.



## WAP push

►  Messaging ► WAP push

You can receive 2 kinds of messages, Content Push (message, comprised of WAP service or service link) and Setting Push (configuration data for WAP, MMS, E-mail settings). When a new message arrives, you will hear a beep which sounds different from the single beep of the ringer and see  in standby mode.

## Inbox

Select this option to read received messages.

## Clear inbox

Select this option to delete messages in the inbox.

## Allow push

Select **On** or **Prompt** if you wish to receive service information messages.

## Area info

►  Messaging ► Area info

-  Receive an area information like weather reports, traffic reports, etc. broadcast to a group of phones in a certain area (network dependent). When you receive this message, the message automatically appears in the display. You cannot save area messages.

## Reception

Set this option **On** to receive an area information.

## Message list

Select this option and **New code** to enter an area information code.

## Cell information

-  The cell information channel is used by some network operators to send messages to their subscribers within a certain network area. Set this option **On** to turn on the channel.

### Options

►  Messaging ► Options

You can set up your voice mail number and message alert.

#### Voice mail number

Enter your Voice mail no. ► **50 Call voice mail.**

#### Message alert

Set the alert type from Silent, Click or Tone.



## My shortcuts

*Creating your own Shortcuts menu.*

You can place your favourite functions that you wish to reach quickly and easily in the **My shortcuts** menu. To select profile ► **94 Profiles.**

*Selecting a menu item in Shortcuts menu*

1 ►  My shortcuts ► Edit shortcuts.

2  to highlight the desired function and press Check or press  to select the function.

3 Enter the position number you wish for this function in your shortcuts menu and press Ok.

4 Press Save to exit the list.



## Calls

*Call options (configuring call conditions).*

### Missed calls



If you have missed a call, the message, **Missed calls**: appears in standby mode, indicating the number of missed calls. Press **Yes** to display missed calls and **Call** to call the number.

### Call list

►  Calls ► Call list

-  Provides a record and quick access of up to 30 of the last outgoing calls, up to 10 of the last incoming calls and up to 10 missed calls. Caller ID (Caller Line Identification) of a caller is required to support Call list entries. When the Call list reaches its capacity, the oldest number is deleted automatically to provide space for the new entry. (This feature is dependent on your network operator/service provider.)

*To display and call a number*

- 1 ►  Calls ► Call list
- 2  to highlight a name/number you wish to call and press **Call** to call a number.



As a short cut, you can also press **Calls** in standby mode to display the entire Call list (to delete the entire list, ► **65 Options**).

Date displayed in the Call History is the same as the format selected in **Time and date** ► **95 Time and date**.

### Divert calls

►  Calls ► Divert calls

-  You may need to register for this service with your network operator/service provider. Sometimes a divert option is automatically set by the network operator.

### Setting a Divert

- 1 ▶  Calls ▶ Divert calls
- 2 Select a call category and then a divert alternative ➡ **60 Divert options.**
- 3 ▶ Activate
- 4 Enter the phone number to which you wish your calls to be diverted and press *Ok*, or retrieve it from the Phonebook by pressing *Look up*.
- 5 Wait for confirmation from the network.



In step 3, you also have the option to cancel or get status.

If the returned response is *Command error*, the network was unable to set, clear or check the selected Divert.

When the *Restrict calls* function is on, some Divert calls options cannot be activated.

### Divert options

- ▶ **Voice calls:** Divert incoming call on a different condition:
  - ▶ **Divert always**  
Divert all calls unconditionally (the phone will not even ring).
  - ▶ **When busy**  
Divert incoming calls when you are on the phone (line engaged).
  - ▶ **Not reachable**  
Divert incoming calls when your phone is switched off or out of network coverage.
  - ▶ **No reply**  
Divert incoming calls if you do not answer the call after a certain period of time.
- ▶ **Fax calls:** Divert all fax calls (the phone will not even ring).
- ▶ **Data calls:** Divert all data calls (the phone will not even ring).
- ▶ **Check all:** Check all divert settings.

## Manage calls

►  Calls ► Manage calls

Select this option to activate/set up call options.

### Call Waiting

If activated, your phone will alert you (beep) when a call is waiting so that you don't miss any calls. Select **Activate**, **Cancel** or **Get status**.

### Accept calls

Restrict incoming calls to only from certain numbers. The rejected phone numbers are saved in the **Call list** ► **59 Call list**.

*Adding numbers to accepted callers list*

- 1 ►  Calls ► Manage calls ► Accept calls ► Accepted list ► New
- 2 Select a contact from the Phonebook or Groups.



► Calls ► Manage calls ► Accept calls ► Accept options to set an accept option.

## Restrict calls



Limit calls made from your phone, for example, if you lend your phone to someone else but do not wish them to make international calls. The restrictions in the **Restrict calls** menu require the **Restrict calls password**. If you divert incoming calls, you cannot activate some **Restrict calls** options.

► **All outgoing**

Restrict all outgoing calls except emergency calls (112, etc.).

► **Outgoing intl**

Restrict all international calls.

► **Outgoing intl roam**

Restrict all outgoing international calls except those to your home country.

► **All incoming**

Restrict all incoming calls.

► **Inc. when roam**

Restrict all incoming calls when you are outside of coverage from your registered network operator (for example, when abroad).

### ► Cancel all

Cancel all settings of the restrict call service.

### ► Change password

Change the Restrict calls password.



## Closed groups

-  The Closed User Group function is a way of lowering call costs. On some network it is cheaper to make calls within a call group. You can save 10 groups.

### *Adding a group*

- 1 ►  Calls ► Manage calls ► Closed groups ► Edit list ► New group
- 2 Enter the name of the user group and press Ok.
- 3 Enter the index number and press Ok. (The index number is provided by your network operator/service provider.)

### *Activating a group*

- 1 ►  Calls ► Manage calls ► Closed groups ► Edit list
- 2 Select a group.
- 3 ► Activate (Calls can only be made within the selected group.)
- 4  to go back to the Closed groups option.
- 5 ► Open calls ► On to call outside a closed user group.

## Open to answer

-  Calls ► Manage calls ► Open to answer
- Answer an incoming call by opening the phone and end a call by closing it. Set this option on/off to activate/deactivate the active open to answer option (the default is On).

## Default priority

►  Calls ► Default priority

-  You can request a certain priority when you make a call, if your subscription supports the call priority service. The priority levels are defined by your network operator/service provider and are normally within the range of 0-4, where 0 is the highest priority. Select this option to receive available priority levels and then select a priority level.

## Time and cost

►  Calls ► Time and cost

-  Track or control how long you are on the phone and the cost of calls/data transmission made. Call/GPRS costs can be used as a security measure, for example, when you lend your phone to someone, you must use your PIN2 as a security code when you set or change the call cost options.



## Call timers

Check the length of your last call, total calls (incoming and outgoing) and outgoing calls. Select **Reset timers** and **Total time/Outgoing time** to reset the total/outgoing call time. Turn **Minute minder** on to hear the beep every minute during calls.

## Call costs

Check the cost of your last call, total calls, remaining credit and limited credit.

### *Setting credit and tariff*

-  Calls ► Time and cost ► Call costs ► Set credit to set a unit figure at which your phone will not allow any more calls to be made. When the amount reaches 0, no more calls can be made. Enter your PIN2 at the prompt and set the charge limit ➡ **111 PIN2**.
-  Calls ► Time and cost ► Call costs ► Set tariff to set the currency and price per unit which will be used to calculate the call cost. Enter your PIN2 at the prompt ➡ **111 PIN2**.

Enter a currency and the price per unit (to enter a decimal point, press  *a/a* ).



In order to be able to make phone calls again, reset the *Credit counter* or set the credit to *Unlimited*.

### Calling cards



You can use the calling card service to redirect the cost of a call (voice call only) to a credit card or a calling card account.

You can save 2 separate calling card numbers.

The numbers and the codes associated with them are protected by the code. The numbers and the codes are provided by your network operator/service provider.

To avail the Calling cards option, you first need to turn this option on ➔ **64 Use calling cards**.

### *Using My cards*

- ▶  **Calls** ▶ **Time and cost** ▶ **Calling cards**  
▶ **My cards**
- ▶ Enter your phone lock code and press **Ok**.
- ▶ **New card** to enter the card settings and select which you wish to send first (the number you wish to call or the verification code).  
or  
Select a card followed by **Activate card** to select a card.

### *Use calling cards*

Select this option and enter your phone lock code (➔ **97 Phone lock**) to turn the calling card service on/off.



### *To make a calling card call*

- 1 Enter the phone number using the keypad or retrieve a number from the Phonebook.
- 2 Press **Call**.  
The access number of the calling card server is called. During the connecting phase, you are asked to send the phone number you wish to call and the verification code.
- 3 The message, **Send called number?** appears. Press **Yes** or wait a moment to send the number and code.

### SMS counter

Check the number of sent SMS.

Select **Reset counter** to reset the SMS counter.

### Data counters

Check the volume of your last and total data connection.

Select **Reset counter** to reset the Data counters.

### Next call

►  **Calls** ► **Next call**

#### Next incoming call

Specify the type of the next incoming call. The setting remains until you change it next time. The default setting is **Voice call (SIM dependent)**.

#### Call and hide/show ID

You can hide/show your phone number when making a call. Enter the phone number you wish to call and select **Call and hide ID/Call and show ID** (network dependent).



You can also set a next call type by pressing **More** and selecting **Call and hide ID/Call and show ID** after entering a phone number.

### Options

►  **Calls** ► **Options**

Select **Clear call list** to delete all call list entries and **Call listing** to turn the call list option on/off.



## Camera

*Using the integrated camera.*

Your phone has a digital camera. You can take pictures, save and view them and send them via E-Mail or MMS (Multimedia Message Service).



Before you send a picture using E-Mail or as a picture message, you need to avail these services ➤ **50 E-mail**, ➤ **47 Picture Message (MMS)**. The phone that you are sending the picture needs to support data transmission and MMS in order to receive and show the picture.



You can also use a picture as a screen saver or as wallpaper (➤ **93 Screen saver**, ➤ **93 Wallpaper**), or save it together with a contact in your Phonebook so that the picture appears when that person calls ➤ **39 Adding a picture to a contact**.

## Options

When the camera is activated, press **More** to select one of the following options:

- ▶ **My pictures** to view all your pictures.
- ▶ **Size** to select the size.
- ▶ **Night mode** to use in poor lighting conditions.
- ▶ **Effects** to select different effects for your picture.
- ▶ **Default name** to create a name for your picture.
- ▶ **Self-timer** to take a picture a few seconds after pressing the camera button.

## Taking a picture

There are different ways to take a picture:

### *Taking a picture using Camera menu*

- 1 ▶  Camera
- 2 Hold the phone as shown in the illustration. You can see the subject in the phone display.
- 3 ▶ Capture to take a picture.

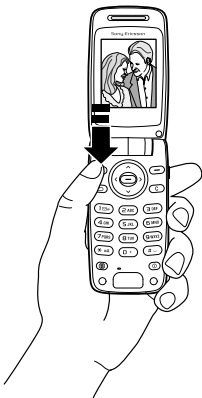

### *Taking a picture using the camera button*

On the side of the phone, press the camera button to activate the camera. Hold the phone as illustrated below. You can see the subject in the phone display. Press the camera button again to take the picture.

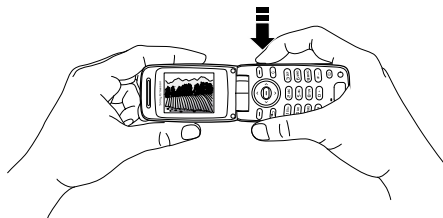

 Do not take a picture directly of the sun; this could cause serious harm to your eyesight, damage your product or cause a discolouration of pictures.

### Taking a self-portrait

It is possible to take a self-portrait. Hold the phone as illustrated below. You can see your reflection in the mirror. On the side of the phone, press the camera button to activate the camera. Press the camera button again to take the picture.

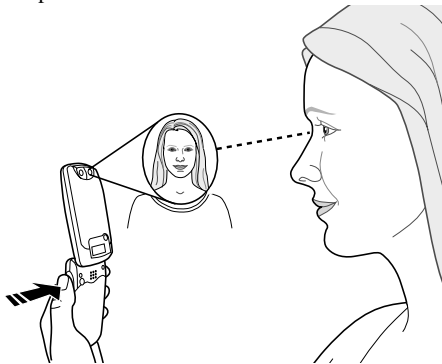

⊖ repeatedly to take a succession of pictures.

⊕ or ⊖ to adjust the picture brightness.

### Saving and deleting pictures

When you have taken a picture, ⊖ to save it in My pictures ➔ **69 My pictures**. If the message, Memory full appears, you cannot save any more pictures until you have deleted an item from the phone memory.

### *Sending a picture*

- 1 ▶ 📷 Camera
- 2 Take a picture.
- 3 ▶ Send and create your picture message  
➔ **47 Picture Message (MMS)**.

## Pictures & sounds

*Selecting, Composing, Recording sounds and pictures.*

The Pictures & sounds menu allows access to a variety of Picture and Sound functions.

### My pictures

▶  Pictures & sounds ▶ My pictures

All pictures and animations are saved in My pictures. You can add, edit, or delete pictures. The number of pictures that can be saved depends on the size of the pictures. File types supported are GIF, JPEG and WBMP.

To view pictures, press *View*.

#### *Editing and saving a picture*

- 1 ▶  Pictures & sounds ▶ My pictures
- 2 Scroll to the picture you wish and press *More*.
- 3 ▶ *Edit* to edit a picture. ➤ **70 Picture editor.**

- 4 ▶ *More* again and select *Save picture* to save the picture in My pictures.



To edit pictures taken with the camera, you must select 120 x 160 as picture size.

### Exchanging pictures

You can exchange pictures via Bluetooth, the infrared port, picture message or E-mail. For more information on sending pictures in messages ➤ **43 Messaging**. Save the E-mail address of a WAP album in your Phonebook and you can save pictures in that album if you send the pictures as attachments.

#### *Sending a picture*



- 1 ▶  Pictures & sounds ▶ My pictures
- 2 Scroll to the picture you wish to send and press *More*.

- ▶ Send and select the transfer method from the following options: As picture msg, As e-mail, Via Bluetooth or Via infrared.

 You are not allowed to exchange copyright protected material.

### *Receiving and saving a picture*

- ▶  Connectivity ▶ Bluetooth/Infrared port  
▶ Turn on or  
▶ More ▶ Turn on Bluetooth/Turn on infrared in standby mode.
- ▶ Save when you receive the picture.  
The picture will be saved in My pictures.

 When you receive a picture in a message,  to highlight the picture and press *Save* to save it.

### More pictures

- ▶  Pictures & sounds ▶ More pictures  
Select this option to download a picture  
➡ **85 Downloading items.**







## Picture editor







- ▶  Pictures & sounds ▶ Picture editor  
You can create your own picture.

### *Drawing picture*

- ▶  Pictures & sounds ▶ Picture editor
- Select a type.
- Select Tool and the tool you wish to work with.
- When editing or drawing a picture use the keypad for the following functions:

Press	Function
-------	----------

- |   |                                    |
|---|------------------------------------|
|  | move the cursor up and left.       |
|  | move the cursor up.                |
|  | move the cursor up and right.      |
|  | move the cursor left.              |
|  | activate the current drawing tool. |
|  | move the cursor right.             |

Press	Function
	move the cursor down and left.
	move the cursor down.
	move the cursor down and right.
More	save, preview, open a picture or start a new picture.
	press and hold to exit the picture editor.
	undo the last action.
	select tool.
	select a colour.

## Themes

►  Pictures & sounds ► Themes

Change the appearance of the display. Your phone comes with pre-set themes. You cannot delete some of these, but you can download new themes.

Pressing **More** offers you the following options: Send, Delete, Rename, view Theme info and Memory status.

## More themes

►  Pictures & sounds ► More themes

Select this option to download a theme

► **85 Downloading items.**

For more information, visit [www.SonyEricsson.com](http://www.SonyEricsson.com) or [wap.SonyEricsson.com](http://wap.SonyEricsson.com).

### *Sending a theme*

Follow steps 1-3 in ► **69 Sending a picture** and select Themes in step 1.

### *Receiving and saving a theme*

► **70 Receiving and saving a picture.**

The theme will be saved in Themes.

## My sounds

▶  Pictures & sounds ▶ My sounds

Select **My sounds** to access ring signals. You can play, send, rename these sounds.

### *To listen to a sound*

- 1 ▶  Pictures & sounds ▶ My sounds
- 2 Highlight a sound you wish to hear and press **Play**.

### *Sending a sound*

- 1 ▶  Pictures & sounds ▶ My sounds
- 2 Highlight a sound you wish to send.
- 3 ▶ **More** ▶ **Send**
- 4 Select a transfer method.

### *Receiving sounds*

▶ **70 Receiving and saving a picture.**

The sound will be saved in **My sounds**.

### *Deleting or Renaming a sound*

Follow steps 1-3 in ▶ **72 Sending a sound** and select **Delete** or **Rename** in step 3.

## More sounds

▶  Pictures & sounds ▶ More sounds

Select this option to download sounds such as ring signals ▶ **85 Downloading items.**

## Music DJ

▶  Pictures & sounds ▶ Music DJ

Compose your own melody.

### *Composing melody*

- 1 ▶  Pictures & sounds ▶ Music DJ
- 2 Choose to insert a selection of pre-recorded music blocks. You can select from 4 different selections.
- 3 Copy and paste these blocks to build up your melody.
- 4 ▶ **More** to play the melody and view other options.



Select **Save melody** in step 4 to save your own melody in **My sounds**.



## Record sound

►  Pictures & sounds ► Record sound

Record and play your own memos or ongoing calls ► **95 Voice control.**

### *Recording a sound*

- 1 ►  Pictures & sounds ► Record sound
- 2 When the recording starts, the message Recording and the time of the current recording appear in the display.
- 3 ► **Stop** to end recording. The recording will automatically stop if you receive an incoming call or when the call ends. (The recorded sound is saved in *My sounds*.)



You are responsible for the confidentiality of the recording.

You must seek the permission of the person you are calling before recording.



## Connectivity

*WAP, Bluetooth, Synchronization, etc.*

### Online services

►  Connectivity ► Online services



Online services are customised services offered by network operators (network dependent), independently of mobile phones and mobile manufacturers. A SIM card which supports Online services works in the same way as a normal SIM card. When you have inserted your SIM card and turned on your phone, your network operator can download data to your SIM card. When you restart your phone after the first data download, a new submenu appears under the menu. Select this option to enter your new menu system.

### SAT (SIM Application Toolkit)

-  When access to network-specific functions (SAT) is available, the SAT menu is displayed in Menu overview. This feature is dependent on your network operator and may not be supported by some networks.

### Bluetooth™

►  Connectivity ► Bluetooth

Your Z600 has built-in Bluetooth™ wireless technology which supports the following applications:

- Dial-Up
- PC Applications
- Item Exchange  
    ➡ **75 Item Exchange**
- Bluetooth Handsfree  
    ➡ **26 Bluetooth headset**

 Please check for any exceptions, due to national requirements or limitations, in usage of Bluetooth equipment before using this product.

### Getting started

To synchronise with your PC, and to browse the Internet, you also need to install software on your PC from the Sony Ericsson web site, [www.SonyEricsson.com/support/](http://www.SonyEricsson.com/support/). You can exchange items or play games without having to add the other device to the list of My devices.

### Turn on

Select this option to turn on/off the Bluetooth. You can also turn on/off the Bluetooth by pressing **More** in standby mode and selecting **Turn on Bluetooth/Turn off Bluetooth**.

### My Devices

To communicate with another Bluetooth device, you first need to add the device to the list of my devices.

### *Adding a device to your phone (My device)*

- 1 ▶  Connectivity ▶ Bluetooth ▶ My devices
- 2 ▶ New device to search for all types of available devices or  
▶ More to select a specific type of device to search for. Wait for a connection from remote devices.
- 3 A Searching message is displayed.  
(If no connection request comes within 3 minutes, your phone will return to My devices option.)
- 4 A name of available devices such as PC, PDA, Mobile Phone, Headset or Other is displayed.
- 5 Enter a passkey (up to 16 digits) for the device, both in phone and, for example, in the PC. (If a passkey does not come with the Bluetooth device when you buy it, you need to create one yourself.)

- 6 ▶  Connectivity ▶ Bluetooth ▶ My devices and select a device from the list followed by More to view a list of options.



We recommend that your phone and the Bluetooth device you are communicating with are within a range of 10 metres.

You can stop the connection at any time by pressing Cancel.

When Bluetooth is activated,  is displayed.

### Item Exchange

It is possible to exchange items with other Bluetooth devices supporting item push profile.

You can send/receive the following items:

- Own Business Card (My card) or contacts from the Phonebook ➤ **38 Sending your business cards**, ➤ **37 Sending contact**.
- Calendar overview/appointments/tasks ➤ **100 Advanced Options**.
- Pictures ➤ **68 Sending a picture**, Themes ➤ **71 Sending a theme**.

### *Sending an item*

- 1 Select an item you wish to send (for example, ➔ **38 Sending your business cards**) and select Bluetooth as the transfer method.
- 2 A list of possible receivers is displayed.
- 3 Select a device to which you wish to send



If the list of receivers is empty, your phone will automatically start searching devices.

- 4 A **Connecting/Sending...** message is displayed.

### *Receiving an item*

- 1 From standby mode, press **More** and select **Turn on Bluetooth** or **Turn on infrared**.
- 2 A message with item/device information is displayed.
- 3 ▶ **Yes** to save an item or  
▶ **No** to discard the received item (if you do not make any choice within 3 minutes, the item is automatically discarded).

### **Handsfree**

This option offers you to add a Bluetooth handsfree to your phone and/or choose the sound transferring method.

### *Adding a Bluetooth handsfree*

- 1 ▶  Connectivity ▶ Bluetooth ▶ Handsfree
- 2 The message, Add a handsfree device to use with phone?, is displayed.
- 3 ▶ Yes to add a hands free or  
▶ No to cancel this option.



If you connect the cable headset or the car kit to the phone, the Bluetooth headset is immediately deactivated.

Once the headset is activated,  is displayed.

Please also see the Bluetooth Headset user manual.

### *Selecting a sound transferring method*

- 1 ▶  Connectivity ▶ Bluetooth ▶ Handsfree  
▶ Ongoing call
- 2 Select from the following options:  
In phone or Always ask.

### Options

You have the following Bluetooth options:

- ▶ **Visibility:** You can choose if your phone can be found by other Bluetooth devices when using Bluetooth. Select **Show phone/Hide phone** to show/hide your phone.
- ▶ **Phone name:** You can select a name for your phone. This name is displayed in other devices when your phone is found, and is also for the infrared port.
- ▶ **Phone services:** Display supported services.

### Infrared port

#### ▶ Connectivity ▶ Infrared port

You can use the built-in infrared port to establish contact between your phone and a PC or another device equipped with an infrared port.

#### *Activate the infrared port*

- ▶  Connectivity ▶ Infrared port
- ▶ On to activate the infrared port or  
▶ 10 minutes to activate the infrared port for only 10 minutes.



Select **Off** in step 2 to turn off the infrared port.

You can also activate the Infrared port by pressing **More** in standby mode and selecting **Turn on infrared**.

### *Connecting 2 devices*

- Place your phone as in the picture. The infrared port on the phone must face the infrared port on the other device. If you are connecting to a PC, make sure your PC has activated infrared communication.

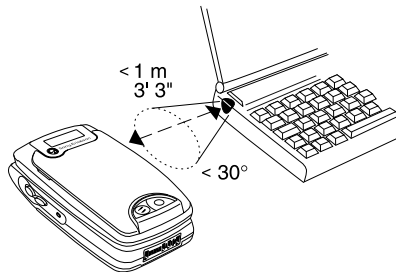

- Your phone now establishes contact with the other device.

## WAP options

►  Connectivity ► WAP options

WAP (Wireless Application Protocol) allows access to a variety of useful information.

 To avail of WAP service you must first register with your network operator/service provider to ensure that your subscription allows access to these services. In some cases registration has already been completed.

Once registered with your network operator/service provider you will be provided with the specific parameter settings required to access WAP. It may also be possible for you to obtain these parameters in a text message or from the web page of your network operator/service provider (► **54 Receiving settings in text message**) and the settings are also available at [www.SonyEricsson.com/](http://www.SonyEricsson.com/).



As a safety measure, a Security Code may be necessary to change the settings of your browser. Use the code that is set as your Security Code

► **82 Security.**

Your browser can display pages in the most common formats on WAP and Websites (WML and HTML) as well as iMode site (cHTML).

You cannot make phone calls while accessing the mobile Internet.

## Getting started

Before you use WAP, via a WAP service provider, you will need to set a specific data account for WAP and a WAP profile

► **80 Receiving settings in text message** or

► **80 Creating profile settings manually.**

## Receiving settings in text message

-  It may be possible to receive the WAP settings in a text message directly from your network operator/service provider ➤ **54 Request settings from Sony Ericsson.**

### WAP Profile

You can manually enter or edit existing settings information from your network operator/service provider. Make sure you have created a data account before setting up a WAP profile

#### ➤ **88 Data accounts.**

#### *Creating profile settings manually*

- 1 ▶  Connectivity ▶ WAP options  
▶ WAP profiles ▶ New profile
- 2 Enter a profile name and press Ok.
- 3 ▶ Connect using ▶ Edit
- 4 ▶ New account and select an account type (GSM data or GPRS data).

#### 5 Enter the following option:

- |                             |   |
|-----------------------------|---|
| ▶ Name:                     | A name for the data account   |
| ▶ Phone no:<br>or<br>▶ APN: | The phone number of your Internet Service Provider or the address of the external data network you wish to connect to, either an IP address or a text string. |
| ▶ User id:                  | Your user ID to log on to the external data network.  |
| ▶ Password:                 | Your pass word to long on to the external data network.   |
- 6 ▶ Save to save the new data account.
  - 7 Select the new data account to be used.
  - 8 ▶ IP address: ▶ Edit



9 Enter IP address for the gateway and press Ok.

10 ▶ Save to save the new profile.



To edit the data account ▶ **88 Data accounts.**

### *Editing profile settings*

- 1 ▶  Connectivity ▶ WAP options  
▶ WAP profiles and highlight a profile you wish to edit
- 2 ▶ Edit for following options: Rename, Connect using, IP address:, Advanced and Delete.

Advanced function allows you to set the following options:

- |                    |   |
|--------------------|---|
| ▶ Change homepage: | Enter the address of the WAP site you wish to have as you homepage. |
| ▶ Second account:  | Select an alternative data account, if the first fails.             |
| ▶ User id:         | Enter your user ID for the WAP gateway.                             |
| ▶ Password:        | Enter your password for the WAP gateway.                            |
| ▶ Security:        | Turn on a secure connection on/off.                                 |
| ▶ Show pictures:   | View pictures while browsing.                                       |

### Security

Your phone has support for WAP secure browsing. When you turn on security, the connection between your phone and the WAP gateway is secure.

Establish a secure connection when using certain WAP services such as banking or WAP shopping, you need certificates in your phone. You have the following security options:

▶ **Trusted certificates:**

Select a trusted certificate from the list. You can also download trusted certificates from [www.SonyEricsson.com/](http://www.SonyEricsson.com/).

▶ **Client certificates:**

Check the certificates in your phone.

▶ **Contracts:**

You can sign a contract with your phone by entering a digital signature PIN. Digital signature records can be traced back to your private key through a certificate that is used for signing a contract. All transactions (signed contracts) made with your phone when browsing are stored in your phone. Select **Contracts** to check your contracts.

▶ **Locks:**

The security module is located on the SIM card, if your network operator/service provider supplies such a service. It can contain both certificates and your private keys. The security module is protected by a special access PIN and your phone asks you for it when establishing a secure connection:

▶ **Access lock:** Enter the access PIN (for the security module) and the signature PIN.

▶ **Protection:** Turn this option on to set if PIN check should occur after powering the phone.

▶ **Change PIN:** Enter or Edit the access PIN and the signature PIN.

## Cookies

- ▶ Allow cookies to accept Cookies function.
- ▶ Clear cookies to delete Cookies function that offers privacy and protects against site bugs. It is recommended to clear any sensitive information about previously visited WAP services. This is to avoid a security risk if your phone is misplaced, lost or stolen.

## Passwords



Turn this option on/off to save/not save passwords. To save or delete passwords, select Remember pwds or Clear passwords.

## Clear cache

Delete cache from your phone.

## Using WAP

- 1 ▶  Connectivity ▶ WAP options  
▶ WAP profiles
- 2 Select a profile you wish to use. The phone will automatically return to WAP options menu.

- 3 ▶  Internet services or press the . When the WAP page is loaded into the phone, press More and select from the following:

- Select a name to open your homepage (for example, SonyEricsson).
- Select Bookmarks to go to one of your bookmarks.
- Select Enter address to enter the address of a WAP or select one of the 10 most recently entered addresses.

- 4 ▶ More ▶ Exit WAP to exit WAP menu.



When you enter a WAP address, the normal http:// prefix is not needed.

## Bookmarks

You can save up to 25 bookmarks (alphabetical order). Do not save passwords for sensitive sites, such as online banking. If a password is saved, the risk of unauthorised use of your phone and sites is greater.

Select **New bookmark** and enter the title and address using the keypad. Press **Ok** to save your entry.

### *Using a bookmark*

- 1 ▶  Internet services ▶ More ▶ Bookmarks
- 2 Highlight a bookmark.
- 3 ▶ More and select one of the following options:
  - ▶ **Go to:** Go to the marked WAP address.
  - ▶ **Edit:** Edit the title and/or address.
  - ▶ **Delete:** Delete the bookmark.
  - ▶ **Send as text msg:** Send a link to the WAP address in a text message.
  - ▶ **Send:** Send a link to the current WAP address via Bluetooth or infrared.
  - ▶ **Set as homepage:** Set the WAP address as the home page.

## While Browsing

▶ More while browsing, for the following options:

- ▶ **Name:** Go to the home page for the current profile /Access the URL site of the current default setting.
- ▶ **Bookmarks:** Add the site to your bookmarks, or see the list of bookmarks for the current profile.
- ▶ **Enter address:** Enter the WAP address using keypad.
- ▶ **Save picture:** Save a picture from the site.
- ▶ **Send as text msg:** Send a text message with a link to the current WAP page to another phone.
- ▶ **Send link:** Send a link to another phone via Bluetooth or infrared.
- ▶ **Reload:** Refresh the contents of the WAP page.

- ▶ **Exit WAP:** Disconnect and return to standby.
- ▶ **Status:** Display current status information such as profile, access type, connection time, data rate, security, address.
- ▶ **Set as homepage:** Set the current site as the home page of WAP profile you are using.



If you select an E-mail address when browsing, you can reply with a text message.

## Downloading

You can download pictures, themes, games and ring signals from internet and/or WAP sites.

### *Downloading items*

- 1 Start the WAP and access a site that offers downloading items.
- 2 Click on the link provided by the internet/WAP site to start downloading. The phone will automatically guide you through the installation process of the newly downloaded items.

## Synchronization

▶  Connectivity ▶ Synchronization

You can synchronise the Calendar and Phonebook in your phone with similar programs in, for example, a PC, PDA, or mobile phone and with similar programs on the Internet.

Before you start the synchronization, you need to do the remote settings ➡ **86 Setting up the remote settings.**

### Synchronization with nearby devices



After installing the synchronization program from the Sony Ericsson WAP site, [www.SonyEricsson.com/support/](http://www.SonyEricsson.com/support/), you can synchronise your phone with your PC. A status bar shows the progress of the synchronization. If you use a cable, the synchronization starts as soon as you connect the cable. For more information, please refer to the synchronization software online help.

## Internet synchronization

You can synchronise your phone contacts, appointments and tasks with similar programs on the Internet, using WAP ➡ **79 WAP options.**

 In order to use these programs on the Internet you need the user ID, password and addresses for the different programs. You must also have a WAP profile set in your phone.

### *Setting up the remote settings*

- ▶  Connectivity ▶ Synchronization ▶ Options ▶ Remote settings
- ▶ Remote login and
  - ▶ WAP profiles to select the WAP profile or add a new one if no profile exists.
  - ▶ Sync. server to enter the user ID, password and server URL.
- Press  to go back to the Remote settings menu.
- ▶ Applications ▶ Phonebook or ▶ Calendar and enter database path, User ID and password.

- 5 Press  2 times to go back to the Options menu.
- 6 ▶ **Sounds** to turn the sound on (off) to alert (not to alert) when an error occurred or the synchronization is completed.

### Remote sync.

Start the synchronization:

- ▶ **Start** to start a remote synchronization.
- ▶ **Applications** to select an application to be synchronised.

### GSM Networks

▶  **Connectivity** ▶ **GSM Networks**

Select a network automatically when you switch on your phone, or manually from a list of available networks.

### New search

Search for available networks.

### Select network

Select a network from a list of available networks.

### Search mode

Set the search mode to **Automatic** or **Manual**.

### Preferred networks

Edit the automatic network selection priority list. This feature is helpful, for example, to priorities roaming partners. Select from the following options:

- ▶ **New network** to add a network operator to the list.

- ▶ **Change priority** after selecting a network from the list to adjust the network priority.
- ▶ **Full name** to display full name of the network operator
- ▶ **Delete** to delete a network from the list.

### Data comm.

- ▶  Connectivity ▶ Data comm.

In order to access to an Internet server at your service provider, you first need to set up the data account.

### Data accounts

You can have several data accounts saved in your phone with different settings for different purposes. The main setting for a data account (GSM/GPRS) is the connection method.

You can create a new data account or edit an existing data account.

Please contact your network operator for charging details.

### *Creating a new data account*

- ▶  Connectivity ▶ Data comm.  
▶ Data accounts
- ▶ New account ▶ Add
- ▶ GPRS data or ▶ GSM data
- Enter a name.
- Enter APN:/Phone no.; User id: and Password (for detail information ➡ **88 Editing a data account**).
- ▶ Save to save the new account.

### *Editing a data account*

- ▶  Connectivity ▶ Data comm.  
▶ Data accounts
- Select a data account.
- ▶ Edit
- Enter the following option:
  - ▶ **Phone number:** The phone number of your Internet service provider.



- ▶ **APN:**  
(GPRS only) The address of the external data network you wish to connect to, either an IP address or a text string.
  - ▶ **User id:** Your user ID to log on to the external data network.
  - ▶ **Password:** Your password to long on to the external data network.
  - ▶ **Password request:** If you wish to be asked for a password each time you log on to the external data network.
  - ▶ **Data rate:**  
(GSM only) The speed for the connection.
  - ▶ **Dial type:**  
(GSM only) Analog or ISDN connection.
  - ▶ **Allow calls:**  
(GPRS only) Allow calls during GPRS connection or not.
  - ▶ **IP address:**  
(GPRS only) The IP address that the phone uses when communicating with the network. (If you do not enter an address, the network provides you with a temporary IP address.)
  - ▶ **DNS address:**  
(GPRS only) The IP address to the DSN server.
  - ▶ **Advanced settings:**  
(GPRS only) These are optional. Consult your network operator whether your connection needs these settings.
- 5 Repeat step 4 for other settings.  
Press **(C)** to delete an account.

### Pref. services

Select your preferred data transfer method from GPRS and GSM or GSM only.

### SMS access

Select if you wish the SMS be sent using GSM or GPRS.

### Fax and data calls

To send fax messages and make data calls, you need to connect your phone to a computer, and then start the appropriate software program.

### Receive fax and data calls

-  The procedure of receiving fax messages and data calls depends on your network and subscription. If you have separate number for voice, fax and data calls, your phone recognizes the type of call.

### Receive a fax/data call (separate numbers)

- 1 Connect your phone to a computer.
- 2 Answer the call from within the software program (if it does not answer automatically).  
You cannot answer a fax or data call by pressing **Yes** on the phone.

## Accessories

►  Connectivity ► Accessories

View the list of accessories which are currently connected to your phone.



## Operator direct link

*Accessing Operator defined direct links.*



Operator direct link menu provides you with a easy access to operator defined direct links.

Simply select this option or press  to access the direct link or download items such as sounds, pictures, etc.



## Internet services

*Accessing an online web page.*

Selecting this option brings you to an online web pages.



# Settings

*Personalising your phone settings.*

## Sounds and alerts

▶  Settings ▶ Sounds and alerts

Customise signals such as ring signals and different types of alerts.

### Ring Volume

Select from 6 ringer volume levels.



To turn the ring signal (except the alarm and timer) on/off, press and hold **(C)** from standby mode or press **More** and select **Turn on silent/Turn off silent**.  appears in standby mode to remind you when the ringer is switched off.

### Increasing ring

Select **On** when you wish the ring signal to rise in steps from the lowest volume to the highest.

### Ring signals

Select from the different ring signals. To download a ring signal ➡ **85 Downloading items**.



If you subscribe to the Two Line Service, you can set different ring signals for the two voice lines. **Line 1** and **Line 2** are displayed instead of **Voice calls**. If your subscription includes the Change Line Identification (CLI) service, you can assign a personal ring signal to up to 10 callers (network dependent) ➡ **39 Personal rings**.

### More ring signals

Select this option to download ring signals ➡ **85 Downloading items**.

### Vibrating alert

Set the vibrating alert to **On/Off** or **On if silent**.

### Alarm signal

Select from the different alarm signals.

### Message alert

Select from the different message alerts.

## Key sound

Set the key sound to **Silent** or **Tone**.

## Minute minder

Switch the **Minute minder On (Off)** to be (not be) reminded by a beep in 1 minute intervals of the time you are on the phone.

## Display

►  Settings ► Display

You can customise the functions related to presentation in the display, for example, Wallpaper, Screen saver, Light, etc.

## Wallpaper

Select pictures as a wallpaper to appear in the display in standby mode. **Set picture** to select a picture and **Activate** to turn the wallpaper function **On/Off**.



You can select Wallpaper by pressing **More** and **Set as wallpaper** when viewing pictures in **My pictures**.

To download a wallpaper, ► **85 Downloading**.

## Start-up picture

Switch off or set a picture that appears when you switch on your phone.

## Screen saver

The phone has a screen saver, which is activated automatically when the phone has been in idle mode for a few seconds. After a few more seconds, the screen saver changes to sleep mode to save power. **Set picture** to select a picture as the screen saver and **Activate** to turn it on/off.

## Themes

► **71 Themes**.

## More themes

► **71 More themes**.

## Light

You can set the display light to **On** or **Automatic**. In automatic mode, the display light is turned off a few seconds after you last press a key.

### Contrast

Adjust the contrast of your display using the Navigation key.

### Edit line tags

-  When you have two voice line service, you can change the name of line.

### Profiles

▶  Settings ▶ Profiles

Your phone has a number of preset profiles which are set to suit a certain environment. You can rename, change and add accessories to these profiles. For example, when you go to a meeting, you can simply select the Meeting profile and a number of settings, such as the ring signal is turned off. You can also change your profile using the voice commands ➡ **96 Voice profiles**.

### Select profile

Select from the different profiles.

### View profile

Display the current profile setting.

### Edit profile

Select this option to edit profiles.

### Reset profiles

Select this option to reset all profile settings.

### Language

▶  Settings ▶ Language

Select the appropriate language for Menus and Input (➡ **32 Input languages**).

## Time and date

▶  Settings ▶ Time and date

The time is always displayed in standby mode.

### *Setting the Time and date*

1 ▶  Settings ▶ Time and date

2 Select one of the following options:

- ▶ Set time: Set a time.
- ▶ Time format: Select a time format from 24 hours and am/pm.
- ▶ Set date: Set a date.
- ▶ Date format: Select a date format from different formats.

3 ▶ Advanced and select one of the following options to set the time zone and daylight saving functions: Time zone, Daylight-saving and Auto time zone.



When your phone changes network, and the time sent out from the operator deviates from the time in your phone, you are asked whether you wish to update the time if you have turned on **Auto time zone**. If you press **Yes**, the time is updated automatically.

## Voice control

▶  Settings ▶ Voice control

This option offers you to control some functions using your voice.

### Voice dialling

Turn the Voice dialling option on/off and edit Voice tags ➡ **23 Voice dialling**.

### Voice redial

Turn the Voice redial option on/off ➡ **24 Voice redialling**.

### Voice answer

Turn the Voice answer option on/off ➡ **26 Voice answering**.

### Caller name

Select whether you wish to hear the recorded contact name when you receive an incoming call from the contact. Select **On/Off** to turn this option on/off.

### Voice profiles

This option offers you to change your profiles with your voice and/or keep all your voice commands up to date by re-recording them or deleting the ones you do not use. Select this option to edit your voice commands.

#### *To turn on and record profile commands*

- 1 ▶  Settings ▶ Voice control ▶ Voice profiles ▶ On
- 2 Instructions appear. Press **Ok**.
- 3 Select a profile.
- 4 Lift the phone to your ear, wait for the tone and say the profile name. Repeat steps 3-4 to record voice commands for the other profiles.

#### *Changing a profile with voice commands*

- 1 In standby mode, press and hold a volume key.
- 2 Lift the phone to your ear, wait for the tone and say profile command for the required profile. The profile command is played back to you and the current profile is changed.

#### *Editing your voice commands*

- 1 ▶  Settings ▶ Voice control ▶ Voice profiles ▶ Edit commands
- 2 Select a voice command you wish to edit.
- 3 ▶ Play voice to listen to a recorded voice command or ▶ Replace voice.
- 4 Lift the phone to your ear, wait for the tone and say the command. You can also edit the voice command for a contact name in **Edit contact** in the Phonebook.



### Sound recorder

Turn the Sound recorder option on/off

➡ **32 Sound recordings.**

### Magic word

Turn the Magic word option on/off ➡ **31 The**

**magic word.**

### Erase all

Delete all voice commands.

## Locks

▶  Settings ▶ Locks

### SIM lock

Select this option to turn the SIM lock on/off and/or change your PIN and PIN 2. For more details on SIM card lock ➡ **111 SIM card lock.**

### Phone lock

The phone lock protects the phone against unauthorised use if it is stolen and the SIM card is exchanged. It is not on when you buy the phone. You can change the phone lock code (default 0000) to any 4-8 digit personal code. Select **Protection** and **On/Automatic/Off** to turn the phone lock on/off (the default is **Off**) or **Change code** to change the code.



If you set to automatic, you do not need to enter your phone lock code until a different SIM card is inserted. Please contact your local Sony Ericsson retailer if you should forget your new code.

### Handsfree

▶  Settings ▶ Handsfree

Set your handsfree mode and type.

### Answering mode

Select the answering mode from **Normal**, **Any key** or **Auto**.

### Handsfree type

Select the handsfree type from **Basic** or **Automatic**.

### Master reset

▶  Settings ▶ Master reset

Reset all of your phone's settings back to the factory settings except Phonebook, Scheduler and Network/SIM card based settings (select **Reset all** if you wish to delete all contacts, messages and other personal data saved in your phone). This will automatically restart your phone (you will need the phone lock code **▶ 97 Phone lock**).

## Organizer

*Calendar, Notes, Alarms, Timer, Stopwatch, Calculator and Code memo.*

### Calendar

►  Organizer ► Calendar

Display the calendar, save your daily schedule and set alarms for important tasks.

The monthly calendar appears as follows: The calendar can also be synchronised with a PC calendar or, using WAP, with a calendar on Web  
 ➡ **86 Synchronization.**

7: Days on which you have appointments are marked in bold.



Apr 2003						
M	T	W	T	F	S	S
	1	<b>2</b>	3	4	5	6
<b>7</b>	8	9	10	11	12	13
14	15	16	17	18	19	20
21	22	23	24	25	26	27
28	29	30				

Select More

### Appointments and tasks

You can save up to 300 appointments and 80 tasks in your calendar, depending on the size of each item. You can choose to add a new appointment/task, or to use an old appointment/task as a template by copying and editing it.

#### *Entering a new appointment*

-  Organizer ► Calendar ► Add appointment and enter the appropriate information in one of the following options: Subject:, Location:, Icon, Start date, Start time, Duration and Reminder.
- Confirm each entry by pressing Ok, Select or Save.

#### *Entering a new task*

-  Organizer ► Calendar ► Tasks ► New task
- Task  
or  
► Phone call
- Enter the task or phone number and press Ok.

- 4 The message, *Set reminder?* appears. Press *Yes/No* to/not to enter the date and time.



When you are in the list of appointments/tasks for a certain day, press *More* to *Edit*, *Delete*, *Reschedule*, *Send* or *Copy*. You can also call a number included in a phone call task.

### *Viewing your calendar*

- 1 ► Organizer ► Calendar
- 2 Select one of the following options:
  - **View today:** View all appointments for today and unfinished tasks.
  - **View week:** Move within and among the days using the *Navigation* key. Press *Select* to view a certain day.
  - **View month:** Move within and days or weeks using the *Navigation* key. Press *Select* to view a certain day.



In the weekly and monthly views, you can go to next week by pressing (⌘ DEF), to next month by pressing (⌘ MNO) and to next year by pressing (⌘ WXYZ). You can go back a week, a month or a year by pressing (⌘ 1234), (⌘ 4GHI) and (⌘ 7PQRS) respectively. To reach the current day, press (⌘ C).

### Advanced Options

Selecting *Advanced* offers you the following options:

- **Find:** Search for appointments or tasks that contain a specific text. Enter the text you wish to search for and press *Ok*.
- **Send:** Send appointments/tasks via Bluetooth, the infrared port or picture message (► **47 Picture Message (MMS)**). Select from *Send day*, *Send week*, *Send month* and select a transfer method.



You can also send an individual appointment/task by selecting the appointment/task and *Send*.

- ▶ **Memory status:** Display how much memory is available for new appointments and tasks.
- ▶ **Delete all:** Delete all appointments and tasks in your calendar.

## Options

The following options are available:

- ▶ **View**
  - ▶ **Starting day:** Select a start day for the week.
  - ▶ **Week display:** Select 5-day week or 7-day week.
- ▶ **Profile switch**
  - ▶ **Off:** Switch profile off.
  - ▶ **Manual:** Remind you to switch profile when a meeting is about to start.
  - ▶ **Auto:** Switch profile automatically
- ▶ **Reminders**
  - ▶ **Always:** Set the alarm to ring even if the phone is switched off.

- ▶ **Never:** Set the alarm off.
- ▶ **If phone on:** Set the alarm to ring only when the phone is switched on.

## Notes

- ▶  Organizer ▶ Notes

Use your phone as a Notepad. You can add, edit, delete or send a note. (You can save up to 10 notes.)

### *Adding and viewing a note*

- 1 ▶  Organizer ▶ Notes or press **More** in standby mode and select **Post note**.
- 2 ▶ **New note** to add a new note or select a note you wish to display.
- 3 Enter the text and press **Ok**.



If the note is long and you cannot see all of it, press **More** and **Show note**.

To turn off the note in standby mode, press **More** and select **Hide note**.

### Exchanging notes

You can send and receive notes using Bluetooth, the infrared port or picture messaging.

#### *Sending a note*

- 1 ▶  Organizer ▶ Notes
- 2 Highlight a note.
- 3 ▶ More ▶ Send
- 4 Select a transfer method.

#### *Receiving a note*

- 1 ▶ More ▶ Turn on Bluetooth or  
▶ Turn on infrared in standby mode.
- 2 The message, **Add note?** appears. Press **Save** to save the note to your phone memory.

### Alarms

- ▶  Organizer ▶ Alarms

Select **Alarm** to set the alarm at a specific time, or **Recurrent alarm** to set it recurrently at a specific time on several days.

Assign a sound to **Alarm** ➔ **92 Alarm signal.**

### Timer

- ▶  Organizer ▶ Timer

To start and stop the timer at a certain time.

Enter the time you wish the timer to run for using the keypad (maximum 99:59:59) and press **Start**. Once the timer is set, you have the following options: **Cancel** and **New time**.



You will still hear the alarm even if the phone is set to **Silent** or switched off.

Press any key to turn the alarm/timer off.

The volume of the alarm/timer is determined by the ringer volume setting. If the ringer volume is off or the **Turn on silent** option is selected, the alarm/timer will ring at the minimum volume. The alarm/timer will still be heard even during a call.

When the alarm/timer is on,  appears in the display in standby mode.

## Stopwatch

►  Organizer ► Stopwatch



Once the counter reaches 23:59:59.9 the timer stops automatically.

The stopwatch is automatically turned off if you answer an incoming call or exit the stopwatch menu.



## Calculator

►  Organizer ► Calculator





The Calculator can perform addition (+), subtraction (-), multiplication (×), division (÷) and percentage (%) calculations.

- Use the Navigation key to go through the mathematical operations of ÷, ×, -, +, ., %, = in that order.
- Press  to select “.”.
- Press  to clear the entered value.
- Press  to exit the calculator.

## Using the calculator

- 1 ►  Organizer ► Calculator
- 2 Enter a number.
- 3 Select the mathematical function using the Navigation key and then enter another number.
- 4 Press Select or  to select “=” for a result.

In this example we are going to subtract 20% from 120.

   -   % =

## Code memo

►  Organizer ► Code memo

Code memo function offers the option to store all the different security codes, for example, the one for your credit card. You can save a maximum of 10 codes in the Code memo.

### Checkword and security

To confirm that you have entered the correct password for the code memo and to prevent unauthorised access to your codes, you must enter a checkword. When you enter your password to open the code memo, the checkword is displayed for a short time. If the password is correct, the correct codes appears. If you enter the incorrect password, the checkword and the codes that are displayed are also incorrect.

Factors strengthening the security of the Code memo functions are:

- You get no feedback about whether the password is correct, except for the checkword.
- All codes are encrypted in the mobile phone.
- When you access your codes, they are displayed for a limited time only.

### *To open code memo for the first time*

- 1 ▶  Organizer ▶ Code memo  
The message with instructions is displayed. Press Ok.
- 2 Enter a 4-digit password and press Ok.
- 3 Re-enter the new password to confirm.
- 4 Enter a checkword (maximum 15 characters) and press Ok.



The checkword can consist of both letters and number. To enter a number, press and hold the alphanumeric key.



*To add a new code*

- 1 ▶  Organizer ▶ Code memo
- 2 Enter your password and press Ok.
- 3 ▶ New code
- 4 Enter a name associated with the code, for example, the name of the credit card company and press Ok.
- 5 Enter the code and press Ok to confirm.

*To open code memo*

Follow steps 1-2 in ➡ **105 To add a new code**. Your entered checkword and your codes are displayed when the decryption process has finished.

*To change the password*

- 1 Follow steps 1-2 in ➡ **105 To add a new code** and press More.
- 2 ▶ Change password and enter your new password followed by Ok.
- 3 Re-enter the new password and press Ok.

- 4 Enter a checkword and press Ok.



If you forgot your password, enter any password to access the Code memo function. The checkword and codes that are displayed are incorrect. You must now reset the Code memo.

*To reset code memo*

- 1 Follow steps 1-2 in ➡ **105 To add a new code** and press More.
- 2 ▶ Reset  
The message Reset code memo? is displayed.
- 3 ▶ Yes  
The code memo is reset and all entries are cleared. The next time you select the Code memo function, you must start at ➡ **104 To open code memo for the first time**.

## Entertainment

*Playing games and downloading an application.*

### Entertainment

Your phone has several entertaining applications and games. You can play some of the games with another person, both using your phone, or you can play on two phones using Bluetooth wireless technology or infrared. You can also download games and applications directly to your phone. Help texts are available in some games and applications.

#### *Downloading applications*

- 1 ▶  Entertainment
- 2 ▶ Games & more ▶ New applications (for example, Sony Ericsson)
- 3 Follow instructions to download an application.
- 4 ▶ More to get more information about the game.



#### *Downloading a game*

- 1 ▶  Entertainment ▶ Other games  
▶ New game
- 2 Follow instructions to download a game.
- 3 ▶ More to get more information about the application.











Make sure the file sizes do not exceed the free memory in your phone.

#### *Playing games*

- 1 ▶  Entertainment ▶ Other games
- 2 Select the game you wish to play. (Press More to delete, read the game information, or view the memory status.)
- 3 ▶ Start
- 4 ▶ Help to read the help text or  to end the game.

## Movement

Use the Navigation key to move up, down, left or right and to select an item, or use the keys as follows:

 left up     up     right up  
 left     select/fire     right  
 left down     down     right down

# Appendix

## Troubleshooting

Problem	Possible Causes	Possible Remedies
Unable to switch on	Empty battery	Charge the battery ➡ <b>18 Charging the battery.</b>
	Defective battery	Replace the battery. Note that after several years reduction in battery capacity is normal.
The  icon appears	Weak signal	Move to an open space or closer to a window.
	Outside GSM coverage area	Check operator coverage map.
	SIM not valid	Call your service provider.
	Network access not allowed	Try manual network search ➡ <b>87 GSM Networks.</b>
Call not possible	Dialling error	Use full national area code. When abroad, use full country code.
	Restrict calls set	Check restrict call settings ➡ <b>61 Restrict calls.</b>
	Another SIM inserted	Check for new restrictions.

Problem	Possible Causes	Possible Remedies
Difficult to hear the other party	—	Adjust earpiece volume, and reduce noise around you ➡ <b>27 Adjusting the Ringer/Speaker volume.</b>
Phone loses network	Weak signal	Reconnection, or connection to another operator is automatic. Switching phone off and on may accelerate this.
SIM error	Damaged SIM card	Please contact your service provider.
SIM card not registered	Network does not recognise the SIM card	Please contact your service provider.
Not able to receive calls	Restrict calls set	Check restrict call settings ➡ <b>61 Restrict calls.</b>
	Divert set	Check call divert settings ➡ <b>60 Setting a Divert.</b>
Battery Charging indicator does not appear	Battery over-discharged	Charge the battery a full charging cycle (up to approximately 3 hours) for the indicator to appear.

Problem	Possible Causes	Possible Remedies
Unable to access any WAP sites	Not subscribed	Check with your network operator/service provider to confirm whether your subscription allows access to WAP services and whether it is possible to access WAP when roaming.
	Wrong access selected	Check that the default Access Profile is usable in the current network and that GPRS (operator dependent) is turned on in this profile.
Unable to access an E-mail account	Account already in use	Check that you are logged off of your E-mail account on your PC.

## Security

*PIN, PIN2, SIM card and Phone locks.*

### PIN (Personal Identification Number)

When the PIN is enabled, your phone prompts you to enter the PIN each time you switch on the phone. You can change your PIN to any 4-8 digit number at any time as long as the PIN option is enabled. To change the PIN ➔ **97 SIM lock**.

 For security purposes, if you enter the PIN incorrectly 3 times, your PIN will be blocked and you will have to enter the PUK (Personal Unblocking Key) to unblock it ➔ **112 Unblocking the SIM card**.

 If the PIN option is disabled, the risk of unauthorised use of your phone is greater. The disabling of the PIN control is SIM card dependent.

### PIN2

 PIN2 is a code provided by your network operator/service provider and is required for access to some features such as Fixed Numbers or Call Cost. These features are not supported by all networks.

### SIM card lock

The SIM card lock protects your subscription, but not your phone itself, from unauthorized use. If you change SIM cards, the phone still works with the new SIM card. Most SIM cards are locked at the time of purchase. If the SIM card lock is on, you have to enter a PIN every time you turn on your phone. If you enter your PIN incorrectly 3 times in a row the SIM card is locked. This is indicated by the message, **PIN blocked**. To unblock it you need to enter your PUK (Personal Unblocking Key). Your PIN and PUK are supplied by your operator. To edit your PIN/PIN 2 and turn the SIM card lock on/off ➔ **97 SIM lock**.

### *Unblocking the SIM card*

If you enter the PIN incorrectly 3 times in a row, the SIM card is blocked.















- 1 Enter the PUK (Personal Unblocking Key) and press Ok.
- 2 Enter the new PIN (4-8 digits) and press Ok.
- 3 Enter the new PIN again and press Ok.  
The SIM card is unblocked.













 If you enter the wrong PUK 10 times, your SIM card is blocked completely. In this case contact your network operator/service provider. In order to receive more information (SIM and PUK), please contact your network operator/service provider.































































## Icon glossary

*Icons which may appear in the display.*

Icon	Explanation	Icon	Explanation
	Desktop icon		Network signal (strong)
	Network signal (strong) & GPRS within range		Network signal (strong) & GPRS attached
	Premium charge zone		Battery status
	No incoming calls available		Active call
	Line 1, activated		Line 2, activated
	Call ended		Missed calls
	Incoming call barring		Unconditional divert

Icon	Explanation	Icon	Explanation
	Home network, within range		Preferred network, available
	Ciphering not supported		Personalised profile
	Network forbidden and not available		Alarm set
	Signals off, (expect alarm & timer)		Card lock or phone lock. Secure connection (WAP)
	Timer set		MMS notification
	SMS notification		E-mail notification
	Voicemail notification		

Icon	Explanation	Icon	Explanation	Icon	Explanation	Icon	Explanation
	WAP push notification		Fax notification		High priority (task/message)		Low priority (task/message)
	Cell information notification		A GPRS session, in progress		Answered call		Dialled number
	Infrared port, activated		Infrared communication, in progress		Home number (contact)		Work number (contact)
	Bluetooth, activated		Bluetooth communication, in progress		Mobile number (contact)		Fax number (contact)
	Bluetooth headset attached		Chat prompt		Other information		E-mail address (contact)
	Chat session, in progress		All day calendar (appointment)		Picture attached (contact)		SMS saved on the SIM card
	Reminder set (appointment)		Task completed		Magic word, activated		Voice message unread
					Message unread		Message read
					Only part of an unread E-mail/MMS saved		Only part of a read E-mail saved

Icon	Explanation	Icon	Explanation	Icon	Explanation	Icon	Explanation
	Unread message will be deleted the next time you connect to the server		Read message will be deleted the next time you connect to the server		MMS play		Picture not available
	Message saved (unsent items)		Message template		MMS pause		MMS stop
	Message sent		Message delivered		Business card attached (MMS)		Message option
	Message read by the recipient		Sent message expired/been rejected		Theme attached (MMS)		Event attached (MMS)
	Message damaged		E-mail with attachment		Recorded sound attached (MMS)		Melody attached (MMS)
	Upper & lower case		T9 text input		Picture size, large		Note attached (MMS)
	Lower case		Upper case		Save picture (camera)		Picture size, small

## Safe and Efficient Use

*Please read this information before using your mobile phone.*



### RECOMMENDATIONS

- Always treat your product with care and keep it in a clean and dust-free place.
- Do not expose your product to liquid or moisture or humidity.
- Do not expose your product to extreme high or low temperatures.
- Do not put your product in a microwave oven; this may cause damage to either the oven or the product.
- Do not expose your product to open flames or lit tobacco products.
- Do not drop, throw or try to bend your product.
- Do not close your phone with an object inserted between keypad and display; this may cause damage to your product.
- Do not paint your product.
- Do not use your product near medical equipment without requesting permission.



- Do not use your product when in, or around aircraft, or areas posted "turn off two-way radio".

- Do not use your product in an area where a potentially explosive atmosphere exists.



- Do not place your product or install wireless equipment in the area above your car's air bag.

- Do not touch the External Antenna Connector.

- Do not attempt to disassemble your product. Only Sony Ericsson authorised personnel should perform service.



- Do not direct the infrared ray at anyone's eye and make sure that it does not disturb any other infrared units.

- To avoid hearing impairment, accept the call before holding your product (or portable handsfree device) to your ear.

### ANTENNA

Only use an antenna that has been specifically designed by Sony Ericsson for your mobile phone. Use of unauthorised or modified antennas could damage your mobile phone and may violate regulations, causing loss of performance and

SAR levels above the recommended limits ➡ 117  
**RADIO FREQUENCY (RF) EXPOSURE AND SAR**

## EFFICIENT USE

Hold your mobile phone as you would any other phone. Do not cover the top of the phone when in use, as this affects call quality and may cause the phone to operate at a higher power level than needed, thus shortening talk and standby times.

While in data transfer, the mobile phone is not designed to be held next to the ear.

## RADIO FREQUENCY (RF) EXPOSURE AND SAR

Your mobile phone is a low-power radio transmitter and receiver. When it is turned on, it emits low levels of radio frequency energy (also known as radio waves or radio frequency fields).

Governments around the world have adopted comprehensive international safety guidelines, developed by scientific organizations, e.g. ICNIRP (International Commission on Non-ionizing Radiation Protection), through periodic and thorough evaluation of scientific studies. These guidelines establish permitted levels of radio wave exposure for the general population. All Sony Ericsson mobile phone models are designed to operate within these stringent levels.

The levels include a safety margin designed to assure the safety of all persons, regardless of age and health, and to account for any variations in measurements.

Specific Absorption Rate (SAR) is the unit of measurement for the amount of radio frequency energy absorbed by the body when using a mobile phone. The SAR value is determined at the highest certified power level in laboratory conditions, but the actual SAR level of the mobile phone while operating can be well below this value.

This is because the mobile phone is designed to use the minimum power required to reach the network. Therefore, the closer you are to a base station, the more likely it is that the actual SAR level will decrease.

Variations in SAR below the radio frequency exposure guidelines do not mean that there are variations in safety. While there may be differences in SAR levels among various mobile phones, all Sony Ericsson mobile phone models are designed to meet the relevant radio frequency exposure guidelines.

A separate leaflet with SAR information for this mobile phone model is included with the material that comes with this mobile phone. This information can also be found, together with more information on radio frequency exposure and SAR, on [www.SonyEricsson.com/](http://www.SonyEricsson.com/).

## DRIVING

Please check if local laws and regulations restrict the use of mobile phones while driving or require drivers to use handsfree solutions. We recommend that you use only Sony Ericsson handsfree solutions intended for use with your product. Please note that because of possible interference to electronic equipment, some vehicle manufacturers forbid the use of mobile phones in their vehicles unless a handsfree kit with an external antenna supports the installation. Please contact your vehicle manufacturer for the appropriate position of the external antenna on your vehicle.

Always give full attention to driving and pull off the road and park before making or answering a call if driving conditions so require.

## PERSONAL MEDICAL DEVICES

Mobile phones may affect the operation of cardiac pacemakers and other implanted equipment. Please avoid placing the mobile phone over the pacemaker, e.g. in your breast pocket. When using the mobile phone, place it at the ear opposite the pacemaker. If a minimum distance of 15 cm (6 inches) is kept between the mobile phone and the pacemaker, the risk of interference is limited. If you have any reason to suspect that interference is taking place, immediately turn off

your mobile phone. Contact your cardiologist for more information.

For other medical devices, please consult the manufacturer of the device.

## CHILDREN

DO NOT ALLOW CHILDREN TO PLAY WITH YOUR MOBILE PHONE OR ITS ACCESSORIES. THEY COULD HURT THEMSELVES OR OTHERS, OR COULD

ACCIDENTALLY DAMAGE THE MOBILE PHONE OR ACCESSORY. YOUR MOBILE PHONE OR ITS ACCESSORY MAY CONTAIN SMALL PARTS THAT COULD BE DETACHED AND CREATE A CHOKING HAZARD.



## DISPOSING OF THE PRODUCT

Your mobile phone should not be placed in municipal waste. Please check local regulations for disposal of electronic products.



## POWER SUPPLY

Connect the AC power adapter only to designated power sources as marked on the product. Make sure the cord is positioned so that it will not be subjected to damage or stress. To reduce risk of electric shock, unplug the unit from any power source before attempting to clean it. The AC power adapter must not be used outdoors or in damp areas. Never alter the cord or plug. If the plug will not fit into the outlet, have a proper outlet installed by a qualified electrician.

Limit the distance between the mains socket and the mobile phone when charging for easy accessibility. As an energy-saving measure, disconnect the charger from the main socket after charging.

## EMERGENCY CALLS

Mobile phones operate using radio signals, which cannot guarantee connection under all conditions. Therefore you should never rely solely upon any mobile phone for essential communications (e.g. medical emergencies).

Emergency calls may not be possible on all cellular networks or when certain network services and/or mobile phone features are in use. Check with your local service provider.

## BATTERY USE AND CARE

We recommend that you fully charge the battery before you use your mobile phone for the first time. The battery can only be charged in temperatures between +5 °C (41 °F) and +45 °C (+113 °F).

A new battery or one that has not been used for a long time could have reduced capacity the first few times it is used.

The talk and standby times depend on the actual transmission conditions when using the mobile phone. If the mobile phone is used near a base station, less power is required and talk and standby times are prolonged.

- Warning! May explode if disposed of in fire.
- Use only Sony Ericsson branded original batteries and chargers intended for use with your mobile phone. Other chargers may not charge sufficiently or may produce excessive heat. Using other batteries and chargers could be dangerous.
- Do not expose the battery to liquid.
- Do not let the metal contacts on the battery touch another metal object. This could short-circuit and damage the battery.
- Do not disassemble or modify the battery.

- Do not expose the battery to extreme temperatures, never above +60 °C (+140 °F). For maximum battery capacity, use the battery in room temperature.



- Turn off your mobile phone before removing the battery.

- Keep out of children's reach.

- Use the battery for the intended purpose only.



- Do not allow the battery to be put into the mouth. Battery electrolytes may be toxic if swallowed.

### DISPOSING OF THE BATTERY

Please check local regulations for disposal of batteries or call your local Sony Ericsson Customer Care Centre for information. The battery should never be placed in municipal waste. Use a battery disposal facility if available.



### Limited Warranty

Sony Ericsson Mobile Communications AB, S-221 88 Lund, Sweden, (Sony Ericsson), provides this Limited Warranty for your mobile phone and original accessory delivered with your mobile phone (hereinafter referred to as "Product").

Should your Product need warranty service, please return it to the dealer from whom it was purchased, or contact your local Sony Ericsson Customer Care Centre (national rates may apply) or visit [www.SonyEricsson.com](http://www.SonyEricsson.com) to get further information.

### OUR WARRANTY

Subject to the conditions of this Limited Warranty, Sony Ericsson warrants this Product to be free from defects in design, material and workmanship at the time of its original purchase by a consumer, and for a subsequent period of one (1) year.

### WHAT WE WILL DO

If, during the warranty period, this Product fails to operate under normal use and service, due to defects in design, materials or workmanship, Sony Ericsson authorised distributors or service partners, in the country/region

► **122 EUROPEAN UNION (EU)** where you purchased the Product, will, at their option, either repair or replace the Product in accordance with the terms and conditions stipulated herein.

Sony Ericsson and its service partners reserve the right to charge a handling fee if a returned Product is found not to be under warranty according to the conditions below.



Please note that your personal settings/downloads might be lost when the Product is repaired or replaced.

## CONDITIONS

- 1 The warranty is valid only if the original proof of purchase issued to the original purchaser by an, for this Product, Sony Ericsson authorised dealer, specifying the date of purchase and serial number\*, is presented with the Product to be repaired or replaced. Sony Ericsson reserves the right to refuse warranty service if this information has been removed or changed after the original purchase of the Product from the dealer.
- 2 If Sony Ericsson repairs or replaces the Product, the repaired or replaced Product shall be warranted for the remaining time of the original warranty period or for ninety (90) days from the date of repair, whichever is longer. Repair or replacement may involve the use of functionally equivalent reconditioned units. Replaced parts or components will become the property of Sony Ericsson.
- 3 This warranty does not cover any failure of the Product due to normal wear and tear, or due to misuse, including but not limited to use in other

\*In some countries/regions additional information is requested. If so, this is clearly shown on the valid proof of purchase.

than the normal and customary manner, in accordance with the Sony Ericsson instructions for use and maintenance of the Product. Nor does this warranty cover any failure of the Product due to accident, software or hardware modification or adjustment, acts of God or damage resulting from liquid.

- 4 Since the cellular system on which the Product is to operate is provided by a carrier independent from Sony Ericsson, Sony Ericsson will not be responsible for the operation, availability, coverage, services or range of that system.
- 5 This warranty does not cover Product failures caused by installations, modifications, or repair or opening of the Product performed by a non-Sony Ericsson authorised person.
- 6 The warranty does not cover Product failures which have been caused by use of accessories or other peripheral devices which are not Ericsson or Sony Ericsson branded original accessories intended for use with the Product.
- 7 Tampering with any of the seals on the Product will void the warranty.
- 8 **THERE ARE NO EXPRESS WARRANTIES, WHETHER WRITTEN OR ORAL, OTHER THAN THIS PRINTED LIMITED WARRANTY. ALL IMPLIED WARRANTIES, INCLUDING**

WITHOUT LIMITATION THE IMPLIED WARRANTIES OF MERCHANTABILITY OR FITNESS FOR A PARTICULAR PURPOSE, ARE LIMITED TO THE DURATION OF THIS LIMITED WARRANTY. IN NO EVENT SHALL SONY ERICSSON OR ITS LICENSORS BE LIABLE FOR INCIDENTAL OR CONSEQUENTIAL DAMAGES OF ANY NATURE WHATSOEVER, INCLUDING BUT NOT LIMITED TO LOST PROFITS OR COMMERCIAL LOSS, TO THE FULL EXTENT THOSE DAMAGES CAN BE DISCLAIMED BY LAW.

Some countries/states do not allow the exclusion or limitation of incidental or consequential damages, or limitation of the duration of implied warranties, so the preceding limitations or exclusions may not apply to you.

The warranty provided does not affect the consumer's statutory rights under applicable legislation in force, nor the consumer's rights against the dealer arising from their sales/purchase contract.

## EUROPEAN UNION (EU)

If you have purchased your Product in an EU country you can have your Product serviced, under the conditions set out above, within the warranty period in any EU country where an identical Product is sold by an authorised Sony Ericsson distributor. To find out if your Product is sold in the EU country you are in, please call the local Sony Ericsson Customer Care Centre. Please observe that certain services may not be possible elsewhere than in the country of original purchase, e.g. due to the fact that your Product may have an interior or exterior which is different from equivalent models sold in other EU countries. It may not be possible to repair SIM-locked Products.

## FCC Statement

This device complies with Part 15 of the FCC rules. Operation is subject to the following two conditions: (1) This device may not cause harmful interference, and (2) This device must accept any interference received, including interference that may cause undesired operation.



## Declaration of Conformity

We, **Sony Ericsson Mobile Communications AB** of

Nya vattentornet  
S-221 88 Lund, Sweden

declare under our sole responsibility that our product

Sony Ericsson type AAB-1021031-BV

and in combination with our accessories, to which this declaration relates is in conformity with the appropriate standards 3GPP TS 51.010-1, EN 300 328, EN 301 489-7, EN 301 489-17 and EN 60950, following the provisions of, Radio Equipment and Telecommunication Terminal Equipment Directive **99/5/EC** with requirements covering EMC Directive **89/336/EEC**, and Low Voltage Directive **73/23/EEC**.

Lund, August 2003

*Place & date of issue*

**CE0682**

A handwritten signature in black ink, appearing to read 'Hiroshi Yoshioka', written in a cursive style.

*Hiroshi Yoshioka, Head of Product Business Unit GSM/UMTS*

We fulfil the requirements of the R&TTE Directive (**99/5/EC**).

# Index

- A**
  - Alarm 92, 103
- B**
  - Battery 17, 120
    - Charging 18
    - Inserting 17
  - Bluetooth headset 26
  - Bluetooth wireless technology 74
- C**
  - Calculator 103
  - Calendar 99
  - Call costs 63
  - Call list 59
  - Call timer 63
  - Call Waiting 29
  - Calling cards 64
  - Camera 66
  - Chat, see Messaging
- C**
  - Ciphering 25
  - Clock 95
  - Code memo 104
  - Conference call 30
  - Contrast 94
- D**
  - Data communication 88
  - Declaration of Conformity 123
  - Display 11, 13, 93
  - Divert calls 59
  - DTMF 27
  - During a call 27
- E**
  - E-mail, see Messaging
  - Emergency calls 22
  - External display 13
- F**
  - Fixed dialling 42
- G**
  - Games 106
  - Groups 38
- H**
  - Headset 26, 30
- I**
  - Icons (display) 113
  - Infrared port 78
- K**
  - Key functions 12, 13
  - Key sound 93
- L**
  - Language (display) 94
  - Light 93

- Locks 97
  - Phone 97
  - SIM card 97, 111

## **M**

- Magic word 31
- Making Calls 21, 35
- Master reset 98
- Menu overview 15
- Messaging 43
  - Chat 56
  - E-mail 50
  - Picture Message 47
  - Text message 45
- Microphone off/on 27
- Minute minder 93
- Missed calls 59
- MMS, see Messaging: Picture Message
- My numbers 40
- My shortcuts 58

## **N**

- Network 19, 87
- Network specific function, see SAT
- Networks 87
- Notes 101

## **O**

- Online services 73

## **P**

- Personal ring signal 39
- Phone 25
- Phonebook 35
  - Saving Entries 35
  - Service numbers 41
- Pictures 69
- PIN 19, 111
- PIN2 111
- Profiles 94
- PUK 111

## **R**

- Reset
  - all 98
  - Master 98
  - profiles 94
- Restrict calls 61
- Ring signals 92
- Ring Volume 92
- Ringer Volume
  - Adjusting 27
- Roaming 20

## **S**

- SAT (SIM Application Toolkit) 74
- Screen saver 93
- Shortcuts 58
- Signal Strength 19

SIM card 16

- Inserting 16
- Lock 111
- Removing 16
- Unblocking 112

SMS, see Messaging: Text message

Sound recording 97

Speaker Volume

- Adjusting 27

Speed dialling 24

Stopwatch 103

Synchronization 86

## **T**

Text entry 32

- Standard text entry 33
- T9 text entry 33

Themes 71

Timer 103

## **V**

Voice control 31

- Voice answering 26
- Voice dialling 23
- Voice redialling 24

Voice dialling 23

Voice mail 50, 58

## **W**

Wallpaper 93

WAP 79



[www.SonyEricsson.com](http://www.SonyEricsson.com)



**Sony Ericsson**

Sony Ericsson Mobile Communications AB, SE-221 88 Lund, Sweden  
EN 3-255-627-12(1). Printed in France