

Mobile Telephone

Operating Instructions



CMD-J5

For easy reference, please record the following identification numbers for your phone and SIM Card. This information will assist you in customer inquiries to your retail dealer, manufacturer or Network Operator/Service Provider.
 In case of loss or theft of your phone and/or SIM Card, call your Network Operator/Service Provider immediately to prevent misuse.



My Mobile Phone Number: _____

Operator Customer Service Number: _____

My SIM Card Number:
 (Printed on your SIM Card) _____





My Phone's ID Number (IMEI):
 (Printed on the label underneath the battery pack) _____

Jog Dial

Operation	Function
Rotate 	Scrolls through menu options. Opens Phonebook in Standby Mode
Press (Click) 	Opens Menu in Standby Mode. Selects an option (highlighted) in the display.
Press and Hold 	Dials the Phone Number selected.

Quick Keys / Side Switch

-  **Voice Mail Key**
-  **Missed Calls**
-  **Side Switch**

- During standby mode, **slide up** to switch between: Silent mode , Single beep , Vibra Alert .
- **Slide side switch down** to lock/unlock the keypad .
- During a phone call, **slide up** to turn the loudspeaker on/off.
- During an incoming call, **slide switch up** to stop the ringer.
- During a game, **slide switch up** to stop/start the background melody.

Menu Overview

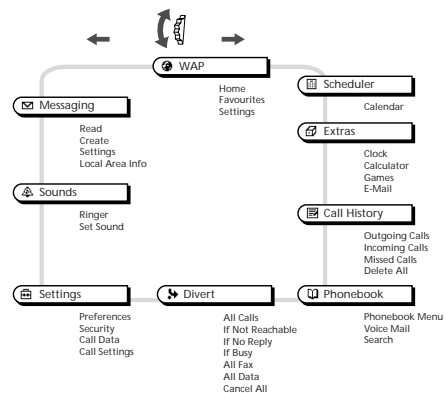

Making Calls

From Standby Mode

- 1 Dial the complete number you want to call (including area code).
- 2 Press and hold the Jog Dial (or ) to call the number displayed.

From the Phonebook

- 1 Rotate the Jog Dial in standby mode to open the Phonebook.
- 2 Rotate the Jog Dial to select a name.
- 3 Press and hold the Jog Dial (or ) to call the number.

Quick Reference

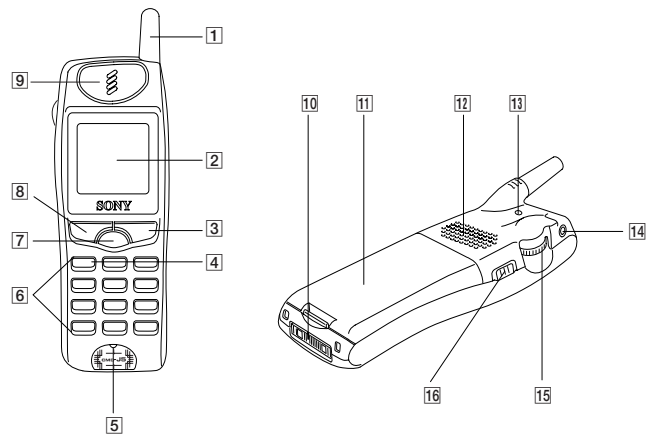

- | | |
|--|---|
| 1 Antenna | 10 External Connector (Charging and Accessories) |
| 2 Display | 11 Battery |
| 3 On/Off Key, Call End Key, Clear Key | 12 Loudspeaker |
| 4 Voice Mail Key | 13 External Antenna Connector |
| 5 Microphone | 14 Headset Connector |
| 6 Keypad (alphanumeric keys) | 15 Jog Dial |
| 7 Centre Key | 16 Side Switch |
| 8 Send Key | |
| 9 Ear piece | |

Safety Precautions

- Do not use your phone in an aircraft, hospitals or petrol stations.
- Note that in some countries using a cellular phone without a hands-free kit while driving is not allowed.
- Do not expose your phone to extreme conditions such as high humidity/rain, high temperatures, direct sunlight, caustic/harsh chemicals or dust.
- Do not allow children to play with your phone.
- Take special care in the disposal of your battery, using a special facility where available. Do not puncture, burn, or short circuit your battery.
- Limit the distance between the mains socket and the phone when charging for easy accessibility.
- Consult your physician or the manufacturer of personal medical devices (pacemakers, hearing aids, etc.) regarding any restrictions on the use of a mobile telephone.
- Use only Sony-approved CMD-J5 batteries and accessories with your phone.
- Do not put your mobile phone in a microwave oven; this may cause damage either to the oven or the phone.

Warning

- Unauthorised batteries, chargers, and accessories will invalidate any approvals and warranty given for your phone and may be dangerous.
- For use in the car, please connect your GSM mobile phone to an external antenna. The external antenna can be connected to your mobile phone via the appropriate accessory, e.g. Hands-free Kit. Please contact your car manufacturer concerning the appropriate position of the external antenna on your car.

Table of contents

<i>Welcome to Sony CMD-J5</i>	5
What's Included in Your Kit	5
Basic Features of Your Phone	5
<i>Getting Started</i>	10
Inserting the SIM Card	10
Inserting the Battery Pack	11
Charging the Battery Pack	11
Switching on Your Phone	13
Connecting to the Network	14
<i>Basic Operation</i>	15
Making Calls (Saving Phonebook Entries)	15
Answering/Ending Calls	16
During a call	17
<i>Entering Text</i>	20
Standard Text Entry	20
T9 Text Entry	22
<i>Using the Phonebook</i>	23
Phonebook Organisation	23
Saving Phonebook Entries from Standby Mode	23
Making Calls from the Phonebook	23
Phonebook Menu	24
Voicemail	27
Search	27
Editing the Phonebook	28
<i>Menu Operations</i>	30
Messaging	30
Sounds	35
Settings	37
Divert	45
Call History	47
Extras	48
Scheduler	54
WAP	56

Table of contents

<i>Appendix</i>	59
Troubleshooting	59
Unlocking the SIM Card	61
Technical Specifications	62
<i>Index</i>	64

Welcome to Sony CMD-J5

What's Included in Your Kit

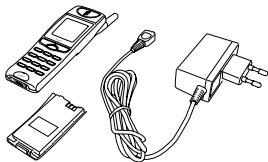

The kit should include one mobile phone, one Li-Ion standard battery, one charger and this manual. If one of these parts is missing, please contact your retail dealer immediately.



Basic Features of Your Phone

The Jog Dial

The Jog Dial provides fast and easy menu navigation with only one hand.

Operation		Function
Rotate		Scrolls through menu options. Opens Phonebook in Standby Mode.
Press (Click)		Opens Menu in Standby Mode. Selects an option (highlighted) in the display.
Press and Hold		Dials the Phone Number selected.



The Centre Key



- Press the Centre Key in standby mode to access the WAP mode if WAP settings are configured.
- During a call, press the Centre Key to access the Call Menu.
- Press and hold the Centre Key to access network-specific functions. (This feature is dependant on your network operator and may not be supported by some networks. Contact your Network Operator/Service Provider for details.)

The Voicemail Key

























- Press and hold  to access your Voicemail (see also page 27)

The Side Switch

- In standby mode, slide the switch up to activate/deactivate the manner modes.
- Afterwards, it is possible *to switch among the manner mode functions*. All manner mode icons appear in the display; rotate the Jog Dial to select one:
 - Silent Mode : turns the ringer and all tones to silent mode.
 - Ringer to Single beep : ringer is restricted to a discrete single beep.
 - Vibra Alert : Vibra Alert without the ringer.
- For your convenience, sliding the side switch up in standby mode will toggle between the two last settings.

- In standby mode, slide the switch down to lock/unlock your keypad (including Jog Dial). It is still possible to make emergency calls (112) as well as answer/reject an incoming call (by pressing /) when the keypad is locked. After the call ends, the keypad will lock again automatically.
- During a call, turn the loudspeaker on by sliding the switch up once. Turn the loudspeaker off by sliding the switch up again.
- During an incoming call, stop the ringer by sliding the side switch up.
- During a game, stop/start the background sound by sliding the side switch up.

Icon Glossary

Icon	Explanation
	Network not available
	Network signal strength (strong)
	Battery strength
	SMS (Envelope Icon)
	Voicemail
	Keypad locked
	Alarm
	Silent Mode
	Vibra Alert
	Single Beep
	Ringer off
	Missed calls
	Incoming call barring
	Outgoing call barring
	Incoming + Outgoing call barring
	Conditional Divert
	Unconditional Divert
	Active call
	Call hold
	Mute Microphone
	Headset connected
	Handsfree kit connected (auto answer on)
	Loudspeaker on
	Conversation Privacy (ciphering) not supported

Menu Overview

Press the Jog Dial from standby mode to access the main menu:

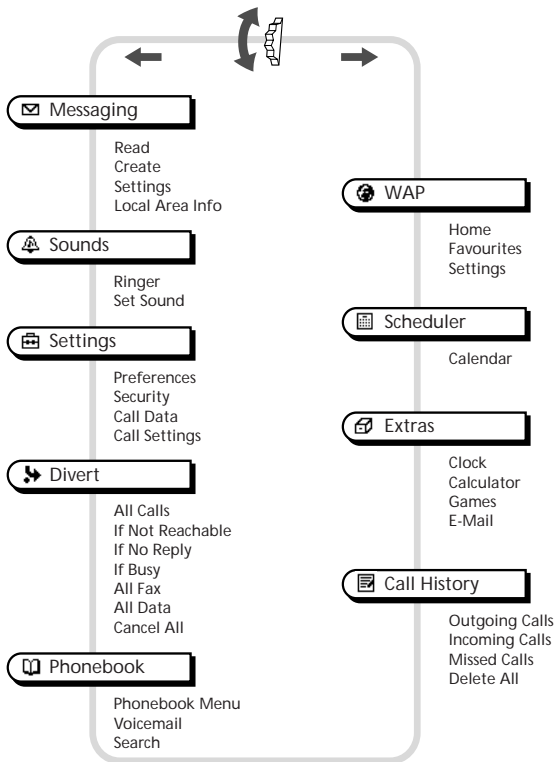

Getting Started

Inserting the SIM Card

Your SIM card contains a computer chip with your service details and phone number. Like a credit card, it should be kept securely and handled carefully. Do not bend, scratch or expose to moisture. Avoid static electricity.

Important

To avoid corrupting the memory of your SIM card, always switch off your phone before removing or inserting your SIM card.

- 1 Remove the battery pack.

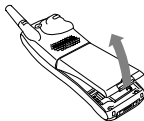

- 2 Slide the SIM card holder to the right to unlock and lift up the tray. Slide the SIM card into the tray (the gold contacts should be facing down and the angled corner positioned to the lower left).

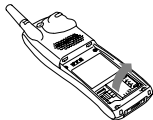

- 3 Close the tray with the SIM card inserted and slide the SIM card holder to the left to lock.

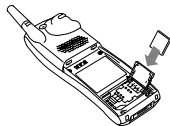

- 4 Replace the battery pack.

To remove the SIM card

Follow steps 1 to 4 above removing the SIM card from the tray in step 3.

Inserting the Battery Pack

- 1 Unwrap the battery pack.
- 2 Press the battery pack firmly into place and check that it snaps closed.

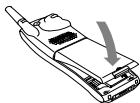

To remove the battery pack

First power off and wait until the display goes blank. Press the battery release hook up and remove the battery.

Important

If you insert a new battery, please reset the clock.

Charging the Battery Pack

As supplied, your battery pack will not be fully charged.

- 1 Plug the charger into a mains socket
- 2 Plug the charger into the bottom (jack) of the phone.

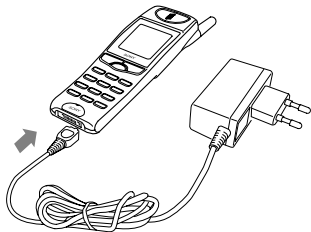

Removing the charger from the phone:

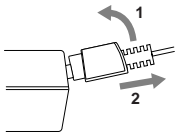

Notes

-  The status bar in the battery icon on the display indicates the charging status.
- Charging (0°C-45°C) is complete when the battery icon indicates all bars and is no longer blinking.
- Full charging can take up to approx. 3 hours, but may vary depending on certain conditions, (e.g. if your phone is switched on or temperature is outside the operating range.)
- When your battery pack is completely empty, it can take some time until the battery icon appears when charging.
- As an energy-saving measure, disconnect the charger from the mains socket and from the phone after charging.

Important

- Use only the Sony-specified CMD-J5 battery pack and charger.

Usage time

When your battery pack is nearly empty, the battery icon in the display flashes and there is a beep indicating that only approximately 1 minute of talk time is left.

Switching on Your Phone

To switch on/off your phone, press and hold .

Entering PIN (Personal Identification Number)

Enter your PIN using the number keys (the PIN appears in code as ****) and press the Jog Dial (or ) to confirm your entry.



If you do not enter a PIN code, your phone will automatically switch off after a few minutes. It is possible but not recommended to disable the PIN code prompt (see page 39).

Connecting to the Network

After successfully entering your PIN code, your phone searches for an available GSM network. The network search is automatic and may take a few seconds.

You are ready to make and receive calls when the network operator's name and the signal strength icon appears on the display.



The following indicates the strength of the received network signal. If the signal is very weak, there is a risk of losing service.



Strong signal ↔ Weak signal ↔ No service

If you cannot obtain service

If you cannot obtain network service the reception strength may be too weak. Move to a higher elevation, a window or an open space and make sure that there is nothing obstructing the antenna.





Roaming ▲

If you are out of range of your “Home” network operator, especially when abroad, another network operator may be selected automatically, subject to signal strength and roaming agreements between network operators. Contact your network operator/service provider for details.

Basic Operation

Making Calls (Saving Phonebook Entries)

Dialling a Number

- 1 Dial the complete number of the party you want to call (including the area code even when dialling locally). In case of International Calls, press and hold  until “+” appears. Then enter the country code, followed by the area code and the number. 
- 2 Press  to correct any errors. Press and hold  to clear the entire number.
- 3 Press and hold the Jog Dial (or press ) to call the number displayed or
- 4 Select save and press the Jog Dial to save the number to the Phonebook.

Notes

If the *Auto Redial* option is on (see page 44) and the number you have called is engaged, your phone automatically displays the *Auto Redial* option.

Choosing a Phonebook entry

- 1 Rotate the Jog Dial in standby mode to open the Phonebook.
- 2 Use the Jog Dial to display the ABC sort list. (If there are several numbers stored for one person's name, select one of them)
- 3 Press and hold the Jog Dial (or press ) to call the number displayed.

Notes



To search the Phonebook, press an alphanumeric key on the keypad to advance to that letter in the Phonebook. (E.g. to advance to entries beginning with “M”, press .

Answering/Ending Calls

Press the Jog Dial (or ) to accept an incoming call.

Notes

If you do not wish to answer the call, press  while the phone is ringing. The call will then be rejected (the caller will hear a busy tone or will be diverted if a divert has been set).

If a call is not answered,  appears on the top line of the display. Press  in standby mode or select the Call History from the Main Menu for information about the missed call. Press  to remove the icon.

Press  to end a phone call.

Notes

In very rare cases, ciphering does not work in some networks, meaning that third parties can listen to your phone call. In this case,  appears on the display.

When the Headset is connected to your phone, answer a call by pressing the Headset button (beep). Press and hold the Headset button to end the call (2x beep).



Connect/disconnect the headset **only** when the phone is switched off or in stand-by mode (operator's name appears on the display).

During a call

Adjusting the Ringer/Speaker Volume

- During an incoming call, rotate the Jog Dial to adjust the ringer volume.
- During a call, rotate the Jog Dial to adjust the speaker volume. (Rotate up = increase volume / Rotate down = decrease volume)
- During an incoming call, stop the ringer by sliding the side switch up.

Important

- Use your phone as a Notepad by entering a phone number during a call. Enter a number and press the Centre Key. When ending the call, the number entered will reappear on the display. Use the Jog Dial to save the number in the Phonebook or to call the number.
- When sending DTMF tones, press and hold  then press  again to end the call.

Call Menu

Press the Centre Key during a call for the following options:

Call Hold

Use Call Hold to manage two calls at the same time. Check with your Network Operator/Service Provider for details about this service.

One active call

- 1 Press the Centre Key and select *Call Hold*.
- 2 Press the Jog Dial to confirm.
- 3 Press the Jog Dial again to access the Phonebook to retrieve a number (or use the keypad to enter a number).
- 4 Press and hold the Jog Dial or  to make a call.

Important

By pressing  or using the Notepad to make a second call, you can put a call on hold automatically.

End All Calls

Choose End all Calls or press  to end multiple calls.

Send DTMF

Choose this option for sending DTMF tones, e.g. when using Voicemail or other services.

Mic Off/Mic On

Choose the Mic Off/Mic On option to mute and unmute the microphone.

Loudspeaker

Turn the loudspeaker on/off. For best results when using the loudspeaker, place the phone on a flat surface approx. 0.5 m distance from you.

Main Menu

Return to the Main Menu.

One active call (and/or one call on hold) and one call waiting

When your phone alerts you (beep) that a call is waiting, there are several options available:

- 1 The display automatically offers you call waiting options.
- 2 Select *Swap* to put the active call on hold and connect the waiting call (in case of one active call and one waiting call)

or

select *Busy* to indicate to the calling party that your line is engaged.

or

select *Replace* to end the active call and retrieve the call waiting.

When the Headset is connected to your phone, answer a waiting call by pressing the Headset button (beep). In case of one active call and one call on hold, alternate between the active call and the call on hold by pressing the Headset button (beep).

Entering Text

You have the possibility to enter characters: *Standard Text Entry using the keypad*, *Standard Text Entry using the Jog Dial*, and *Text Entry using the T9 fast text entry method*.

Standard Text Entry

Using the keypad:

Press the corresponding alphanumeric key multiple times until the desired character appears.

Using the Jog Dial:





Press a key once and then rotate the Jog Dial until the desired character appears. Press the Jog Dial or wait for a moment to confirm.



Example: To enter "s" when creating a message:

- 1 Proceed as in *Create* (see page 31), then
- 2 Press . A character or number appears.
- 3 Rotate the Jog Dial to "s".
- 4 Press the Jog Dial (or wait) to confirm.

Important









- Press  to shift among:

	lower case letters permanently
	upper case letter and then revert back to lower case
	upper case letters permanently
	numbers

- Press  to clear the character or number just before the cursor. To clear the entire text, press and hold .



T9 Text Entry

Sample entry with T9 Text Entry:

- 1 Proceed as in *Create* (see page 31), then
- 2 In step 3, press and hold  to switch to T9 mode if  does not appear (or press the Centre Key and select T9).
- 3 Press  to shift to .
- 4 To type the word "Sony", press each of the following keys in order: , , , .
- 5 At the end of the word, check the preview bar for the possibilities found for the key combination you typed.
- 6 Rotate the Jog Dial to select "Sony". If your desired word is first on the list, just press the Jog Dial to select it.



Important

- If the word you intended to type does not appear in the list, press and hold  to switch to multi-tap mode and type the word using the standard text entry method (see page 20). When finished, press and hold  to return to T9 mode. This new word will automatically be added to the T9 memory and will appear in T9 mode next time.
- For "Smart Punctuation", just press  where you would add a fullstop, hyphen or apostrophe. T9 will automatically insert the most likely punctuation.

Using the Phonebook

Phonebook Organisation

Your Phonebook is organised in the following sections:

- Phonebook Menu
- Voicemail (if it is set)
- Search
- Customised Phonebook of priority entries (entries 1-9)
- Alphabetically-ordered Phonebook (sorted in alphabetical order)

Saving Phonebook Entries from Standby Mode

See page 15 Basic Operation – Making Calls (Saving Phonebook Entries) and page 25 Creating Entries in the Phonebook.

Making Calls from the Phonebook

See page 15 Basic Operation – Making Calls (Saving Phonebook Entries).

Phonebook Menu

Own Number

The first entry in the *Phonebook Menu* is a place holder for your own numbers, where you can make one or more entries to store your own mobile number, etc. Depending on your SIM card, you can save multiple own number entries (including 3 numbers in the phone).

Display Own Number

- 1 Rotate the Jog Dial in standby mode to open the Phonebook.
- 2 Select *Phonebook Menu* and press the Jog Dial.
- 3 Use the Jog Dial to select *Own Number*.
- 4 Rotate the Jog Dial to select the name of the own number.
- 5 Press the Jog Dial and then choose *View* to display the number (Press  to exit).

Enter Own Number

To save an own number entry follow steps 1-3 and then select an empty memory space using the Jog Dial. Press the Jog Dial and enter the number at the prompt.

Call, Edit, Delete, Copy Own Number

See page 28 “Editing the Phonebook”.

Creating Entries

- 1 Rotate the Jog Dial in standby mode to open the Phonebook.
- 2 Select *Phonebook Menu* and press the Jog Dial.
- 3 Select *New Entry* and press the Jog Dial.
- 4 Select *SIM Card* to save the entry to the SIM card memory or *Phone* to save to the phone memory.
- 5 Rotate the Jog Dial to select the *Number Type* Icon and press the Jog Dial.
- 6 Enter the phone number. Press Jog Dial to confirm.
- 7 Enter a new name. Press the Jog Dial to confirm.

Notes

- When saving the Phonebook entries to the SIM card, the number of memory spaces depends on your SIM card.
- When saving the Phonebook entries to the Phone memory, you can make up to 500 entries (up to 20 characters for each name and up to 40 digits for each number.)
- To assign a group, select an entry from the Phonebook and select *No Group*. Use the Jog Dial to scroll and then select a group.

Service Numbers

This section of the Phonebook may contain Service Dialling Numbers (SIM card dependant). Service Dialling Numbers cannot be edited.

FDN Phonebook

This section may contain Fixed Dialling Numbers (SIM card dependant). To add an entry to the Fixed numbers rotate the Jog Dial down to *New Entry* in the *FDN Phonebook* and proceed as in Creating Entries in the Phonebook. You can call, edit, delete and copy the *FDN Phonebook* (see “Editing the Phonebook”). You need the PIN2 code to edit, delete and copy.

Notes

- The *FDN Phonebook* and *Service Numbers* are SIM card dependant.
- The *Service Numbers* cannot be modified.
- Contact your Network Operator/Service Provider for details.

Vicemail

Press and hold  for quick access to your *Vicemail*.
Contact your Network Operator for details.

Set up your Vicemail

- 1 Rotate the Jog Dial in standby mode to open the Phonebook.
- 2 Rotate the Jog Dial to select *Vicemail* and press the Jog Dial.
- 3 Enter the number at the prompt.
- 4 Press the Jog Dial to confirm your entry.



- After you have set up your Voice Mail, any editing of the number can be made via the Phonebook (see also Editing the Phonebook).
- The Voicemail icon () or the envelope icon (depending on the network) appears in the display to inform you when you have received new voice messages. Contact your Network Operator/Service Provider for details.

Search

- Use *Search* in the *Phonebook Menu* to search for a Phonebook entry.
- It is possible to search by *Name* or by *Group*.

Editing the Phonebook

Use this option for calling, editing, deleting or copying phonebook entries. The editing of entries is possible by Name, Number or by Note.

Editing a name/number

- 1 Rotate the Jog Dial in standby mode to open the Phonebook.
- 2 Rotate the Jog Dial to select the name/number you want to edit and press the Jog Dial.
- 3 Press the Jog Dial for a menu of editing options:
 - Name editing options:
 - Select *View* to see the complete name.
 - Select *Edit Name* to change the name.
 - Select *Delete Entry* to erase the name from the Phonebook.
 - Select *Copy Entry* to copy the entry from one memory location to another.
 - Number editing options:
 - Select *Call* to call the number.
 - Select *View* to display the number.
 - Select *Edit Type* to change the type of number (e. g. Mobile, Fax, etc.).
 - Select *Edit Number* to change the number.
 - Select *Delete* to erase the number from the Phonebook.
 - Select *Copy* to copy the number from one memory location to another.
- 4 Press the Jog Dial to confirm the selection.

Editing Note

The *Note* is like a memo pad for additional information e.g. e-mail addresses or postal addresses in the Phonebook.

- 1 Follow steps 1-3 in “Editing a Name/Number”.
- 2 Select the Note entry you want to edit.
- 3 Press the Jog Dial for a menu of editing options.
 - Select *View* to view the content.
 - Select *Edit Icon* to change the icon.
 - Select *Edit Text* to change the content.
 - Select *Delete* to delete the content from the Phonebook.
 - Select *Copy* to copy the entry from one memory location to another.
- 4 Press the Jog Dial to confirm your selection.

Menu Operations

- | option on
- || option off

Messaging

This feature offers correspondence options to read, write and send short messages (SMS).



Read Message

When a new message arrives, you will hear a beep which sounds different from the single beep of the ringer and see in standby mode.

- 1 Use the Jog Dial to select *Read* from the *Messaging* menu and then *Inbox* for received messages. (Select *Outbox* to read sent messages.)
- 2 Scroll through the list of messages to select the message you want to read and press the Jog Dial to confirm. The message appears on the display.
- 3 Press the Jog Dial for options to *Delete*, *Reply*, *Save*, *Forward* or *Call Back* the number in the text.

Notes

- The capacity for storing incoming and outgoing messages depends on your SIM card.
- The message memory is full when blinks in the display.
- *Memory Full* appears if you try to save a message when the SIM memory is already full. Delete old messages in order to free memory space for new messages.
- Select *Delete All* to clear all messages.

Create

Choose *Create* to create and send a message.

- 1 Use the Jog Dial to select *Create* from the Messaging menu.
- 2 Choose *Text Only* or *Text, Attach* (write the text with attachment)
- 3 Create your message.

Text Only: Enter the message text.

Text, Attach: Add an attachment and enter the message text.

- 4 When creating your message, press the Centre Key for the following options:

T9 On/Off

Change Language

Phonebook

Template

Last Message

- 5 Press the Jog Dial to confirm. Select *Enter Number* or choose one of the names from the Phonebook.
Before sending, you are given the following options:

Send



Save

Cancel

Notes

If you are interrupted (e.g. incoming call) while creating a message, select *Last Message* to retrieve the message and complete it continuing from step 4 above.

SMS list icons indicate the properties of the message

	Received message (unread)
	Received message (read)

To Delete a Message

- 1 Follow steps 1-3 in Read Message and select *Delete*.
- 2 After selecting the message you want to delete, select *Yes*.

To Reply or Edit a Message

- 1 Follow steps 1-3 in Read Message and select *Reply*.
- 2 Choose *Text only* or *Text, Attach* (reply the text with attachment)
- 3 Edit the message and press the Jog Dial.
- 4 Select *Send* (or *Save, Settings, Cancel*) and press the Jog Dial to confirm your selection.

To Save a Message

Follow steps 1-3 in Read Message and select *Save*.

To Forward a Message

Follow steps 1-3 in Read Message and select *Forward*.

To Call Back the Sender of a Message or a Number in the Message Text

- 1 Follow steps 1-3 in Read Message and select *Call Back*.
- 2 Select the number you want to call back from the number(s) appearing in the message, then call the number.

Settings

Settings allows you to customise outgoing messages including the format, confirmation report, etc. Contact your Network Operator/Service Provider for details. Select Settings from the Messages menu, then select a Settings option using the Jog Dial.

Memory Class

You have the following options:

- *SIM* to save the message on the recipient's SIM card.
- *Phone* to save the message in the recipient's phone.
- *Screen* to display the message directly on the recipient's display (without saving to the SIM or to the phone). It is not recommended to send confidential messages using the Screen option.

Validity Period

Specify how long messages are stored in the service center by selecting: *1 hour, 6 hours, 24 hours, 1 week, 4 weeks*. The default validity period is 1 Week.

Reply Cost

Select *On* if you would like to pay for the recipient to respond to your message.

Result Report

Select On if you would like to receive confirmation that your messages are transmitted to the recipient successfully.

Message Format

Specify how your message is transmitted: SMS, e-mail, Fax, Telex, Voice (if available). The default setting is SMS.

Service Centre

Before you can send short messages, register your Service Centre number via the Service Centre option in the Messaging menu.

Local Area Info

Receive Cell broadcast messages or general messages like weather reports, traffic reports, etc. broadcast to a group of phones in a certain area. Some of these options may be network dependant. Contact your Network Operator/Service Provider for details.

- 1 Select *Local Area Info* from the *Messaging* menu.
- 2 Select one of the following options:
 - Received* to view cell broadcast messages.
 - Select Channel* to add or delete a broadcast channel.
 - Receive?* to choose whether or not to receive Cell broadcast messages.
 - Tone* to enable/disable a tone to indicate that you have received a cell broadcast message.
- 3 Press the Jog Dial to confirm your selection.

Sounds

Choose *Sounds* to access any sound-related option in your CMD-J5, for example ringer melodies, ringer volume, enable/disable sounds, and record your own ringer melodies or other sounds.

Ringer

Ringer Volume

Choose from four ringer volume levels or turn the ringer off.

Important

-  appears in standby mode to remind you when the ringer is turned off.
- Quickly turn the ringer on/off, or to single beep by using the side switch (see page 6). Adjust the ringer volume during an incoming call (while ringing) by rotating the Jog Dial.

Ringer Type

Select from among different ringer melodies.

Group Ringer

Assign a ringer sound to the different groups saved in your Phonebook. It is not possible to assign a ringer melody to a single name/number.

My Ringers

It is possible to record own ringer sounds using the phone's microphone. Choose the respective Icons to Record (●), Stop (■), Play (▶), Save (✓) or Delete (🗑) a ringer melody.



Set Sound

Select *Sounds* from the main menu and choose *Set Sound* to access the following sound options:

Event Sounds

Assign a sound to be heard at the following actions of your CMD-J5: *Receive SMS*, *Alarm*, *Scheduler Alarm*, *Power Up* and *Power Down*. It is possible to record sounds using the phone's microphone.

Key Click

Choose *Key Click* to turn the key click sound on/off.
Select *DTMF* to turn the DTMF tones on/off. DTMF tones are designed to respond to menu prompts when pressing a key.
Choose *Silent* to turn off the Key click sound on/off.

Error Tone

Select *Error Tone* to assign a sound to the error tone. Choose from a default error tone or recorded sounds (only if you have sounds stored under *My Sounds*).

My Sounds

Select *My Sounds* to record own sounds using the phone's microphone. Choose the respective icons to Record (●), Stop (■), Play (▶), Save (✓) or Delete (🗑) a sound.

Settings

Preferences

Choose Preferences to personalise your phone according to your preferences, e.g. which language, backlight on/off, etc.

When you receive your phone, it has the following default settings:

Item	Default	Page
Language	SIM dependent*	37
Greeting	Off	37
Wallpaper	**	38
Backlight	On	38
LCD Contrast	0	38
Select Network	Auto	38
Preferred List	SIM dependent	38
Memory Info	–	38
Factory Reset	–	38

* default language depends on language of the Network Operator.

** default wallpaper depends on Network Operator/Service Provider.

Language

Select Language from the Preferences Menu and then use the Jog Dial to select the appropriate language.

Notes

- As a short cut, you can also select the language by pressing *#00(country code)#.
- Select your default language by pressing *#0000#.

Greeting

The *Greeting* menu allows you to turn on/off or to edit the greeting message which appears when you turn your phone on.

Wallpaper

Select pictures as a wallpaper to appear on the display in standby mode.

Backlight

Choose Backlight to turn the illumination of the keypad and display on/off. Switch the Backlight off and your phone's battery charge will last longer.

LCD Contrast

To adjust the contrast of your display.

Select Network

This feature gives you the option to select a network automatically when you turn on your phone, or manually from a list of available networks.

Preferred List

Choose *Preferred List* to edit the automatic network selection priority list. This feature is helpful e.g. to prioritise roaming partners.

Add Network to add a network operator to the list.

Move to adjust the order in which the names appear in the list.

Delete to remove a network operator from the list.

Memory Info

To display how much memory is available for *SIM*, *Phone* and the *Note* area.

Factory Reset

To perform a master reset of all of your phone's settings back to the factory settings except Phonebook, Schedule and Network/SIM card based settings. This will automatically restart your phone.

Security

The *Security* options allow you to control who uses your phone as well as their calling privileges. However, emergency calls (SOS) are always possible regardless of the restrictions/codes you set.

PIN Code

Select PIN code to enable/disable or change the PIN code. When the PIN code is enabled, your phone prompts you to enter the PIN code each time you turn on the phone. You can change your PIN code to any 4-8 digit number. Your PIN code can only be changed if the PIN control is switched on.

Important

- After entering the PIN code incorrectly three times, your PIN is blocked. Enter the PUK (Personal Unblocking Key) to unblock your PIN.
- After entering the PUK code incorrectly ten times, your SIM card is completely blocked and can only be unblocked by your Network Operator/Service Provider. For more details contact your Network Operator /Service Provider.
- If the PIN code is disabled, the risk of unauthorised use of your phone is greater. The disabling of the PIN control is SIM card dependant. Contact your Network Operator/Service Provider for details.

PIN2 Code

PIN2 is a code provided by your Network Operator/Service Provider and is required for access to some features such as FDN Phonebook or Call Cost. These features are not supported by all networks. Contact your Network Operator/Service Provider for details.

Call Barring

Limit calls made from your phone which can be useful e.g. if you lend your phone to someone else but do not want them to make international calls. The restrictions in the *Call Barring* menu require the barring password. Contact your Network Operator/Service Provider for details.

All Outgoing

Restrict all outgoing calls except emergency calls (112, etc.).

International

Restrict all international calls.

Int. Ex. Home

Restrict all outgoing international calls except those to your home country.

All Incoming

Restrict all incoming calls.

If Abroad

Restrict all incoming calls when you are outside of coverage from your registered Network Operator (e.g. when abroad).

Cancel All

Cancel all settings of the call barring service.

Barring PWD

Some of the restrictions in the Security menu are controlled in the network e.g. Call Barring. Your Network Operator/Service Provider provides a (Network) password if you register for one or more of these network call restrictions (Call barring).

Changing the Barring Password

Select *Barring PWD* from the *Security* menu. Use the keypad to enter the old password and then enter your new password (4-8 digits). Enter the new password again and press the Jog Dial.

Notes

If the message *Invalid* appears, the old password you entered was incorrect. If you have difficulties, contact your Network Operator/Service Provider.

Security Code

The *Security Code* allows you to set a password to control access to your browser and E-mail. The default Security Code is: 0000.

Call Data

Track or control how long you are on the phone and the cost of calls made. So that Call costs can be used as a security measure e.g. when you lend your phone to someone, you must use your PIN2 as a security code when you set or change options. Contact your Network Operator/Service Provider for details.

Call Time

Check the length of your last call and total calls (incoming and outgoing). Rotate the Jog Dial to select which call time you want to check.

Call Cost

Check the cost of your last call, total calls and remaining credit. Rotate the Jog Dial to select the cost you want to check.

Reset Call Time

Use the Jog Dial to reset the Call time.

Call Cost Setting

Call Cost Setting offers a choice of three options:

- **Charge Rate**
Select *Charge Rate* to set the currency and price per unit which will be used to calculate the call cost.
Enter your PIN2 code at the prompt. Enter a currency and the price per unit (to enter a decimal point, press (#[Ⓢ]) or (*[Ⓢ])).
- **Charge Limit**
Select *Charge Limit* to set a unit figure at which your phone will not allow any more calls to be made. (If *Unit* in the *Charge Rate* menu (see above) was selected, enter the Unit value. In case of *Currency*, enter the Currency value.
Then enter your PIN2 code at the prompt, then set the charge limit.
- **Reset Call Cost**
Select *Reset Call Cost*, enter your PIN2 code and then reset the call cost.

Notes

In order to be able to make phone calls again, reset the *Call Cost* counter or enter a higher *Charge Limit*.

Call Settings

Some of the following features may not be supported by some network. Contact your Network Operator/Service Operator for details.

Caller ID

Choose whether or not you want the party you are calling to see your telephone number. Select *Caller ID* from the *Call Settings* menu. Use the Jog Dial to select *On*, *Off* or *Default* (network default).

Select Line

Some Network Operators offer the possibility to select between two separate phone lines on your SIM card. This is useful e.g. for separating business and private call costs.

To make a line selection in standby mode, press and hold (#*) and use the Jog Dial to make your selection. 1 or 2 will appear so that you know which line is active. It is also possible to make the line selection using the *Call Settings* menu option.

Some menu items may not appear in your phone in some networks unless you specifically subscribe for them. The following settings (e.g. *Divert*, *Security*, *Ringer Tone*, *Call Waiting* and *Voicemail*) will apply to the currently selected line. Some items such as your own number entry and voicemail entry may not be edited. All calls made will be billed to the currently selected line. The *Call Time* and *Call Cost* settings however, will always show the total time or cost of both lines.

Call Waiting

If activated, your phone will alert you (beep) that a call is waiting so that you don't miss any calls. Select *Call Waiting* and use the Jog Dial to select *Activate*, *Cancel* or *Check Status*.

Any Key Answer

Answer a call by pressing any key on the keypad.

Select *Any Key Answer* and use the Jog Dial to select *On* or *Off*.

1 Minute Beep

Turn the *1 Minute Beep* on (off) to be (not be) reminded by a beep in 1 minute intervals of the time you are on the phone.

Auto Redial

Automatic redial of an engaged line until it is no longer busy. Select On/Off to activate/deactivate this function. An incoming call will interrupt the *Auto Redial* feature.

Show Call Time

Select On/Off to display/not display the elapsed time of your call.

Auto Answer

Automatic answer of an incoming call. Only works together with the Handsfree car kit accessory.

DTMF Tones

DTMF tones are emitted when pressing a key during menu prompts (e.g. during Voicemail, etc.). Select On/Off to activate/deactivate this function.

Data Services

When connected to the optional Data accessories (also see their user manuals) your phone can send and receive data.

- **Selecting a *Serial Speed***

Select *Serial Speed* and use the Jog Dial to select *Automatic*, or one of the following speeds: *115.2kbps*, *57.6kbps*, *38.4kbps*, *19.2kbps*, *9.6kbps*.

Select *Automatic* for automatic detection of the serial speed. Enter an "AT" command, whereafter the phone responds with *OK*. For a list of "AT" commands, refer to the user manuals supplied with the CMD-J5 Data accessories.

Divert

You may need to register for this service with your Network Operator/Service Provider.

Setting a Divert

- 1 Select the Divert menu from the main menu.
 - 2 Select a Divert option using the Jog Dial.
 - 3 Select *Activate* to set the chosen divert condition.
 - 4 Select *Voicemail* to divert calls to your Voicemail or choose a number from the Phonebook. Choose *Enter Number* to enter the number manually using the keypad.
 - 5 Wait for confirmation from the network.
- In step 3, you also have the option to cancel or check status. Select *Cancel* to cancel the divert; then wait for the network response.
 - Select the option *Check status* to check the divert settings. Wait for the network response and then you can view the current status on the display.
 - If the returned response is *Failed*, the network was unable to set, clear or check the selected Divert.
 -  appears in standby mode if a Divert is set.

The *Divert* menu offers the following options:

All Calls

Divert all calls unconditionally (the phone will not even ring).

If Not Reachable

Divert incoming calls when your phone is switched off or out of network coverage.

If No Reply

Divert incoming calls if you do not answer the call after a certain period of time.

If Busy

Divert incoming calls when your are on the phone (line engaged).

All Fax

Divert all fax calls (the phone will not even ring).

All Data

Divert all data calls (the phone will not even ring).

Cancel All



Clear all active diverts.

Call History

Provides a record and quick access of up to 10 of the last outgoing calls, up to 10 of the last incoming calls and up to 10 missed calls.

- 1 Select *Call History* from the Main menu or simply press  in standby mode.
 - 2 Use the Jog Dial to choose one of the following options: *Outgoing calls*, *Incoming calls* or *Missed calls*, then press the Jog Dial.
 - 3 Make a call by pressing and holding the Jog Dial on one highlighted name/number. Select *Delete All* at the end of the list to delete all names/numbers.
- *Caller ID* (Caller Line Identification) is required to support Call history entries.
 - When the *Call History* reaches its capacity, the oldest number is deleted automatically to provide space for the newest entry.

Notes

-  Outgoing call
-  Incoming call

Extras

Choose the *Extras* menu to access the following sub-menus: *Clock*, *Calculator*, *Games* and *E-mail*.

Clock

World Clock

Press the Jog Dial to select a city from the map (or press the Centre Key to list cities) for the following options:

Set 

Choose *Set*  change the home city.

Set 

Choose *Set*  to change the foreign city.

Daylight Saving

Select *Daylight Saving* to switch between summer time and winter time.

Alarm

It is possible to set, switch on/off or set the Alarm to ring at the same time every day (Repeat daily). If the phone is switched off, you will not hear the alarm.

Timer

To start and stop the timer at a certain time. When the timer is on,  appears in the display in standby mode.

Notes

The volume of the alarm/timer is determined by the ringer volume setting. If the ringer volume is off, the alarm/timer will ring at the minimum volume. The alarm/timer will still ring even during a call.

Clock Format

Choose from the following clock formats: *24 hours, am/pm, With Date, World Clock*.

Choose *Off* to have no date/time displayed in standby mode.

Clock Chime

Choose from the following *Clock Chime* options: *Beep, 8h-20h, Off*.

Set Date/Time



Use the Jog Dial and keypad to enter the day, month and year (*DD/MM/YY*) as well as the time in hours and minutes (*HH/MM*).



Important

If you insert a new battery, please reset the clock.

Calculator

The Calculator can perform addition (+), subtraction (-), multiplication (x) and division (\div).

- Press  to go through the mathematical operations of +, -, x, \div in that order.
- Press  to clear the entered value and the result.

- 1 Select *Calculator* from the main menu.
- 2 Enter a number.
- 3 Press  to select the operant and then enter another number.
- 4 Press  to select = for a result.

Currency Converter

You can also use the calculator as a currency converter.

- 1 Enter a number into the calculator screen.
- 2 Press the Centre Key.
- 3 Select the desired currency exchange rate.
- 4 Press the Jog Dial.

Currency Converter Settings

- 1 Press the Centre Key when the calculator screen is displayed.
- 2 Select *Settings* and press the Jog Dial. Select from the following:
 - *Home Currency* to set the home currency.
 - *Foreign Currency* to set the foreign currency. After setting the foreign currency, press the Jog Dial to set the *Exchange Rate*.
 - *Currency List* to edit the currency name.

E-mail

You can send and read E-mail by accessing to your office E-mail server or your Internet service provider on the Internet (POP3 and SMTP are supported). Contact your service provider or operator directly for complete details for setting information, as some service provider or operators do not provide this service. Be sure to make your settings before you start using E-mail.

Notes

- A *Security Code* may be necessary when using your browser or sending E-mail. Use the code that is set as your *Security Code*. For details see *Security Code*, page 41
- The maximum size of E-mail that can be sent or received is 2 Kbytes, including the header.

Reading E-mail

After selecting E-mail from the *Extras* menu select *Read* to connect to your server and display a list of incoming mail. Rotate the Jog Dial to highlight the E-mail that you want to read, select it with the Jog Dial to read it. Also, when you press the Jog Dial you can:

Next: Read the next E-mail

Prev: Read the previous E-mail.

Reply: Reply the E-mail by pressing the Jog Dial after selecting the sender.

Writing E-mail

After selecting E-mail from the *Extras* menu, select *Send* and you can compose an E-mail.

To: Enter the address of the person you want to send the E-mail.

Subject: Enter the subject of your E-mail.

Body: Compose the text of your E-mail.

Press the Jog Dial and select *send* to send the E-mail after entering the text.

Settings

To send and receive E-mail you need to set the following.

Enter your E-mail address correctly as indicated by your mail-server manager or your provider.

Provider

Dial-up Number: The phone number to dial-up your provider.

User Name: The user name to access your provider.

Password: The password to access your provider.

POP3 Server: The address of the mail server for receiving E-mail.

SMTP Server: The address of the mail server for sending E-mail.

Data Call Type: You can select the relay, when you connect to your provider. ISDN is already set.

E-mail

User Name: The user name to access your mail server.

Password: The password to access your mail server.

E-mail Address: Your E-mail address

Details

POP3 Port The number of the port for the mail server for the POP3 port. It is not necessary to change from the regular 110.

SMTP Port The number of the port for the mail server for the SMTP port. It is not necessary to change from the regular 25.

Timeout Set the amount of time allowed to connect to your mail server.

DNS Server The settings for DNS (Domain Name Server) server.

Scheduler

Display the calendar, save your daily schedule and set alarms for important tasks. The monthly calendar appears as follows:

7 (underline): An event is scheduled for that day.

Enter a new event or a new to do item

- 1 Select *Scheduler* from the main menu and use the Jog Dial to select a day.
(To change the month, press the Centre Key.)
- 2 Use the Jog Dial to select *New* and then enter a *New Event* or a *New To Do* item.

The following options are available if you select an event.

OK

Choose *OK* if the entry is correct to save.

View

View details of the event.

Edit Icon

Select from a range of icons to be added to the event entry.

Edit Time

Edit the Time of the event.

Alarm

Select from the following options: switch the *Alarm On/Off*, or set it 5 min./1 day before the event time. If the phone is switched off, you will not hear the alarm.

Edit Text

Use the Jog Dial and the keypad to edit the event text.

Delete

Delete the event entry.

Daily To Do List

The following options are available if you select one of the To Do Items.

View

View details of the To Do entry. Select *OK* if the entry is correct.

Complete

Select *Complete* if you have completed the *To Do* item. The *To Do* entry is ticked. It is still possible to View, undo complete (= Not complete) and to edit this entry.

Edit Text

Edit the *To Do* entry.

Delete

You have the choice of the following options:

- *Past* will permanently delete all past *To Do* entries (but keep the current entry/entries).
- *All* will permanently delete all *To Do* entries from the past and of today.

WAP

Press the Centre Key in standby mode to access the Internet or choose *WAP* from the main menu using the Jog Dial.

It is necessary to register with a service provider to use this telephone as a browser or for E-mail. In some cases registration has already been completed.

Check with your service provider in advance to confirm whether this phone has access to service. Also, check with your service provider when using this phone overseas.

Browser

You can visit various information sites on the Mobile Internet Service and Intranet information on your company. It is possible to access a variety of information such as news or weather reports from around the world, as well as regular sites on the Internet.

Notes

- A *Security Code* may be necessary when using your browser or sending E-mail. Use the code that is set as your *Security Code*. For details see *Security Code*, page 41.
- Internet access is limited to the sites that are configured in HTML or WML.
WAP (the Wireless Application Protocol created for Internet service via mobile phones) is used to access a WML site.
- You can not make phone calls while accessing the Internet.

Launching Your Browser

Press the Centre Key in standby mode to access the Internet or choose *WAP* from the main menu using the Jog Dial.

From the *WAP* menu rotate the Jog Dial and then press it to select an item from the menu.

- Home: Access your homepage.
- Favourites: Access, edit, and delete URL's that are chosen as Favourites (see *Launching the Browser from Favourites*).
- Settings: Configure the settings to access your Browser. Be sure to make these settings before using this service.

Notes

To create a Favourite during a *WAP* session, enter "wsp://" and then the URL.

Tip

To open the menu, press the Centre Key while browsing.

- Home: Access your home site.
- Refresh: Refresh the displayed page.
- Add Favourites: Store current address.
- Favourites: Access the URL from Favourites.
- Manual URL: Access the URL by manual input.
- Quit: Close your browser and return to standby mode.

Launching the Browser from Favourites

To select *Favourites* press the Jog Dial while in the *WAP* menu for a list of recorded URLs.

Rotate the Jog Dial to select the URL, then press it to display the following menu.

- Go: Connect to the selected URL.
- Move: Change the order of your Favourites.
- Edit: Edit the Favourites name and URL.
- Delete: Delete the Favourites.

Settings

The complete range of settings is displayed. The  icon indicates the site that you have set as your home site. To change your home site, select “Set home” from the menu after you choose a site with the Jog Dial. Select *Edit* and the following items can be set.

Name	Home Page	Server Type
Bearer Service	Provider	GW Server
Security	Service Centre	Proxy
Details		

<Changing the *Server Type*>

You can access the contents of both WAP and HTML servers with this browser. Select the type of server that you want to view in *Server Type*.

Notes

The items that can be set depend on the server type.

Navigation

When browsing a WAP site, press the Centre key to scroll through the options of a selection field (form field). Press the Jog Dial to select one or more items.

Press  to exit back to the previous page when browsing.

Closing the Browser

Press and hold  to disconnect (only when the bearer service is set to data) and close the Browser.

Appendix

Troubleshooting

Problem	Possible Causes	Possible Remedies
Unable to switch on	Empty battery	Charge the battery.
	Defective battery	Replace the battery. Note that after several years, gradual decline is normal.
The  icon appears	Weak signal	Move to an open space or nearer to a window.
	Outside GSM coverage area	Check operator coverage map.
	SIM not valid	Call your service provider.
	Network access not allowed	Try manual network search.
Call not possible	Dialling error	Use full national area code. When abroad, use also international access code to reach home country.
	All calls barred	Check (Password is needed to clear).
	Another SIM inserted	Check for new restrictions.
	Call barring set	Check outgoing call barring settings.
Difficult to hear the other party	—	Adjust earpiece volume, and reduce noise around you.

Problem	Possible Causes	Possible Remedies
Phones loses network	Weak signal	Reconnection, or connection to another operator is automatic. Switching phone off and on may accelerate this.
SIM error	Damaged SIM card	Please contact your service provider.
SIM card not registered	Network does not recognize the SIM card	Please contact your service provider.
Not able to receive calls	Call barring set	Check incoming call barring settings.
	Divert set	Check call divert settings.

Unlocking the SIM Card

If you enter the PIN code incorrectly 3 times, the SIM card is blocked.

- 1 Enter the PUK and press the Jog Dial (or press **#***).
- 2 Enter the new PIN (4-8 digits) and press the Jog Dial (or press **#***).
- 3 Enter the new Pin code again and press the Jog Dial (or press **#***).
The SIM is unblocked.

Notes

- If you enter the wrong unblock code (PUK) 10 times, your SIM is blocked completely. In this case contact your Network Operator / Service Provider.
- In order to receive more information (SIM and PUK), please contact your Network Operator /Service Provider.

Technical Specifications

E-GSM 900 Mobile Telephone	Class 4 (2 Watts)
GSM 1800 Mobile Telephone	Class 1 (1 Watt)
Frequency Range (Transmission)	880-915 MHz and 1710-1785 MHz
Frequency Range (Reception)	925-960 MHz and 1805-1880 MHz
Weight	85 g
Handset Operating Temperature	-10 °C – +55 °C
Accessories Operating Temperature	±0 °C – +45 °C

Licensing

Your CMD-J5 is authorized for use in GSM 900 / 1800 networks and complies with EU standards.



- This equipment complies with the essential requirements of the Directive 1999/5/EC Radio and Telecommunications Terminal Equipment Directive.
- 95/54/EC “Car Automotive Directive”
Applies to accessories used in vehicles confirmed by the e-mark.

Sony reserves the right to make changes or improvements to any of the products described in this guide without prior notice.

T9™ text input is a registered trademark of Tegic Communications Inc.

Part of the software included in this product is © Copyright STNC Ltd. 1994 - 1999 All rights reserved.

Part of the software included in this product is © Copyright Microsoft Corporation 1999 - 2000 All rights reserved.

Index

- A**
Any Key Answer 43
Auto Answer 44
Auto Redial 44
- B**
Backlight 38
Battery Pack
 Charging 11
 Inserting 11
- C**
Calculator 50
Call Cost 41
Call History 47
Call Hold 17
Call Time 41
Call Waiting 19, 43
Caller ID 43
Centre Key 6
CIPHERING 16
Clock
 Alarm 49
 Set 49
 Timer 49
Connection 14
- D**
Data Services 44
Divert 45
DTMF 18
- E**
E-mail 52
Emergency Calls 7, 39, 40
Error Tone 36
Event Sounds 36
- F**
Factory Reset 38
- G**
Games 9
Greeting Message 37
- H**
Headset 16
- J**
Jog Dial 5
- K**
Key Click 36
Keypad Locked 7
- L**
Language 37
LCD Contrast 38
Local Area Info 34
Loudspeaker 18
- M**
Memory Info 37
Microphone On/Off 18
- N**
Network 14
- O**
One Minute Beep 44
- P**
Phonebook
 Creating Entries 25
 FDN Phonebook 26
 Grouping 25

Making Calls	23	Reply	32
Note	29	Reply Cost	33
Own Number	24	Result Report	34
Saving Entries	23	Service Centre	34
Search	27	Validity period	33
Service Dialling		Speaker Volume	
Numbers	26	Adjusting	17
PIN	13, 39		
PIN2	39	T	
Preferences	37	T9 Text Entry	22
Preferred List	38		
R		V	
Ringer Type	35	Vibra Alert	6
Ringer Volume	35	Voicemail	6, 27
Adjusting	17	W	
Roaming	14	Wallpaper	38
		WAP	56
S			
Scheduler	54		
Event	54		
To Do	55		
Security Code	41		
Select Line	43		
Select Network	38		
Selection	14		
Side Switch	6		
Signal Strength	14		
Silent Mode	6		
SIM Card			
Inserting	10		
Removing	10		
Single Beep	6		
SMS (Messaging)			
Create	31		
Delete	32		
Edit	32		
Forward	32		
Memory class	33		
Message Format	34		
Read	30		