

Contents

	Copyright and Legal Information	v
1	Your phone	1
	Layout - front	1
	Layout - back	2
	Menus	3
	Display indicators	4
2	Getting started	6
	Removing the back cover	6
	Removing the battery	6
	Inserting the SIM card	6
	Inserting the battery	7
	Replacing the back cover	7
	Charging the battery	7
3	The basics	9
	Switching on/off	9
	Navigation and scrolling	9
	My number	9
	Screensaver	9
	Power save	9
	SIM Toolkit	10
	Shortcuts	10
	Entering text, numbers and symbols	10
4	Calls	13
	Making a call	13
	Answering a call	14
	In-call options	14
	Adjusting the volume	15
	Using the calls list	15
5	Messages	16
	Using Messages	16
	Text messages	16
	MMS messages	19
	Sending an MMS message	20

Using templates	22
Sorting and deleting messages	22
Calling your voice mail	22
SMS and MMS settings	23
6 Internet	25
Internet settings	25
Internet menu	25
Connecting to an internet page	25
Downloading	25
In browser options	26
Setting your homepage	26
Bookmarks	26
Settings	27
7 Personalise your phone	29
Ringtones	29
Sounds	29
Volume and vibrate	29
Display	30
Covers	30
Wrist/neck strap	32
8 Contacts	33
Phone contacts and SIM contacts	33
Adding a contact	33
Finding a contact	36
Copying contacts	36
Deleting contacts	36
Fixed names	36
Additional Contacts menu options	37
Calls list	38
9 Camera	39
Taking a photo	39
Sending a photo	39
Photo options	40

Camera options	40
Memory	41
Timeout	41
Editing your photos	41
10 Games	42
Funny Farmer	42
Solitaire	44
Sumito	44
Tenpin	45
Splat	45
Volume	45
11 Applications	46
Calculator	46
Converter	46
12 Java	48
Downloading and installing	48
Deleting	48
Options	49
13 Pictures/Sounds	50
Pictures	50
Sounds	51
14 Settings	53
Languages	53
Time/Date	53
Alarm	53
Display	54
Sounds	54
Advanced	55
Data accounts	56
Shortcuts	57
Auto key lock	57
15 Services	58

Commands	58
Network sel. (selection)	58
Send number	58
Cost/timers	58
Divert	59
Call waiting	59
Broadcast	59
16 Troubleshooting	60
17 Regulatory Statements	64

Copyright and Legal Information

The wireless phone described in this manual is approved for use in GSM 900 and 1800 networks.

This manual and the accompanying Safety, Warranty and Licence booklet are available for download from www.sendo.com.

Copyright Information

Part number: 8E30-T4011-50001 (Edition 1).

Copyright Sendo 2004. All rights reserved.

Printed in the EU.

Sendo, the Sendo logo, the Sendo "D" and the Sendo model P600 phone are trademarks or registered trademarks of Sendo International Ltd. and/or its affiliates. All rights reserved.

Reproduction, transfer, distribution or storage of part or all of the contents in this document in any form without the prior written permission of Sendo is prohibited.

T9 Text Input is a registered trademark of Tegic Communications. All rights reserved. T9 Text input is licensed under one or more of the following U.S. Patents: 5,818,437, 5,953,541, 5,945,928, 6,011,554 and additional patents are pending worldwide.



Java and all Java-based trademarks and logos are trademarks or registered trademarks of Sun Microsystems, Inc. in the U.S and other countries. The names of actual companies and products mentioned herein may be the trademarks of their respective owners.

Disclaimer

The information contained in this user guide is written for the Sendo model P600 phone. Sendo reserves the right to make changes and improvements to the products and any of the features of the products described in this document, and/or this document itself, without prior notice.

THE CONTENTS OF THIS DOCUMENT ARE PROVIDED "AS IS". EXCEPT AS REQUIRED BY APPLICABLE LAW, NO WARRANTIES OF ANY KIND, EITHER EXPRESS OR IMPLIED, INCLUDING, BUT NOT LIMITED TO, THE IMPLIED WARRANTIES OF MERCHANTABILITY AND FITNESS FOR A PARTICULAR PURPOSE, ARE MADE IN RELATION TO THE ACCURACY, RELIABILITY OR CONTENTS OF THIS DOCUMENT. SENDO RESERVES THE RIGHT TO REVISE THIS DOCUMENT OR WITHDRAW IT AT ANY TIME WITHOUT PRIOR NOTICE. UNDER NO

CIRCUMSTANCES SHALL SENDO BE RESPONSIBLE FOR ANY LOSS OF DATA OR INCOME OR ANY SPECIAL, INCIDENTAL, CONSEQUENTIAL OR INDIRECT DAMAGES HOWSOEVER CAUSED.

Export Information

This phone may be subject to export regulation of the United Kingdom and other countries. Diversion contrary to law is prohibited. You must comply with all applicable export laws, restrictions and regulations of the United Kingdom or foreign agencies or authorities, and shall not export, or transfer for the purpose of re-export, the phone or any part of the phone in violation of any applicable restrictions, laws or regulations, or without all necessary approvals.

For Your Safety

You should observe and follow the guidelines given in this manual for the safe and efficient use of your phone. Failure to comply with these guidelines and requirements may void your warranty and may invalidate any approvals given to the phone.

Please read this manual in conjunction with the Safety, Warranty and Licence booklet provided (and in particular the safety section), before you use your phone.

⚠ Warning: Throughout the main body of this manual, text in this format is used to act as a warning. Please read each warning carefully.

This phone is equipped with an internal antenna on the top area of the phone. Avoid touching or covering the antenna as detailed in the Safety section of the Safety, Warranty and Licence booklet supplied with this manual.

Safety, Warranty, Licence

Please refer to the information contained in the Safety, Warranty and Licence booklet supplied with this manual. The booklet contains important Safety, Warranty and End User Licence Agreement information.

Approved Accessories Warning

Use only batteries, chargers and accessories approved by Sendo for use with this phone model. The use of any other types may invalidate any warranty applying to the phone, and may be dangerous. For availability of approved accessories,

please check with your dealer or visit
www.sendo.com.

When you disconnect the power cord of any
accessory, grasp and pull the plug, not the cord.

Network Services



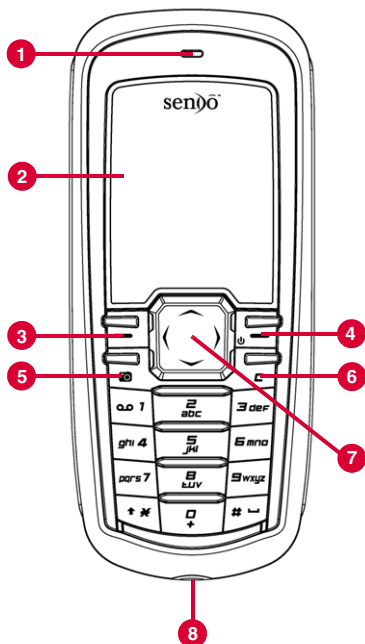

A number of features included in this guide are called network services. They are services provided by wireless service providers. Before you can take advantage of any of these network services, you must subscribe to these service(s) from your home wireless service provider and obtain instructions for their use. Some of these network services may not be available when roaming on a network other than your home network.

1 Your phone



Colours and layout shown above may not exactly match the phone supplied.

Layout - front

- 1 Earpiece**
- 2 Display** – Display indicators, menu options and other information is shown here.
- 3 Left soft key**  – This key performs the function immediately above it on the display.
- 4 Right soft key/Power key**  – A short press of this key performs the function immediately above it on the display. A long press of this key will switch the phone on and off.
- 5 Camera key**  – Opens the Camera feature.
- 6 Clear key**  – This key erases text or takes you back to your previous step, depending on what you're doing. A long press of this key takes you back to the main screen.
- 7 Navigation keys**  – Used to scroll up, down, left and right in menus and features.
- 8 Charger/accessories connector** – Insert the charger connector here. This connector is also used to connect accessories such as a hands-free kit.

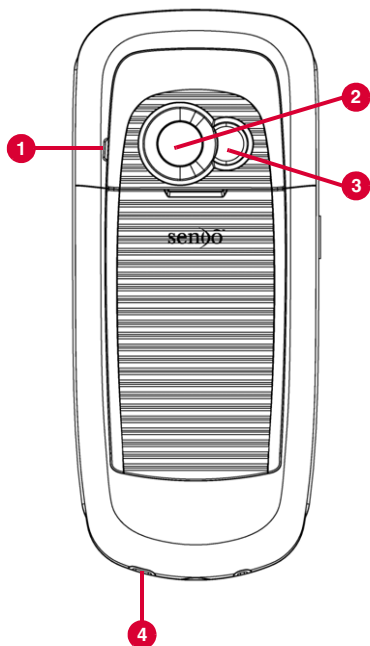

Layout - back

- 1 Speaker** – Used to play ringtones, alerts and sounds.
- 2 Camera lens** – Used for the digital camera.
- 3 Self-portrait mirror** – Used to take a photo of yourself. Look at the self-portrait mirror and position your reflection in the centre of the mirror. When you take a photo, your image will be aligned correctly.
- 4 Wrist/neck strap aperture** – Used to attach a wrist strap or neck strap. See the *Wrist/neck strap* section on Page 32 for details.

Colours and layout shown above may not exactly match the phone supplied.

Menus

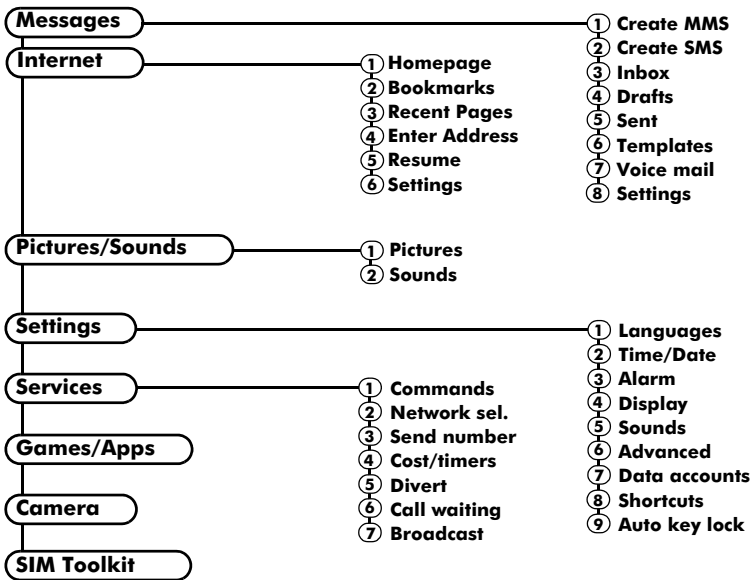

Available menu items and features may vary by model of phone and network service provider.
Please review your phone's menu to determine the menu items and features available on your phone.

Display indicators

Main screen

Indicator	Meaning
	Battery level - low
	Battery level - high
	Battery charging (phone on)
	Battery charging (phone off)
	Signal strength - weak
	Signal strength - strong
	GPRS service available
	GPRS service not available (these icons are network dependent)
	New SMS, EMS or MMS message
	New voice mail message (this icon is network dependent)
	Indicates you had a missed call
	All incoming calls are diverted
	Keypad locked
	Silent mode active
	Alarm clock set

In contacts lists

Indicator	Meaning
	Mobile phone number
	Work phone number
	Home phone number
	Email address
	SIM contact

In messages list

Indicator	Meaning
	Message has not been read (subject text in bold)
	Message has been read (normal subject text)
Yellow icon	MMS (multimedia) message
Blue icon	SMS (text) message



In calls list

Type	Meaning
	Mobile number
	Work number
	Home number
	SIM contact
	Unknown contact





Direction	Meaning
	Incoming call from a number
	Outgoing call to a number
	Missed call from a number

Note: The Type and Direction icons are used together to indicate the number/contact type and the direction of the call. For example, indicates an incoming call from a work number stored in your contacts.

In lists

Indicator	Meaning
	Shows the option that is currently activated
	Indicates that more information is available. When a line like this is highlighted in features such as the contacts list, the text will scroll automatically to reveal the additional information.





Text entry

Indicator	Meaning
	Multitap text input - lower case
	Multitap text input - upper case
	T9 predictive text input (lower case)
	T9 predictive text input (upper case)
	Numeric mode

Internet

Indicator	Meaning
G	GPRS WAP session
C	GSM WAP session

Camera

Indicator	Meaning
	Photo size setting:
L	Large
M	Medium
S	Small
XS	Extra Small
LP	Large Portrait
SP	Small Portrait
	White balance (if not set to Automatic)
	Sharpness (if not set to zero).
	Timer active
	Multishot active
5	Photos remaining counter. For example, this icon indicates that another 5 photos can be stored on the phone (with the available memory and current resolution and quality settings).

2 Getting started

To use your phone, you must first insert the SIM card supplied by your network service provider, and then charge the battery.

Removing the back cover

Press down on the area on the top of the back cover, slide the cover down and lift off.

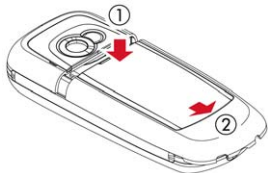

Removing the battery

If you need to remove the battery, press down on the tab at the centre of the bottom edge of the battery and lift out.

Note: Always turn your phone off before you remove the battery.

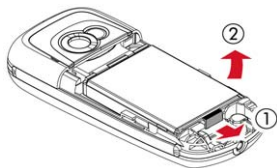

Inserting the SIM card

Note: You cannot insert or remove the SIM unless you remove the battery. Always turn your phone off before you remove the battery. See the *Removing the battery* section above for details.

Slide the SIM into place, starting with the shorter edge first, making sure that the gold-coloured contacts of the card are facing down, touching the contacts of the phone.

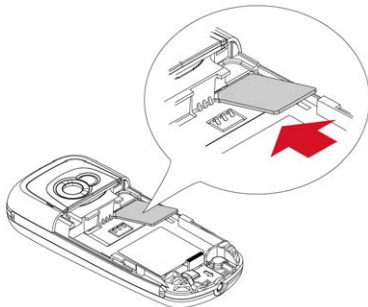

Warning: Keep all SIM cards out of reach of small children. This small part can be swallowed.

Warning: The SIM card is easily damaged by scratches or bending, so be careful when inserting and removing the card.

Inserting the battery

Insert the battery into the phone, starting with the top edge first. Align the tabs on the edge of the battery with the tabs on the back of the phone. Make sure the gold-coloured contacts of the battery are touching the contacts on the phone. Push down into place.

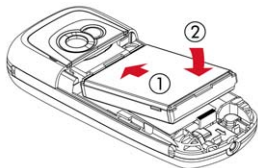

Warning: Do not insert the battery with the phone's front cover removed.

Replacing the back cover

Place the cover onto the back of the phone and slide the cover into place, making sure the tab at the top of the cover clicks into place.

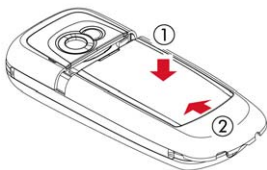

Charging the battery

You must charge the battery for at least 12 hours before using the phone for the first time. After this, the battery will normally take around 3 to 5 hours to charge.

Insert the connector on the charger lead into the connector on the bottom of the phone. Plug the charger into a wall socket. When charging commences, an animated charging icon or charger cable icon appears. When the battery is fully charged, a full battery icon will appear and you can disconnect the charger.

Warning: Only use chargers designed for use with your P600 and approved by Sendo. Incorrect use of chargers, or use of any other charger, may damage your phone and may invalidate your warranty.

Once you connect the charger, you can switch your phone on. If the battery is completely empty, it may take a few minutes before you can make or receive a call once you plug the phone into a charger.

Note: When the battery is completely discharged it may take some time for the battery charging icon to appear after you have connected the charger.

Charging and Discharging

Please observe the following notes and precautions regarding the use of batteries and related equipment.

Note

Do not charge the battery with either of the phone covers removed.

If you remove your battery you will find the phone's label on the back portion of the phone. This label includes information about the phone, such as the model number.

Do not remove the phone's label. In the unlikely event that you ever need to make a warranty claim or seek assistance with respect to use of your phone, you may be asked for this information.

Note that a new battery's full performance is achieved only after two or three complete charge and discharge cycles. The operation times provided are reasonable estimates and may be affected by network conditions, charging and phone usage.

The battery can be charged and discharged hundreds of times, but it will eventually wear out. When the operating time (talk time and standby time) is noticeably shorter than normal, it may be time to buy a new battery.

Note

Caution: Only use batteries approved by Sendo and recharge your battery only with the chargers approved by Sendo. When a charger is not in use, disconnect it from the power source. Do not leave the battery connected after the battery indicator shows that the battery is full, or for longer than a single day, since overcharging may shorten its life. If left unused a fully charged battery will discharge itself over time.

For longer operation times, discharge the battery from time to time by leaving your phone switched on until it turns itself off and the battery is fully discharged.

Do not attempt to discharge the battery by any other means.

Use the battery only for its intended purpose.

Never use any charger or battery that is damaged or worn out.

Warning: Do not short circuit the battery. All batteries can cause property damage, injury or burns if a conductive material such as jewellery or keys comes into contact with the exposed terminals. The material may complete an electrical circuit and become quite hot. Exercise care in handling your phone battery. For example, avoid carrying your phone battery loose in a pocket or purse. This product is designed for use with Sendo-approved batteries only. Use of unapproved batteries may be dangerous and may cause damage to the battery or the phone and may void your warranty.

Leaving the battery in hot or cold places, such as in a closed car in summer or winter conditions, may reduce the capacity and lifetime of the battery. Always try to keep the battery between 15°C and 25°C (59°F and 77°F). A phone with a battery that has been exposed to temperature extremes may temporarily not work, even when the battery is fully charged.



Dispose of the battery properly. Comply with all local laws or regulations in disposing of your battery. Do not dispose of batteries in a fire.



3 The basics

Switching on/off

To switch the phone on, press .

If the phone asks for a PIN code, enter the code that is supplied with the SIM card. The code will be displayed as asterisks. When complete, press , **OK**.

When you switch the phone on for the first time (or after removing the battery) you may also be asked to enter the date (in the format dd/mm/yyyy). When complete, press , **OK**. You will then be asked to enter the time (in 24 hour format). When complete, press , **OK**.





 **Note:** If you make a mistake, use the  and  navigation keys to move between the characters.



Wait a few seconds while the phone searches for the network. Once the network has been found, the main screen appears and your phone is ready to be used. The main screen shows the network name and two icons giving the signal strength (top right) and battery level (top left).





To switch the phone off, press and hold .

Navigation and scrolling

To enter the main menu on your phone, press , **Menu** from the main screen.

You can scroll through menus using the up and down keys,  and . When you find the menu option that you are looking for, press , **Select** to activate. Press , **Back** or  to return to the previous level.

In certain features such as entering text messages, you can also use the left and right keys,  and , to scroll left and right.



When scrolling in menus or messages, continue to hold , ,  or  to increase the scrolling speed.

 **Tip:** See the *Shortcuts* section on Page 10 for details of useful menu shortcuts.

My number



Your phone number is stored on your SIM card and should be stated in the documentation that came with the card.

If you need to remind yourself of your number, try calling another mobile phone and make a note of the number that appears on that phone's display. Alternatively, contact your network service provider.

Your number may also be available through the My number feature (if set by your network service provider). Press , **Contacts** from the main screen and select the **My number** option. Select **Consult**, press , **Options** and select **Details** to display your phone number (press  to return to previous screens).

Screensaver



A screensaver is a picture or animation that is displayed when the phone has been idle for a certain amount of time.

When the screensaver is displayed, press any key to return to normal display (or press , **Unlock** then  if the keypad is locked).

To modify the screensaver settings, see the *Display settings* section on Page 54.

Power save

To get better battery performance, your phone will automatically switch to power save mode after it has been idle for a certain amount of time. In this mode, the screen's backlight is switched off and a clock is displayed showing the current time.

When the power save mode is active, press any key to return to normal display (or press , **Unlock** then  if the keypad is locked).























SIM Toolkit

Your network service provider may offer some special services or features using the SIM Toolkit menu. However, the name of this menu may change to indicate the type of service, for example “*Information*”.

For more details, please contact your network service provider.





Shortcuts

Shortcuts to some useful features:

Shortcut	Description
	You can set what features are accessed when you press the  ,  ,  or  navigation key from the main screen. Try each key from the main screen to see what features they are currently set to. The <i>Shortcuts</i> section on Page 57 describes how to change the settings.
Lock keypad	To lock the keypad, press  , then  from the main screen. The locked symbol,  , is displayed on the main screen when the phone is locked.
Unlock keypad	To unlock the keypad, press  , <i>Unlock</i> then  .
Silent mode	To enter/exit silent mode press  then  from the main screen. The silent symbol,  , is displayed on the main screen when the phone is in silent mode.
Silence ringtone	If you can't answer a call, but you don't want to reject it, press  to silence the ringtone.
Scrolling	When scrolling in menus or messages, continue to hold  ,  ,  or  to increase the scrolling speed.
Language	If the phone language is changed by mistake, press and hold  from the main screen to display the language list. Scroll to the language you want (using  and ) and press  .

Entering text, numbers and symbols

You can enter text, numbers and symbols on your phone in a number of ways. The current input mode is indicated at the bottom of the screen (in features such as messaging) by one of these icons:



-  Multitap text input - lower case
-  Multitap text input - upper case
-  Numeric mode
-  T9 predictive text input (lower case)
-  T9 predictive text input (upper case)

You can switch between Multitap, numeric and predictive text modes manually by repeatedly pressing .

 **Note:** When you are in screen that requires text or numeric entry, the phone automatically changes to the appropriate input mode.

The table below lists the characters associated with each key on the numeric keypad:

Key	List of characters available
1	1 . , @ ' ? ! " : ; & i
2	a b c 2 à á â ã æ ç
3	d e f 3 é ê
4	g h i 4 l
5	j k l 5
6	m n o 6 ñ ò ó ø
7	p q r s 7 ß
8	t u v 8 ü ù
9	w x y z 9
0	0 (numeric mode only)
#	Space (short press)

 **Tip:** For all input modes, a long press on  displays a table showing all the symbols available. See the *Entering symbols* section below for details.

Multitap standard text input

When you are in Multitap mode (sometimes called multipress mode), you enter a letter by pressing the number key on which the letter is printed. Press the key repeatedly until the required character is displayed. If you pass the character you want, keep pressing the key to scroll through all the characters again.

For example, to enter the letter "r" press **[7]** three times.

If a word you are entering contains two consecutive letters which are located on the same key, enter the first one and then wait for the cursor to reappear before entering the second.

Also, you will notice that some intelligent features are built in. For example, when entering the first word in a sentence, the text input mode changes automatically from upper case to lower case after the first letter.

Some punctuation marks (including full stops, hyphens and apostrophes) are available on **[0]**. Alternatively, press and hold **[*]** to pick a symbol to insert from the character table (see the *Entering symbols* section below).

When you have finished entering a word, press **[space]** to enter a space and move on to the next word.

For example, to enter the name "Ross" when you are in lower case mode:

- 1 Press **[2]** to enter upper case mode,
- 2 Press **[7]** three times, to display "R", you will then return to lower case mode.
- 3 Press **[6]** three times, to display "o".
- 4 Press **[7]** four times, to display "s". Now pause slightly until the cursor reappears.
- 5 Then press **[7]** four times, to display "s".

Predictive text input

To save time when you are writing a text message or MMS message, your phone has a built-in dictionary feature which uses the letters that you are typing to complete the word.

This input method allows you to simply press each key once. For example, to write the name "Ross", press **[7]**, then **[6]**, then **[7]**, then **[7]** just once each.

The word may change as you type, but don't worry about what is on the screen until you have finished the word. Sometimes different words share the same sequence of key presses. If the finished word is wrong, press **[↵]** to scroll through other possibilities. If the word that you are looking for is still not there, press **[↵]** repeatedly to change the text mode to **[AB]** or **[ab]** and enter the word again.

After you have completed a word, press the space key **[space]** to enter a space and move on to the next word. Press and hold **[*]** to pick a symbol to insert from the character table (see the *Entering symbols* section below).

Some intelligent punctuation (including full stops, hyphens and apostrophes) are also available on **[0]**. The punctuation mark is completed when you enter the next keystroke.

Entering numbers

To enter a number in upper case or lower case text input mode, simply press the number key repeatedly until the number is displayed.

To enter a number in predictive text input mode, press the number key and then scroll through the characters (by pressing **[↵]**) until the number is displayed.





If you have multiple numbers to enter, it is often more convenient to use the numeric input mode. Press **[↵]** repeatedly to change the mode to **[123]**. Now whenever you press any of the number keys, only the number is entered.

Entering symbols

For all input modes, a long press on  displays a table, similar to the one below, showing all the symbols available to you:

.	,	-	!	?	@	()	:
&	'	"	/	_	;	\$	%	+
*	=	<	>	#	£	¥	Δ	□
§	Γ	ι	θ	Λ	Ξ	Π	Σ	Φ
Ψ	Ω	ζ	ι	à	ä	â	æ	ç
é	è	Ä	À	É	ò	ñ	Æ	€
[]	{	}	\		~	^	
1	2	3	4	5	6	7	8	9

▶ To enter a symbol:

- 1 Press and hold  to display the symbol table.
- 2 Use the  and  keys to scroll to the row containing the symbol you want.
- 3 Press the numeric key ( to ) to select the symbol.



Making a call

Dialling a number



- 1 Key in the area code and number that you want to call, then press , *Call* to dial.

If you make a mistake, press  to delete a single number.

To delete the entire number and return to the main screen, press and hold .

- Tip: Press and hold  until the letter *p* appears to insert a pause of 3 seconds. This can be used, for example, with certain telephone banking systems.
- 2 To end the call, press , *End*.

Making an international call





- 1 Press and hold  until the plus sign "+" is displayed. This replaces the international access code.
- 2 Enter the country code, area code, and phone number.
- 3 Press , *Call* to dial.

Making an emergency call

- 1 Key in the emergency number for your present location (e.g. 999, 911, 112 or other official emergency number). Emergency numbers vary by location.
 - 2 Press , *Call* to dial.
- Warning: To make an emergency call, the phone must be switched on, properly charged and used in a service area with adequate signal strength. Also, emergency calls may not be possible when certain network services or phone features are in use. Do not rely on your mobile phone as your only method of emergency communications.

Making calls from the contacts list

- Quick tip:  *Contacts* ▶  *Search* ▶  /  ▶  *Call*

- 1 Press , *Contacts* from the main screen and select *Search* to display your contacts list.
- 2 Type in the first letter(s) of the name or scroll (using  and ) to the contact that you want.
- 3 Press , *Call* to dial. If the selected contact has more than one phone number stored, e.g. *Mobile, Work, Home*, scroll to the number you want in the list displayed, and press , *Call* to call the number. The favourite number for the contact is highlighted first.



For more information about creating and using your contacts list, see the *Contacts* chapter on Page 33.

Making a call from the calls list

The phone stores a list of your recent incoming, outgoing and missed calls.

▶ To dial a number from the calls list

- Quick tip:  *Contacts* ▶  *Calls list* ▶  /  ▶  *Call*

- 1 Press , *Contacts* from the main screen, and select the *Calls list* option to display the calls list.
- 2 Scroll and find the entry that you want and press , *Call* to dial.







For information about the calls list, see the *Using the calls list* section on Page 15.

Speed dialling

This feature allows you to dial a number simply by pressing and holding a single key.

For more information about creating and deleting speed dials, see the *Contacts* chapter on Page 33.

▶ To add a speed dial

-  Find it:  **Contacts** ▶ **Search**
- 1 Type in the first letters of the name or scroll and find the one that you want.
 - 2 Press and hold one of the keys  to  until the key number appears on the left of the screen, beside the name. This indicates that the speed dial is successfully assigned.
-  **Note:** If the contact has more than one phone number stored, e.g. *Mobile*, *Work*, *Home*, the speed dial is linked to the favourite number.
 -  **Note:**  is normally reserved for voicemail.



▶ To make a call using speed dial

- 1 From the main screen, press and hold the number key assigned to the contact you want to call.
-  **Note:** If the contact has more than one phone number stored, e.g. *Mobile*, *Work*, *Home*, the favourite number is called.

Answering a call

To accept a call press , **Accept**.

To reject a call, press , **Reject**.

-  **Note:** If you can't answer a call, but you don't want to reject it, press  to silence the ringtone.

Call waiting

This feature means you are informed of a second incoming call by an audible melody in the earpiece.



-  **Note:** Please refer to the *Call waiting* section on Page 59 for more information on how to activate call waiting.

Press , **Accept** to put the current call on hold and activate the second call.

Press , **Reject** to reject the second call.

To end the active call and return to the held call, press , **End**.

To switch between calls, press , **Options** and then select the **Swap** option.

In the main screen, the active call is shown using the  icon and the call on hold is shown using the  icon.

-  **Note:** Your network may not support call waiting or may require you to subscribe to this feature. If you do not have call waiting or are roaming on another network, accepting a second call will end the first call (or you simply may not be able to accept another call). You will not be able to switch between calls.

Conference calls

This feature allows you to connect all parties when you have accepted two incoming calls.

During the call, press , **Options** and select **Conference** to connect the callers.

To end the call, press , **End**.

-  **Note:** Conference calls is a network service. You may have to subscribe to this service and it may not be available when roaming. Check with your network service provider for details.

In-call options

When you are in a call, you can press , **Options**. The possible menu options are listed below.

Select this	To
Contacts	Access your contacts list.
Hold/Unhold	Put the active call on hold/reactivate the held call.
Mute/Unmute	Switch the microphone off/on.
Send message	Send a text message.
Swap	Swap between the current call and the call on hold.
Conference	Connect all current callers.

Select this	To
<i>SIMToolkit</i>	Access the SIM Toolkit.
<i>End all</i>	End all calls.

Adjusting the volume

The earpiece volume can be adjusted during a call. Press to make the speech louder and to make it quieter.

Using the calls list

Find it: *Contacts* ▶ *Calls list*

The phone stores a list of your recent incoming, outgoing and missed calls.

The list stores up to 30 entries. If a number is stored in your contacts list, the contact name is displayed.

Type and Direction icons on the left of the screen indicate the type of number/contact and the direction of the call:

- Mobile number
- Work number
- Home number
- SIM contact
- Unknown contact
- ▶ Incoming call from a number
- ◀ Outgoing call to a number
- ✕ Missed call from a number

For example, ▶ indicates an incoming call from a work number stored in your contacts.

Making a call from the calls list

▶▶ Quick tip: *Contacts* ▶ *Calls list* ▶ / ▶ *Call*

Press , *Contacts* from the main screen, and select the *Calls list* option to display the calls list. Scroll and find the entry that you want and press , *Call* to dial.

Calls list options

When you have highlighted an entry in the calls list, press , *Options* to display the menu options listed below.

Select this	To
<i>Save no.</i>	Save the number to your contacts list.
<i>Send message</i>	Send a text message or MMS message directly to this entry.
<i>Details</i>	View the details for this entry.
<i>Delete</i>	Delete this entry.
<i>Delete all</i>	Delete all entries in the calls list.

5 Messages

This chapter shows you how to create, send, receive, and manage different types of messages:

Text messages

Simple and special text messages. See the *Text messages* section below.

MMS messages

Multimedia (MMS) messages that can contain text, pictures, and sounds. See the *MMS messages* section on Page 19.

Vicemail messages

Voice messages from your voice mailbox. See the *Calling your voice mail* section on Page 22.

For information on using predictive text and multitap text input methods, see the *Entering text, numbers and symbols* section on Page 10.

-  **Note:** The contents of the *Messages* menu may vary by network service provider. Please review your phone's menu to determine the menu items and features available on your phone.

Using Messages

-  Find it:  *Menu* ▶ *Messages*

At the top of the *Messages* menu are the *Create* options, which provide a shortcut to sending an SMS or MMS message. The rest of the list shows the default Messages folders:

-  **Note:** The number of messages that can be stored depends on the size of each message.

Inbox

Contains received SMS and MMS messages.

Drafts

Stores messages you have created and saved.

Sent

Stores messages sent from your phone.

Templates

Stores a set of SMS and MMS templates that you can use to generate a new message.



Text messages

You can send and receive text messages to/from any compatible phone. See the *Compatible formats* section on Page 18 for details of the types of text message you can send and receive.

Reading a text message



When you receive a text message, the envelope  icon is displayed at the top of the main screen.







- 1 Press , *Read* to display the new message directly from the main screen.

If you have received more than one message, the *Inbox* is displayed. Scroll to the message using the  and  keys and then press , *Select*.

To read old messages, go to the Inbox:

-  Find it:  *Menu* ▶ *Messages* ▶ *Inbox*

Scroll to the message using the  and  keys and then press , *Select*.

- 2 The message is displayed including any ringtones, pictures, logos, icons, animations or sounds. Use the , ,  and  keys to scroll through the message.
 -  **Note:** Sounds cannot be saved from a text message and are played once, when the message is opened.
- 3 Press , *Options* to access the message options listed below:

Select this To

<i>Delete</i>	Remove the message.
<i>Reply</i>	Send a text message to the sender.
<i>Call</i>	Call the sender. Alternatively if there is a number in the message, highlight it and select this option to call the number.

Select this To

Save no. Add the sender's phone number to your contacts list.

Save picture Save a picture which appears in the incoming message. The picture is stored in your *Pictures* list. See the *Pictures* section on Page 50 for more details.

 **Note:** This option is only displayed if a picture is included in the message and you are allowed to save it.

Save ringtone Save a ringtone which has been sent with the incoming message. The ringtone is stored in your *Sounds* list. See the *Sounds* section on Page 51 for more details.

 **Note:** This option is only displayed if a ringtone is included in the message and you are allowed to save it.

Time/date Display the date and time of the message.

 **Note:** If this option is not displayed, the date and time information will be contained in the message.

Forward Send the message to someone else.



 **Note:** You may be prevented from sending items that are copy protected.

Sending a text message

▶ To send a text message from Messages

 Find it:  *Menu* ▶ *Messages* ▶ *Create SMS*

1 Write your message using the numeric keypad. See the *Entering text, numbers and symbols* section on Page 10 for details of entering text. When you have finished, press , *Send*.

 **Tip:** You can save messages to your *Drafts* folder to send later. Press , *Options* and select the *Save* option.

2 Enter the destination phone number, or press , *Contacts* and select a name and number from your contacts list.

 **Note:** If you reply to a message, you do not have to re-enter the number. This is done automatically.

3 Press , *Send* to send the message.

 **Note:** You can save messages you send to others in your *Sent* folder (if you have sufficient memory remaining). See the *SMS and MMS settings* section on Page 23 for details.

▶ To send a text message from contacts

1 Press , *Contacts* from the main screen and select *Search* to display your contacts list.

2 Scroll to a contact, press , *Options* and select *Send message* then *Create SMS*.

3 Enter your message and send it in the normal way. The favourite number for the contact will be used for the message - you can change this if you need to.

▶ To send a text message from the main screen

1 Enter the phone number you want to send a text message to.

2 Press , *Options* and select *Send message* then *Create SMS*.

▶ To send a text message from the calls list

 Find it:  *Contacts* ▶ *Calls list*



1 Scroll to an entry in the calls list, press , *Options* and select *Send message* then *Create SMS*.

Sending ringtones, pictures and more



You can send ringtones, simple pictures, sounds, and contacts in your text messages to compatible phones. See the *Compatible formats* section on Page 18 for details of the types of text message you can send and receive.

From the message screen, select **Options**  and select the relevant option:

Select this To

Add picture Add a picture. Scroll to the picture you want to insert into the message. Press  **Select** to display the picture, and then press  **Add** to add it to your message.

 **Note:** Unlike MMS messages, you can only send simple pictures in text messages. Only compatible pictures will be shown here.

Add contact Add a contact. Scroll to the contact you want to insert into the message. Press  **Select** to display the contact information, and then press  **Add** to add it to your message. The contact information is added as text (name and number) to your message.

Add ringtone Add a ringtone. Scroll to the ringtone to insert into the message and press  **Add**.

Add sound Add a sound. Scroll to the sound to insert into the message and press  **Add**.

 **Note:** You may be prevented from sending items that are copy protected.

Compatible formats

You can send and receive text messages of up to 160 characters to any compatible phone. This is known as an SMS (Short Message Service) message and is supported by almost all mobile phones.

If a text message you send or receive is any longer than 160 characters, it is automatically broken down into several small messages, which are joined together as one message when all of the small messages have been received.

 **Note:** When you send a long text message, if the phone receiving the messages does not support this feature,

then the messages are received separately and may not be in the correct order.

You can also send and receive special text messages that can contain ringtones, contacts or simple messaging pictures, logos, icons, animations or sounds. These text messages are often referred to as EMS (Enhanced Messaging Service) messages or Smart messages. Your Sendo P600 phone can send SMS and EMS messages and receive SMS, EMS and Smart Messaging messages.

Any phone you send an EMS item to, must support EMS messages. EMS pictures can display differently on other mobile phone makes and models. If SMS only is supported, only the text content will be received by the other user.

The table below lists the compatible formats for EMS and Smart Messaging items supported by the P600.

Item	Format
Ringtone	EMS (send and receive): sp-midi polyphonic ringtones, plus i-melody monophonic ringtones. Smart Messaging (receive only): Standard Smart Messaging monophonic format only.
Picture Logo Icon	EMS (send and receive): All bitmap formats (black and white, greyscale, colour) supported. Smart Messaging (receive only): Logos and icons only.
Animation	EMS only (send and receive): Standard EMS animations.
Sound	EMS only (send and receive): Standard EMS sounds.

 **Note:** You may be prevented from sending items that are copy protected.

MMS messages

You can send and receive MMS (multimedia) messages to/from other mobile phones or Email addresses. MMS messages are messages which can contain text, pictures (photos, graphics, animations, etc) and sounds (alerts, ringtones, etc). The P600 supports all standard MMS formats.

Note: The maximum message size supported by the P600 phone is 100KB. However, this may be limited further by your network. Contact your network service provider for details.

MMS connection

Before you can begin sending and receiving MMS messages you must have set up GPRS connections for MMS messaging. These settings may have already been configured on your phone by your network service provider. Simply try sending an MMS message or check with your network service provider for details.

Note: You need GPRS and MMS enabled for your SIM card, to send and receive MMS messages. Contact your network service provider for information.

If your phone is not configured already, the fastest and easiest way to do this is to visit:

<http://www.sendo.com/config>

to automatically configure your settings. The Sendo Easy Configurator sends an SMS message to your phone containing the settings you require. Alternatively, you can ask your network service provider to send you this information (if available).



See the *SMS and MMS settings* section on Page 23 for details of how to configure your phone's GPRS connection settings for MMS messaging.

Note: Your network service provider can tell you what MMS services are available, and what charges may apply.

Reading an MMS message



When you receive an MMS message, the envelope icon is displayed at the top of the main screen:

1 Press , *Read* to display the new message directly from the main screen.

If you have received more than one message, the *Inbox* is displayed. Scroll to the message using the  and  keys and then press , *Select*.

To read old messages, go to the Inbox:

 Find it:  *Menu* ▶ *Messages* ▶ *Inbox*

Scroll to the message using the  and  keys and then press , *Select*.

2 The message is now downloaded to your phone and the message information is displayed (*From*, *Date*, etc.). To view the message, press , *Play*.

3 An MMS message consists of slides or pages. Each slide of the message is now displayed, including any pictures and sounds.



Tip: To stop playing a message, press , *Stop*.

Once all slides have been displayed, you can press , *Options* to access the message options listed below:

Select this To

- | | |
|--|--|
| <i>Delete</i> | Remove the message. |
| <i>Reply</i> | Send an MMS message to the sender. |
| <i>Reply to all</i> | Send an MMS message to the sender and all recipients. |
|  Note: | Additional costs may be incurred by selecting more than one recipient. Check with your network service provider for details. |
| <i>Play</i> | Play the message. |

Select this To

Call	Call the sender. Alternatively if there is a number in the message, highlight it and select this option to call the number.
Save no.	Add the sender's phone number to your contacts list.
Next slide	Go to the next slide.
Previous slide	Go to the previous slide.
Save picture	Save a picture which appears in the incoming message. The picture is stored in your Pictures list. See the Pictures section on Page 50 for more details.  Note: This option is only displayed if a picture is included in the message and you are allowed to save it.
Save sound	Save a sound or ringtone which is in the incoming message. The sound is stored in your Sounds list. See the Sounds section on Page 51 for more details.  Note: This option is only displayed if a sound or ringtone is included in the message and you are allowed to save it.
Close	Close the message.
Forward	Send the message to someone else.  Note: You may be prevented from sending items that are copy protected.

Sending an MMS message**▶ To send an MMS message from Messages**

 Find it:  **Menu** ▶ **Messages** ▶ **Create MMS**

1 An MMS message consists of slides or pages. When you start a new message, you will be on the first slide.

Write your message using the numeric keypad. See the *Entering text, numbers and symbols* section on Page 10 for details of entering text.

As you add more text and multimedia items, you will add more slides - see below.

 **Note:** You can only have one picture and one sound per slide. If you add another picture or sound, a new slide will be created and the item added.





2 Press **Options**  to display the following:











Select this To

Add picture *	Insert a picture, stored in the phone, into the message.
Add sound *	Insert a sound, stored in the phone, into the message.
Text colour	Select the text colour for all slides.
Remove object	Remove the highlighted object from the slide.
Add slide	Add a new slide to the message.
Delete slide	Delete the current slide.
Next slide	Go to the next slide.
Previous slide	Go to the previous slide.
Save	Save the current message to your Drafts folder.
Save as template	Save the current message to your Templates folder.
Preview	Preview the MMS message.
Slide timing	Set a timing for this slide. This defines how long the slide will be displayed for when the message is received.
Background colour	Select the background colour for all slides.
Exit	Exit the current message without saving the message.



 *** Note:** You may be prevented from sending items that are copy protected.

As you add text, multimedia items and slides, the size of the message can be checked using the counter in the top right of the screen. This displays the size of the message in KB (Kilo Bytes) and the slide information (e.g. 1/2 denotes slide 1 of 2).

- ➔ **Note:** The maximum message size supported by the P600 phone is 100KB. However, this may be limited further by your network. Contact your network service provider for details.
- 🔗 **Tip:** You can remove multimedia items from the message by simply highlighting the item and pressing .
- 3 When you have finished your message, press , **Send**. The message sending options are displayed.
- ➔ **Note:** You can save messages you send to others in your **Sent** folder (if you have sufficient memory remaining). See the **MMS settings** section on Page 23 for details.
- 4 With the **To:** field highlighted, press , **Select**. Enter the phone number or Email address of the person you want to send the message to, using the numeric keypad. If the person's details are stored in your contacts list, press , **Contacts** and select a name and number or Email address from your contacts list. You can enter up to 20 numbers or Email addresses, by repeatedly selecting the **To:** field and then the **Add recipient** option.
- ➔ **Note:** If you reply to a message, you do not have to re-enter the number. This is done automatically.
- ➔ **Note:** Additional costs may be incurred by selecting more than one recipient. Check with your network service provider for details.

- 5 If you would like to copy the message to someone, press the down  key to move to the **Cc:** field and press , **Select**. Enter the details for the person you would like to copy the message to. Again, you can enter up to 20 numbers and Email addresses.
- 6 If you want to enter a subject for the message, press the down  key to move to the **Subject:** field and press , **Select**. Enter a subject for the message.
- 7 If you would like to be notified when your message has been read, press the down  key to move to the **Read report** field and press , **Select**. Scroll to the **On** option and press , **Select**.
- 8 If you would like to be notified when your message has been sent, press the down  key to move to the **Delivery report** field and press , **Select**. Scroll to the **On** option and press , **Select**.
- 9 When your message is complete, press , **Send** to send the message.

▶ To send an MMS message from contacts

- 1 Press , **Contacts** from the main screen, and select the **Search** option to display your contacts list.
- 2 Scroll to a contact, press , **Options** and select **Send message** then **Create MMS**.
- 3 Enter your message and send it in the normal way. The favourite number for the contact will be used for the message - you can change this if you need to.

▶ To send an MMS message from the main screen

- 1 Enter the phone number you want to send an MMS message to.
- 2 Press , **Options** and select **Send message** then **Create MMS**.

▶ **To send an MMS message from the calls list**

 Find it:  **Contacts** ▶ **Calls list**

1 Scroll to an entry in the calls list, press , **Options** and select **Send message** then **Create MMS**.

▶ **To take a photo and send it in an MMS message**

 Find it:  ▶  **Capture** ▶  **Send**

1 Enter your message and send it in the normal way.

▶ **To send an MMS message from the pictures and sounds lists**

 Find it:  **Menu** ▶ **Pictures/Sounds**

- 1 Select the **Pictures** or **Sounds** option to display the pictures or sounds list.
- 2 Scroll to the item you want to send, press , **Options** and select the **Send as MMS** option.

Using templates

To save time, you can generate a text message or MMS message from a template - a standard message from your phone's memory.

▶ **To create a message using a template**

 Find it:  **Menu** ▶ **Messages** ▶ **Templates**

- 1 The list of current templates is displayed. Scroll to the template you want to use and press , **Select**.
- 2 A new SMS or MMS message is created using the template. You can now change the message, save it and/or send it in the normal way.

▶ **To create an MMS template**

 Find it:  **Menu** ▶ **Messages** ▶ **Create MMS**

1 Enter the message details in the normal way.

2 When you have finished your template, press , **Options** and select the **Save as template** option.

Sorting and deleting messages

Each folder in the **Messages** menu allows you to sort and delete messages.

▶ **To sort messages**

1 Whilst in a folder, press , **Options** and select the **Sort** option.

2 Select one of the following:

By date

Sort the messages in date order (most recent first).

By type

Sort the messages in type order (MMS then SMS).



By sender

Sort the messages in alphabetical order of sender. This option is only available in the **Inbox** folder.

By receiver

Sort the messages in alphabetical order of receiver. This option is only available in the **Sent** folder.

▶ **To delete messages**

1 Whilst in a message or a folder, press , , **Options** and select one of the following delete options:

Delete

Delete this message only.





Delete all

Delete all messages from the folder.

Calling your voice mail

You can access your voice mailbox by doing one of the following:

 **Note:** Voice mail is a network service. You may have to subscribe to this service and it may not be available when roaming. Check with your network service provider for details.

- ◆ When you have a new message in your voice mailbox, your phone displays either the voice mail icon  in the main screen or a text message sent from the network. This depends on your network service provider. From the main screen press , **Call** (if available) to call your voice mailbox or  to cancel the message.
- ◆ From the main screen press and hold .
- ◆ Select the **Voice mail** option from the **Messages** menu.

If the phone asks for the voice mailbox number, enter it and press , **Call**. The number can be obtained from your network service provider.

To enter/change a voice mailbox number, see the **Advanced settings** section on Page 55.

SMS and MMS settings

SMS settings

-  Find it:  **Menu** ▶ **Messages** ▶ **Settings** ▶ **SMS settings**

Select this To

- | | |
|----------------------|---|
| Status report | Set whether or not you want to be informed when your correspondent has received your text message. |
| Save sent | Save all sent text messages to the Sent folder (On). |
| Centre number | Enter or change the service centre number for text messaging. |
| Characters | Choose whether you want to enter text in GSM (Latin characters) or Unicode (Non Latin characters) mode. Unicode characters take up more room on your phone so the length of a standard text message is restricted to half the usual number of characters. |
-

MMS settings

-  Find it:  **Menu** ▶ **Messages** ▶ **Settings** ▶ **MMS settings**

This menu provides settings for MMS messaging. These settings may have already been configured on your phone by your network service provider. If your phone is not configured already, the fastest and easiest way to do this is to visit:

<http://www.sendo.com/config>

to automatically configure your settings. The Sendo Easy Configurator sends an SMS message to your phone containing the settings you require. Alternatively, you can ask your network service provider to send you this information (if available).

MMS settings are grouped into profiles. A profile is a collection of settings for MMS messaging. You can create up to 5 MMS profiles on your phone.

This menu provides the following settings:

- ◆ **Note:** Some of these settings may not be required for your network. Contact your network service provider for details.

Select profile

Select the current profile.

Rename profile

Rename the current profile.

Sending

Allows you to set the MMS sending options:

Select this To

- | | |
|------------------------|--|
| Validity period | Set a maximum amount of time allowed for a message to reach a recipient. If the recipient cannot be reached within the time, the message is removed from the message service centre. |
| Read report | Select whether or not you want to be notified when your messages have been read. |
-

Select this	To
<i>Delivery report</i>	Select whether or not you want to be notified when your messages have been sent.
<i>Priority</i>	Select the priority setting for MMS messages.
<i>Show number</i>	Select whether or not you want to show your phone number (Yes) or hide it (No) when sending MMS messages.
<i>Save sent</i>	Select whether or not you want to automatically save sent messages to your <i>Sent</i> folder.
<i>Slide timing</i>	Set the default slide timing for MMS messages you send.
<i>Delivery time</i>	Set the default time before MMS messages are sent. Note that a message is always sent to the service centre immediately and is then delayed for the specified time before being sent on to the recipient.

Retrieval mode

Allows you to set the MMS receiving options:

Select this	To
<i>Home network</i>	Select how you want to retrieve MMS messages when you're on your home network: <i>Automatic</i> - Always retrieve messages immediately. <i>Always ask</i> - Always ask before retrieving messages.
<i>Roaming network</i>	Select how you want to retrieve MMS messages when you're on a roaming network: <i>Automatic</i> - Always retrieve messages immediately. <i>Always ask</i> - Always ask before retrieving messages. <i>Restricted</i> - Never retrieve messages (whilst roaming) until you return to your home network.

Select this	To
<i>Send read report</i>	Select whether you want to <i>Always</i> send read reports when you read MMS messages, or only <i>On request</i> or <i>Never</i> .
<i>Del. Rep. allowed</i>	Select whether you want to send delivery reports (Yes) when you receive MMS messages.

MMSC

Enter the web address (URL) of your MMS message centre.

Network

Allows you to set the MMS network options:

Select this	To
<i>Connection type</i>	Select the MMS connection type: <i>Temporary</i> , or <i>Permanent</i> .
<i>Data account</i>	Select the data account to use for MMS messaging. See the <i>Data accounts</i> section on Page 56 for details on data accounts.  Note: The data account used must be an MMS data account.

WAP gateway

Set the IP address of the WAP gateway used for MMS messaging.

 **Note:** An IP address is made up of 4 groups of numbers (maximum of 3 numbers per group). If any of the groups only has 1 or 2 numbers then you must enter a zero, or zeros, ahead of the existing numbers to make the group up to 3. You can get the IP address from your network service provider.

<i>Login</i>	Enter the gateway login name.
<i>Password</i>	Enter the gateway password.
<i>Secure port</i>	Enter the gateway port number for secure connections.

Your P600 phone is provided with a WAP browser, giving you access to internet sites with WAP content.

Internet settings

Before you can use your WAP browser, you must have set up your phone for internet access. These settings may have already been configured on your phone by your network service provider. Simply try connecting to the internet or check with your network service provider for details.

If your phone is not configured already, the fastest and easiest way to do this is to visit:

<http://www.sendo.com/config>

to automatically configure your settings. The Sendo Easy Configurator sends an SMS message to your phone containing the settings you require. Alternatively, you can ask your network service provider to send you this information (if available).

See the *Settings* section on Page 27 for details of how to configure your phone's internet connection settings.

- **Note:** Your network service provider can tell you what internet services are available, and what charges may apply.

Internet menu

📎 Find it:  *Menu* ▶ *Internet*

Home

Go to your homepage. Note that the title of this option will reflect the title of your homepage.

- **Note:** If there is no default homepage defined on your phone, see the *Setting your homepage* section on Page 26.

Bookmarks

Store the addresses of your favourite websites, so that you can access them quickly.

Recent Pages

Display a list of recently visited pages. Press , *Go to* to go to the highlighted page.

Enter Address

Enter a WAP address (URL) to go to.

Resume

Resume the previous internet connection.



Settings

Enter all the information you need to connect to the internet. See the *Settings* section on Page 27 for details.

Connecting to an internet page

📎 Find it:  *Menu* ▶ *Internet*

To begin browsing the internet, select one of the following options from the *Internet* menu:

- ◆ Select *Home*.
- ◆ Select *Bookmarks*, scroll to a bookmark and press , *Select*.
- ◆ Select *Recent Pages*, scroll to a page and press , *OK*.
- ◆ Select *Enter Address*, enter a WAP site address (URL) and press , *OK*.

- ❓ **Tip:** Once you press *Select* or *OK*, if you press and hold , the internet connection will be cancelled.



Downloading

You can download compatible pictures and ringtones to your phone as well as Java games and applications. See the *Pictures/Sounds* chapter on Page 50 for details of downloading pictures and ringtones and see the *Java* chapter on Page 48 for details of downloading Java games and applications.

In browser options

While you are using the internet, press , **Options** to access the menu options listed below:

Select this To

Page options	This option on the menu will change depending on the website you are viewing. For example, if there is a search option on the page, this item in the menu could be Search .
Homepage	Return you to the homepage. Note that the title of this option will reflect the title of your homepage.
Back	Move back to the last screen visited.
Forward	Move forward to a screen you have previously visited in the session.
Recent Pages	Display a list of recently visited pages. Press  , Go to to go to the highlighted page.
Refresh	Reload the page you are currently using. Any updates to the page are displayed.
Bookmarks	Display your bookmarks. Press  , Select to go to the highlighted bookmark.
Enter Address	Enter a new address (URL) to display.
Empty cache	Clear the phone memory of recently accessed WAP pages.
Save as homepage	Save the URL of the current page as your homepage.
Exit	Close the WAP session and returns to the main menu. Tip: You can also press and hold  to close a WAP session.
Settings	Go to the internet Settings menu. See the internet Settings section on Page 27 for details.
Save as	Download the highlighted object to your phone. You can change the filename if you wish.

Setting your homepage

Find it:  **Menu** ▶ **Internet** ▶ **Settings** ▶ **Edit homepage**

To specify your homepage, enter the URL (WAP address) and press , **OK**. The homepage is saved.



Note: Some network service providers do not allow users to specify their own homepage. Contact your service provider for more details.

Bookmarks



Use the **Bookmarks** menu to save WAP addresses, giving you quick access to your favourite sites.

▶ To create a bookmark from the Internet menu

Find it:  **Menu** ▶ **Internet** ▶ **Bookmarks** ▶ **Add Bookmark**





1 Enter the **Title** and WAP **Address**, and press , **OK** (use the  and  keys to scroll between **Title** and **Address**). The bookmark title now appears in your list.

▶ To create a bookmark in the browser

- 1 While you are using the internet, press , **Options** and select **Bookmarks**.
- 2 Scroll to the **Add Bookmark** option and press , **Select**. This will add the current WAP page address to your list.



▶ To edit a bookmark

Find it:  **Menu** ▶ **Internet** ▶ **Bookmarks**

- 1 Scroll to the bookmark to edit and press , **Options**. Scroll to the **Edit** option and press , **Select**.
- 2 Change the title or URL and then press , **OK** (use the  and  keys to scroll between **Title** and **Address**). The bookmark is updated.

▶ To delete a bookmark

Find it:  *Menu* ▶ *Internet* ▶ *Bookmarks*

- 1 Scroll to the bookmark to delete and press , *Options*. Scroll to the *Delete* option and press , *Select*. Press , *OK* to confirm. The bookmark is deleted.

Settings

Find it:  *Menu* ▶ *Internet* ▶ *Settings*

This menu provides settings for internet access. These settings may have already been configured on your phone by your network service provider. If your phone is not configured already, the fastest and easiest way to do this is to visit:

<http://www.sendo.com/config>

to automatically configure your settings. The Sendo Easy Configurator sends an SMS message to your phone containing the settings you require. Alternatively, you can ask your network service provider to send you this information (if available).

Internet settings are grouped into profiles. A profile is a collection of settings for internet access. You can create up to 5 internet profiles on your phone.

This menu provides the following settings:

- **Note:** Some of these settings may not be required for your network. Also, certain settings may be locked by your network service provider. Contact your service provider for details.

Edit homepage

Enter the URL of your homepage.

Select Profile

Select the current profile. Note that a profile must be selected before any internet settings can be selected.

Connection

Allows you to select the connection options:

Select this To

Data Account Select the data account to use for internet access. See the *Data accounts* section on Page 56 for details on data accounts.

- **Note:** The data account used must be a WAP data account.

Connection type Select the WAP connection type: *Temporary* or *Permanent*.

Proxy Address Set the IP address of the proxy server used for internet access.

- **Note:** An IP address is made up of 4 groups of numbers (maximum of 3 numbers per group). If any of the groups only has 1 or 2 numbers then you must enter a zero, or zeros, ahead of the existing numbers to make the group up to 3.

Proxy Port Enter the proxy server port number for WAP connections. Typically, this will be 9201.

Proxy Secure Port Enter the proxy server port number for secure WAP connections. Typically, this will be 9203.

Proxy Username Enter the username to use with the proxy server.

Proxy Password Enter the password for the proxy server.

Security This option provides access to the advanced WAP security features. It is strongly recommended that you only change these settings in conjunction with your network service provider. The options are listed below for information only.
Certificates, Change Auth. Pin, Change SignText, Session Info, Current Certificat., Contracts

Browser Options

Select whether or not to *Show Images* in the WAP browser.

Rename Profile

Rename the current profile.

Cache

Allows you to select the cache options:

Select this To

Cache Mode Select whether or not the WAP browser will cache (store) internet pages on your phone. This can provide faster access to WAP sites when you revisit the same pages. However, caching does use up memory on your phone.

Clear Cache Clear the cache of recently accessed WAP pages.

Cookies

Enable or disable cookies using the **Enable Cookies** option, or clear all internet cookies on your phone using the **Clear Cookies** option.

Cookies are small text files used by some web sites to store information, about you and your preferences, on your phone. This allows revisited sites to provide you with a personal web page, for example. Only the information that you provide can be stored in a cookie. For example, a site cannot determine your Email address unless you choose to provide it. Allowing a web site to create a cookie does not give that site or any other site access to anything else on your phone, and only the site that created the cookie can read it. However, although cookies should not present a significant security risk, you may not want to have this information used or stored.

Clear Recent Pages

Delete all links to recently visited pages.

7 Personalise your phone

This chapter summarises the main features that can be used to personalise your P600 phone. These include ringtones, sounds, themes, screensavers, backgrounds and of course, the covers.

Ringtones

You can set a main ringtone and set individual ringtones for entries in your contacts list.





▶ To set a main ringtone

 Find it:  **Menu** ▶ **Settings** ▶ **Sounds**

- 1 Select the **Ringer** option and scroll through the list of ringtones. As you pause on each ringtone, it will be played.
- 2 Press , **Select** to select the ringtone.

▶ To set a ringtone for a contact

 Find it:  **Menu** ▶ **Pictures/Sounds**

- 1 Select the **Sounds** option and scroll through the list of ringtones:
 - ◆ Press , **Play** to play the ringtone and  to return to the ringtone list.
 - ◆ Press , **Options** and select the **Attach** option to select the ringtone.
- 2 Scroll through the list of contacts and press , **Select** to set the ringtone. If the contact has more than one number (**Mobile**, **Work**, **Home**), scroll to the number you want and press , **Select**.

The ringtone will only be played when a call is received from the individual number (as long as the caller's number can be seen by your phone - for example, not withheld).

Sounds

You can set the sounds played for actions and events on your phone.

▶ To set sounds

 Find it:  **Menu** ▶ **Settings** ▶ **Sounds**

- 1 Select the **Key tones** option. This option allows you to set the type of keypad tones

that you would like to hear when pressing the keys:

Off

No sound emitted on a key press.

On

Short, low volume tone.

DTMF

These are standard tones, as used in touch tone phones. Each number has its own specific tone.

- 2 Select the **On/Off melody** option. The phone can play a melody whenever you switch it on or off. Select this option to switch this feature **On** or **Off**.
- 3 Select the **Events** option. This option allows you to set the sounds that you would like to hear for certain events:

New message

The phone can play a sound when a new message is received (SMS, EMS, MMS or voicemail). Select this option to switch this feature **On** or **Off**, and to **Change** the sound played.

New broadcast

The phone can play a sound when a new broadcast message is received. Select this option to switch this feature **On** or **Off**.

Low battery





The phone can play a sound when the battery is low. Select this option to switch this feature **On** or **Off**.

Volume and vibrate

You can change the volume of ringtones and sounds, and set the vibrate feature.

▶ To set the volume and vibrate feature

 Find it:  **Menu** ▶ **Settings** ▶ **Sounds**

- 1 Select the **Volume** option to change the volume setting for ringtones and sounds. Use the  and  keys to increase and decrease the volume level.
-  **Tip:** Press the  key with the volume set to maximum, and an arrow will appear.

With this setting, ringtones are played with a steadily increasing volume.

- 2 Select the **Vibrator** option to set the vibrate feature for incoming calls and event/alert sounds:

Off

Deactivates the vibrate feature.



On

Sets the phone to vibrate for an incoming call or message.

Vibrate then ring

Sets the phone to vibrate for a few seconds before the phone starts to ring.

- ➡ **Note:** None of the vibrate settings affects any of the sounds settings.

- 3 To enter/exit silent mode, you can press  then  from the main screen. The silent symbol,  is displayed on the main screen when the phone is in silent mode.

- ➡ **Note:** If the vibrate function is set to on, the phone will still vibrate whilst in silent mode.

- ➡ **Note:** If the phone is switched off, silent mode is cancelled. This helps to ensure no calls are missed.

Display

You can change the way your phone displays information as well as the theme (colour scheme), wallpaper and screensaver.

▶ To set your phone's displays

- 🔍 Find it:  **Menu** ▶ **Settings** ▶ **Display**

- 1 Select from the following options to choose your display settings:

Backlight

You can specify default times for the backlight on the phone.

- ➡ **Note:** The backlight timer settings do not affect the backlight settings for WAP and games.

LCD contrast

Use the  and  keys to set the contrast of the screen.

Themes



Choose the colour scheme to be used throughout all your phone's menus.

Wallpaper

Turn this feature **On** or **Off** and assign a picture from the phone's memory (using **Select picture**). The wallpaper is displayed in the main screen. The **Format** option lets you choose how to display the image: **Full screen** (resize the image to fill the screen), **Centre** (centre the image on the screen), **Mosaic** (tile a small image to fill the screen).

Screensaver

Turn this feature **On** or **Off**, set the delay before it becomes active and assign a screensaver picture or animation from the phone's memory (using **Select picture**). The screensaver settings do not affect power save mode.

- ➡ **Note:** When the screensaver is displayed, press any key to return to normal display (or press , **Unlock** then  if the keypad is locked).

Animations

Select this option to turn main menu animations **On** or **Off**.

Covers

You can change the front cover and battery cover of your phone as described below. Check out the Sendo shop for compatible covers:

www.sendo.com/shop

- ➡ **Note:** The cover surrounding the camera lens and mirror cannot be changed.

Please observe the following warnings when removing and replacing covers:

- ⚠ **Warning:** The covers are made of plastic and can be broken. Take care when

removing or replacing any part of your phone.

- ⚠ Warning:** When changing covers, you are removing some of the phone's outer protection. Therefore, take extra care with your phone and avoid exposure to dirt, dust, liquids (including condensation) and static electricity. Replace all covers as quickly as possible.

- ⚠ Warning:** Do not charge the battery with either of the phone covers removed.

▶ To change your battery cover

- 1** To remove the battery cover, press down on the area at the top of the back cover, slide the cover down and lift off.

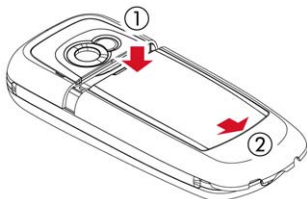

- 2** To replace the battery cover, place the cover onto the back of the phone and slide the cover into place, making sure the tab at the top of the cover clicks into place.

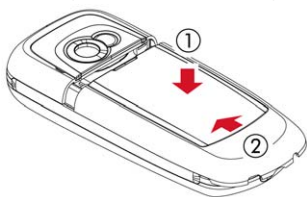

▶ To change your front cover

- 1** Remove the battery cover as described above.
- 2** Remove the battery - press down on the tab at the centre of the bottom edge of the battery and lift out.

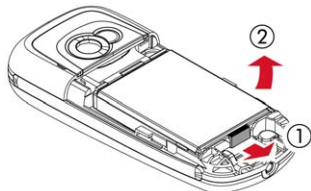

- 3** Pull on the two tabs near the bottom of the phone at the same time, and press down. The bottom of the cover should now stand clear of the phone slightly.

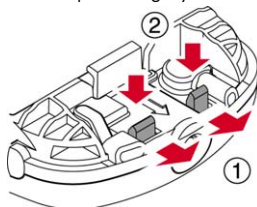

- 4** Gently but firmly pull the bottom of the cover away from the phone, as illustrated below.



- 5 Separate the front cover, keypad and phone and place the keypad into the new cover.



- Note:** If you want to clean the inside of your cover, use a clean, soft, dry cloth. You should carefully blow off any remaining dust before replacing the cover.

- 6 To replace the front cover, place the top of the cover onto the phone and then press the bottom of the cover and the phone together (making sure the two tabs at the bottom of the cover are aligned correctly with the holes on the phone - the cover should click into place).



- 7 Insert the battery into the phone, starting with the top edge first. Align the tabs on the edge of the battery with the tabs on the back of the phone. Make sure the gold-

coloured contacts of the battery are touching the contacts on the phone. Push down into place.

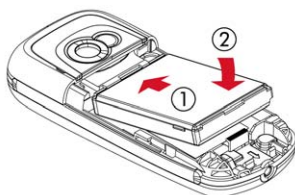

- 8 Replace the battery cover as described above.

Wrist/neck strap

You can attach a wrist strap or neck strap to your Sendo P600 phone.

First remove the battery cover as described in the Covers section above. Now insert the strap loop into the aperture at the bottom of the phone, as illustrated below (1). Push the strap loop over the small plastic hook (2) to secure the strap in place.

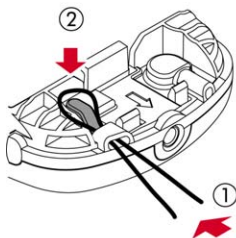



You can store up to 250 contacts in the contacts list on your phone, as well as set favourite numbers, attach pictures and ringtones and define speed dials. For each contact, you can save mobile, work and home numbers as well as an Email address.

- **Note:** For all contact phone numbers, you must include the city or area code and phone number. You may want to store all contact phone numbers in international format. That is, the international access code (+), the country code (without leading zeros), city or area code (some countries require the leading zeros to be omitted from the city/area code) and phone number. Press and hold  to enter a + symbol.

Phone contacts and SIM contacts

You can choose to store contacts to your phone or SIM card by default.

- **Note:** When you display your contacts list, all SIM and Phone contacts are listed. SIM contacts are identified by the SIM  icon.

To set your default, press , **Contacts** from the main screen and select the **Default** option:

Phone

This option will save new contacts to your phone by default. This allows you to save multiple numbers for a contact.

SIM

This option will save new contacts to your SIM card by default. You can only save one number per entry. However, if you change phones but keep the same SIM card, your contacts can be copied to the other phone.



- **Note:** The number of contacts you can store on your SIM will vary. Check with your network service provider.
- ❓ **Tip:** Whichever option you choose, you can copy contact information between

your phone and SIM. See the **Copying contacts** section on Page 36 for details.











Adding a contact



▶ To add a contact

- 📞 Find it:  **Contacts** ▶ **Add new**



- 1 You now enter the edit screen. Use the  and  keys to scroll between the fields and press , **Select** to edit each field as needed:

- **Note:** The information you can store for a contact depends on your **Default** settings. See the **Phone contacts** and **SIM contacts** section on Page 33 for details.

Field	Description
Name	For SIM and Phone contacts: Enter the name you wish to store for the contact, and press  , OK . Use the keypad as described in the Entering text, numbers and symbols section on Page 10, to enter the details.
Number 	For SIM contacts only: Enter the contact's phone number and press  , OK .
Mobile Number 	For Phone contacts only: Enter the contact's mobile phone number and press  , OK .
Work Number 	For Phone contacts only: Enter the contact's work phone number and press  , OK .
Home Number 	For Phone contacts only: Enter the contact's home phone number and press  , OK .
Email address 	For Phone contacts only: Enter the contact's Email address and press  , OK . Use the keypad as described in the Entering text, numbers and symbols section on Page 10, to enter the details.
	❓ Tip: You can send MMS messages to an Email address.

- ➔ **Note:** You must have a name and one number in order to save the contact.
- 2 When you have finished, press , **Save** to save the contact details.
- 3 For Phone contacts, you will be asked to select a favourite number for the contact. This number is then displayed first when calling the contact. Scroll to the number you want to select as the favourite, and press , **Select**.
- ➔ **Note:** You can store up to 250 favourite numbers but only 10 of these can be over 32 characters long.
- 4 The contact information is now stored.





▶ To add a contact from the main screen

- 1 From the main screen, enter the phone number you wish to store.
- 2 Press , **Options** and select **Save**.
- ➔ **Note:** The information you can store for a contact depends on your **Default** settings. See the *Phone contacts and SIM contacts* section on Page 33 for details.
- 3 For a Phone contact, select the type you want to associate with this number (mobile, work or home). Scroll to the type you want and press , **Save**.
- 4 Enter the name you want to store in the contacts list, and press , **OK**. Use the keypad as described in the *Entering text, numbers and symbols* section on Page 10, to enter the characters.
- 5 The contact information is now stored.

Speed dials

- ➔ **Note:** You can assign speed dials to SIM contacts but this information will not be stored in the SIM.

▶ To add a speed dial

- ➔ Find it:  **Contacts** ▶ **Search**
- 1 Type in the first letters of the name or scroll and find the one that you want.
- 2 Press and hold one of the keys  to  until the key number appears on the left of the screen, beside the name. This indicates that the speed dial is successfully assigned.
- ➔ **Note:** If the contact has more than one phone number stored, e.g. **Mobile**, **Work**, **Home**, the speed dial is linked to the favourite number.
- ➔ **Note:**  is normally reserved for voicemail.

▶ To remove a speed dial

- ➔ Find it:  **Contacts** ▶ **Search**
- 1 Type in the first letters of the name or scroll and find the one that you want.
- 2 Press and hold the number key already assigned to the name, until the key number is removed from the left of the screen, beside the name.

▶ To make a call using speed dial

- 1 From the main screen, press and hold the number key assigned to the contact you want to call.
- ➔ **Note:** If the contact has more than one phone number stored, e.g. **Mobile**, **Work**, **Home**, the favourite number is called.



Attaching pictures and ringtones

You can attach pictures and ringtones to your contacts. When you receive a call from the contact, the attached picture is displayed and the attached ringtone is played (as long as the caller's number can be seen by your phone - for example, not withheld).

- ➔ **Note:** You can attach pictures and ringtones to SIM contacts but this information will not be stored in the SIM.



▶ To attach a picture or ringtone

 Find it:  **Contacts** ▶ **Search**

- 1 Type in the first letters of the name or scroll and find the one that you want.
- 2 Press , **Options** and select the **Attach picture** option or **Attach sound** option as required.
- 3 Scroll through the displayed list and press , **Select** for the picture/ringtone you want. Note that if a picture/ringtone is already attached to the contact, this will be highlighted first - simply select another one if you want to change it.

▶ To unattach a picture or ringtone





 Find it:  **Contacts** ▶ **Search**



- 1 Type in the first letters of the name or scroll and find the one that you want.
 - 2 Press , **Options** and select the **Unattach picture** option or **Unattach sound** option as required.
 - 3 Press , **OK** to confirm the action.
-  **Tip:** You can unattach all pictures and/or all ringtones from the **Pictures/Sounds** menu. See the **Pictures/Sounds** chapter on Page 50 for details.

Edit contacts

▶ To edit contact details



 Find it:  **Contacts** ▶ **Search**

- 1 Type in the first letters of the name or scroll and find the one that you want.
- 2 Press , **Options** and select the **Edit** option.
- 3 You now enter the Edit screen. Simply scroll to an entry you want to change and press , **Change**.
- 4 Make the desired changes to the contact details and press , **OK** to accept the change or , **Back** to reject it.

- 5 Press , **Save** to save all the changes or , **Cancel** to cancel them and return to the contacts list.

▶ To change a favourite number

 Find it:  **Contacts** ▶ **Search**

- 1 Type in the first letters of the name or scroll and find the one that you want.
 - 2 Press , **Options** and select the **Favourite** option.
-  **Note:** Favourite numbers are only available for Phone contacts.
- 3 The current favourite is highlighted. Scroll to the number you want to be the favourite, and press , **Select**.

Contacts list options

When a name is highlighted in the contacts list, press , **Options** to display the menu options listed below:

Select this To

Send message	Send an SMS or MMS message directly to this contact.
Edit	Edit the details for this contact.
Details	View the details for this contact.
Attach picture	Attach a picture for this contact.
Attach sound	Attach a ringtone for this contact.
Unattach picture	Unattach the picture for this contact.
Unattach sound	Unattach the ringtone for this contact.
Copy to SIM/ Copy to phone	Copy your contact details from your SIM to your phone or from your phone to your SIM. See the Copying contacts section below for details.
Favourite	Select a favourite number for this contact (Phone contacts only).
Delete	Delete this contact.

Finding a contact

- **Note:** When you display your contacts list, all SIM and Phone contacts are listed. SIM contacts are identified by the SIM  icon.

▶ To find a contact

- 🔍 Find it:  **Contacts** ▶ **Search**

- 1 Type in the first letters of the name or scroll and find the one that you want.

You can call the contact directly from here or view the contacts list **Options** menu.

Copying contacts

You can copy contacts in one of two ways.

▶ To copy a single contact

- 🔍 Find it:  **Contacts** ▶ **Search**

- 1 Type in the first letters of the name or scroll and find the one that you want.

- 2 Press , **Options** and select the **Copy to SIM** or **Copy to phone** option as displayed.

▶ To copy all contacts

- 🔍 Find it:  **Contacts** ▶ **Copy contacts**

- 1 You will be asked to confirm the copy.

- **Note:** If you are storing your contacts on your SIM, you will copy all your Phone contacts (favourite numbers only) to your SIM. Similarly, if you are storing your contacts on your phone, you will copy all your SIM contacts to your phone. See the *Phone contacts and SIM contacts* section on Page 33 to view or change your settings.

Deleting contacts

You can delete contacts in one of two ways.

▶ To delete a single contact

- 🔍 Find it:  **Contacts** ▶ **Search**

- 1 Type in the first letters of the name or scroll and find the one that you want.

- 2 Press , **Options** and select the **Delete** option.

▶ To delete all contacts

- 🔍 Find it:  **Contacts** ▶ **Delete all**

- 1 You will be asked to confirm the deletion. Press , **Yes** to delete your contacts.

- **Note:** If you are storing your contacts to your SIM, only the SIM contacts are deleted. Similarly, if you are storing your contacts on your phone, only the Phone contacts are deleted. See the *Phone contacts and SIM contacts* section on Page 33 to view or change your settings.

Fixed names

- **Note:** This feature is only available if supported by your network service provider/SIM card. Contact your service provider for details.

This option in the main **Contacts** menu provides access to a separate set of contacts, protected by your PIN2 code. Calls and messages are restricted to the numbers in your fixed names contacts list.

This feature can be useful, for example, for parents who want to restrict calls and messages for their children, or for corporate use.

- **Note:** Emergency numbers and use of the WAP browser are NOT restricted by the fixed names feature.

▶ To use the fixed names feature

- 🔍 Find it:  **Contacts** ▶ **Fixed names**

- 1 Select **On** and enter your PIN2 code (see the *Your PIN2 code* section below) to activate the feature.

- 2 You will only have access to your fixed name contacts and you will only have access to a limited **Contacts** menu.

- 3 You can use the **Contacts** menu options in the same way as the normal contacts

feature. However, adding, changing and deleting contacts will require the PIN2 code.

- **Note:** All fixed name contacts are stored in your SIM only.

▶ To disable the fixed names feature

- 📞 Find it:  **Contacts** ▶ **Fixed names**
- 1 Select **Off** to deactivate the feature - you will be asked for your PIN2 code.
- 2 When you return to your normal contacts list, the fixed names contacts are available for use. However, deleting or changing these contacts will require the PIN2 code.

Your PIN2 code

Your PIN2 (Personal Identity Number) code is a code that you can use to protect your phone. If you enter the wrong PIN2 code three times, the PIN2 code is locked and you may be asked to enter a PUK2 (Personal Unlock Key) code.

- **Note:** The number of incorrect entries depends on your network service provider.

The PIN and PUK codes may be listed in the information that you received with your SIM card or they may only be available from your network service provider (these may be different for PIN and PIN2).

- **Note:** Sendo cannot provide your PIN or PUK codes.

Additional Contacts menu options

- 📞 Find it:  **Contacts**

The **Contacts** menu also provides the following options:

Calls list

Display the calls list. See the **Calls list** section below for details.

Memory

Display the number of contact entries in your phone and SIM (for example, 50/250 means you have used 50 of 250 possible entries).

Service numbers

Your network service provider may have pre-programmed some useful numbers into your SIM card. These numbers normally give access to special services. For more information contact your service provider.

- **Note:** This option is only displayed if your network service provider supports service numbers.

My number

Your own mobile phone number may be available through the **My number** option:

- ♦ If a number or name is listed here, select **Consult**, press , **Options** and select **Details** to display your phone number.
- ♦ If no number or name is listed here, provider, contact your network service provider with your SIM number and they will advise you accordingly. You can then select the **Add new** option from the **My number** menu to enter your mobile number.





Calls list

 Find it:  *Contacts* ▶ *Calls list*

The phone stores a list of your recent incoming, outgoing and missed calls.

The list stores up to 30 entries. If a number is stored in your contacts list, the contact name is displayed.



Type and Direction icons on the left of the screen indicate the type of number/contact and the direction of the call:

-  Mobile number
-  Work number
-  Home number
-  SIM contact
-  Unknown contact
- ▶ Incoming call from a number
- ◀ Outgoing call to a number
- ✕ Missed call from a number

For example,  ▶ indicates an incoming call from a work number stored in your contacts.

Making a call from the calls list

▶▶ Quick tip:  *Contacts* ▶ *Calls list* ▶  /  ▶  *Call*

Press , *Contacts* from the main screen, and select the *Calls list* option to display the calls list. Scroll and find the entry that you want and press , *Call* to dial.

Calls list options

When you have highlighted an entry in the calls list, press , *Options* to display the menu options listed below.

Select this	To
<i>Save no.</i>	Save the number to your contacts list.
<i>Send message</i>	Send a text message or MMS message directly to this entry.
<i>Details</i>	View the details for this entry.
<i>Delete</i>	Delete this entry.
<i>Delete all</i>	Delete all entries in the calls list.

This chapter explains how to use the phone's built-in digital camera, how to send photos that you have taken, and how to edit and manage your pictures.

➤ **Note:** Obey all local laws governing the recording of images.

The digital camera allows you to take pictures wherever and whenever you like. You can snap your friends, family, or even yourself. The camera is simple to use, and produces high-quality digital images in a choice of sizes.

Pictures are saved directly to the phone in JPEG format, where you can edit and send them as you please.

➤ **Note:** If you receive a call when you are using the camera, the Incoming Call screen is displayed. You can accept or reject the call as you would normally. If you accept the call, the camera screen is displayed again when the call ends. If you reject the call, the camera screen is redisplayed immediately.

Taking a photo

▶ To take a photo

▶▶ Quick tip:  ▶  *Capture*

1 Activate the camera by pressing the camera shortcut key, .

➤ **Note:** You can also activate the camera by selecting the *Camera* option from the main menu.

2 Use the screen as the viewfinder for your picture, and press , *Capture* to take the photo. The picture is displayed on the screen.

❓ **Tip:** To take a photo of yourself, turn the phone round so the camera lens is facing you. Look at the self-portrait mirror near the lens, and position your reflection in the centre of the mirror. When you take a

photo, your image will be aligned correctly.

3 To take further photos, press , *Options* and select *Resume* to re-activate the viewfinder, and repeat steps 2 and 3.

➤ **Note:** Your photos are automatically saved to the phone. If you do not want to save a picture, press , *Options* and select *Delete*.

▶ To take a photo using the timer

🔊 Find it:  ▶  *Options* ▶ *Timer*

1 Select *On* to activate the camera timer feature.

2 Use the screen as the viewfinder, and press , *Capture* to take the photo. A countdown timer is displayed at the bottom of the screen. When the counter reaches zero, the photo is taken.

➤ **Note:** The timer remains active for one photo only.

Sending a photo

Once you have taken a photo, you can send it to your friends straight away.

▶ To send a photo





▶▶ Quick tip:  ▶  *Capture* ▶  *Send*

1 Once you have taken a photo, press , *Send*.

2 A new MMS message screen is displayed with the photo inserted. Send your message in the normal way. For more information see the *MMS messages* section on Page 19.

Photo options

Before you take a photo (when the viewfinder is displayed), you can do the following:



Press this	To
 <i>Capture</i>	Take a photo.
	Zoom in.
	Zoom out.
	Scroll through the <i>Large, Medium, Small, Extra Small, Large Portrait</i> and <i>Small Portrait</i> photo size settings. See the <i>Camera options</i> section on Page 40 for details of these options.
 <i>Options</i>	Display the camera menu options. See the <i>Camera options</i> section on Page 40 for details.

After taking a photo, press  , *Options* to display the following options:

Select this	To
<i>Resume</i>	Save the photo and return to the viewfinder, ready to take another photo.
<i>Delete</i>	Delete the photo.
<i>Rename</i>	Rename the photo.
<i>Pictures</i>	Go to the <i>Pictures</i> list where you can manage your photos. See the <i>Pictures</i> section on Page 50 for details.
<i>Send</i>	Create a new MMS message using this photo.
<i>Set as Wallpaper</i>	Set the photo as your wallpaper in the main screen.
<i>Set as ContactID</i>	Assign the photo to a contact in your contacts list.
<i>Edit</i>	<i>Rotate, Resize</i> or <i>Crop</i> the photo. See the <i>Editing your photos</i> section on Page 41 for details.
<i>Exit</i>	Exit the camera feature.

Camera options

 Find it:   *Options*

Select this	To
<i>Resolution</i>	Choose the photo size: <i>Large</i> - 640 x 480 pixels. <i>Medium</i> - 320 x 240 pixels. <i>Small</i> - 160 x 120 pixels. <i>Extra Small</i> - 128 x 96 pixels. <i>Large Portrait</i> - produces a portrait image (240 x 320 pixels). <i>Small Portrait</i> - produces a smaller portrait image (120 x 160 pixels). Portrait pictures can be useful for assigning to contacts.
<i>White balance</i>	Choose the light setting: <i>Automatic</i> - lets the camera automatically adjust to the light conditions. <i>Indoor</i> - produces slightly lighter images, ideal for indoor use. <i>Outdoor</i> - produces slightly darker images, ideal for outdoor use.
<i>Sharpness</i>	Set the photo sharpness. Press  to make the photos sharper and press  to make the photos softer.
<i>Timer</i>	Turn the timer feature <i>On</i> or <i>Off</i> . When you take a photo with the timer set to <i>On</i> , a countdown timer is displayed at the bottom of the screen. When the counter reaches zero, the photo is taken. This setting will only be used for the next photo.
<i>Picture effect</i>	Select a picture effect: <i>None</i> - no effect. <i>Black and White</i> - produces black and white photos. <i>Sepia</i> - produces photos with a brown tinge. This gives the photo an aged look. <i>Negative</i> - produces photos that look like a film negative. This setting will only be used for the next photo.

Select this To

Picture quality	Choose the photo quality: Fine - produces the best quality images, but consumes the most memory. Standard - produces images of slightly lower quality, but uses less memory so you can store more of them.
Multishot	Configure the multishot feature. You can turn this feature Off or select from 3 Shots or 5 Shots . When you take a photo with multishot on, 3 or 5 photos are taken consecutively.
Night mode	Turn this feature On or Off . Use Night mode to take a picture when lighting conditions are poor, and a longer exposure time is needed.
Shutter sound	Select a shutter sound from the list displayed.
Pictures	Go to the Pictures list where you can manage your photos. See the Pictures section on Page 50 for details.

Note: When viewing pictures taken in Large or Medium modes on your phone, the images will be scaled to fit the screen. This means that they will appear less detailed than when viewed on a higher resolution screen, such as a personal computer.

Memory

Photos use up phone memory. The better the resolution and quality, the more memory a picture will use.

The approximate number of pictures you can take with the available memory and the chosen resolution and quality settings, is displayed at the top right of the screen in the viewfinder.

Timeout

To save the phone's battery, the camera will automatically switch itself off after approximately 60 seconds if you have not pressed any keys. To re-activate the camera, press .

Editing your photos

Once you have taken a photo, press , **Options** and select the **Edit** option. You can rotate, resize or crop your photo:

Rotate



Rotate the image by **90 degrees clockwise** or **90 degrees anti-clockwise**.

Resize

Automatically scale the photo to fit on the display (128 x 96 pixels).

Crop

Crop the photo size to 128 x 128 pixels. Use the navigation keys to move the crop area around the photo. Press , **Ok** when you have finished.

When you have finished editing the photo, press , **Save** to save the photo or , **Delete** to discard it. The original photo will not be overwritten.

10 Games

The P600 comes with some great games for you to play:

- ◆ **Funny Farmer** - Build and manage your own virtual farm and even play against other gamers using a remote account. See the *Funny Farmer* section below.
 - ◆ **Solitaire** - The classic kill-time card game. See the *Solitaire* section on Page 44.
 - ◆ **Sumito** - Quick thinking, puzzle action. See the *Sumito* section on Page 44.
 - ◆ **Tenpin** - Score the perfect 300 in this classic tenpin bowling game. See the *Tenpin* section on Page 45.
 - ◆ **Splat** - Stop the moles from digging up your garden. Fast paced, hard hitting action. See the *Splat* section on Page 45.
- ❏ **Note:** The actual games supplied with your phone is dependent on your network service provider. Check the *Games/Applications* menu to see what games are listed.

You can download other Java games to your phone directly from the Internet. See the *Java* chapter on Page 48 for details of how to install and remove games and applications on your phone.

Funny Farmer



The object of the game is to build a virtual farm where you're the farmer. You can grow crops, rear livestock and sell your produce at the local shop. The more care you take of the

farm, the more money you can make, and the bigger and better the farm can become. Your ultimate aim is to win all 8 farming trophies available.

▶ To start a game of Funny Farmer

- Find it: **Menu** ▶ *Games/Applications*
- 1 Scroll to the *Funny Farmer* game and press , **Launch**.
 - 2 Scroll to **New game** to start a new game or **Continue** to continue a previously saved game, and press , **Ok**.

▶ To play Funny Farmer

When the game begins you have a small amount of money available. Use this cash to buy any seeds you can afford at the shop. You must plant the seeds and water them in order to grow produce which you can sell back to the shop. As you sell the produce and make more money you will be able to afford more seeds, chickens, cows and even add extensions to your farm.

- ❓ **Tip:** You can save the game at any time and return to it later by pressing , **Options** and selecting **Save and exit**.
- ◆ Use the keypad to move the farmer up , down , left and right .
 - ◆ Press to perform an action. For example, if you are standing next to a crop when you press , the crop is watered.
 - ◆ To end the day, use the keypad to take the farmer to the bedroom, face the bed and then press . If you don't do this, the day ends when the clock reaches 22:00.
 - ◆ Press , **Options** to exit the game. You can choose whether you want to save your current game or not.
 - ◆ Press , **Items** to check your full inventory and current status.
 - ◆ Press at any time for Help.
 - ◆ There are some occasions when pressing results in a choice. For example, when you are in the shop you can either buy or sell. You can also choose what you want to buy or sell, and in what quantity. Use the up and down keys to make

your selections and press , **Ok** to confirm.

- ◆ In a shop, press the  key to scroll a name that does not display fully on the screen.

Funny Farmer options

In the main game screen, press , **Options** to display the following list of options:

Services

Account details - Display your username and password if you have set up a remote account.

Upload status - Upload the current game status to your remote account.

Challenge details - Display the current challenge details (if you are taking part in a challenge).

Save and Exit

Save the current game and exit Funny Farmer.

Exit



Exit Funny Farmer without saving the game.

Remote Account

Funny Farmer allows you to play against other gamers using a remote account. Once you have set up an account, you can rank your Funny Farmer games against other players and play challenges.

- ◆ **Note:** Remote accounts and details of the facilities and costs is dependent on your network service provider. Contact your service provider for further information.

▶ To set up a remote account

- 1 In the main game screen, press , **Options** and select **Services** then **Upload status**.
- 2 Press , **Ok** and enter a username.
- 3 Press , **Ok** and you will then be prompted to select a connection profile.

Your username is sent to the Funny Farmer registration server, which will verify that the

name is unique and valid. If the username passes these checks an account will be created for you. If not, an error message is sent back, prompting you to retry.

Upon successful registration, your username and password are sent back to the game. You can view your username and password by selecting the **Account details** option from the **Services** menu.

▶ To rank your performance

- 1 In the main game screen, press , **Options** and select **Services** then **Upload status**.

The entire game status (of the current game) is uploaded to the game server. You will then receive a high score based on your game progress and your current and previous ranking compared to other players.

▶ To start a new challenge

- 1 Select the **Start new challenge** option when you start Funny Farmer.
- 2 A list of currently available challenges is sent to the game. Challenges arrive in the form of the challenge name and description.
- 3 Scroll to the challenge you wish to play and press , **Ok**.

Once a challenge is accepted a new game starts and a separate saved game is created. This can be saved without overwriting the main game. This way, you can switch between the main game and challenge game without affecting either.

The challenge details can be recalled by selecting the **Challenge details** option from the **Services** menu.

- ◆ **Note:** You can only take part in one challenge at a time.
- 4 Select the **Upload game status** option from the **Services** menu to update the game server with your current challenge status.

The server will then check to see if you have met the challenge criteria.







Solitaire



From the *Games/Applications* menu, scroll to the *Solitaire* game and press , *Launch*. To start a new game, scroll to *NEW GAME* and press .

The object of the game is to use all the cards in the deck to build up the four suit stacks in ascending order, beginning with the aces.

▶ To play Solitaire

- ◆ Each card stack has a keypad character next to it. To move a card simply press the character on the keypad to select the card you want to move, then press the character of the stack you want to move it to. If the card cannot be moved then it will stay where it is. For example, to move an ace card from the deck to the suit stack marked 8, press  to select the ace and then  to move it to the suit stack.
- ◆ Press  to cancel a card selection.
- ◆ When you have moved all the cards you can, press  to turn over the next set of cards on the deck.
- ◆ The game can be paused by pressing  or . Once paused, you can *RESUME*, start a *NEW GAME* or *EXIT* - press  to confirm your choice.

▶ Rules of the game

- ◆ You can build column stacks and suit stacks:
Column Stacks - Cards are stacked in descending order, alternating between red cards and black cards. For example, you can move the five of diamonds to the six of spades. You use the column stacks to free

up cards that you need to build the suit stacks.

Suit Stacks - Cards are stacked in ascending order, beginning with aces. For example, you can move the two of diamonds to the ace of diamonds.

- ◆ The top card on the deck (facing up) is the only card from the deck that can be moved.
- ◆ You can move a card from the deck to a column stack or suit stack.
- ◆ You can move a card from a column stack to a suit stack or vice versa.
- ◆ You can also move a card (or set of cards) from a column stack to another column stack. For example, you can move a set of cards containing a black 9 and red 8, to a red 10 on another column stack.
- ◆ After moving a card from a column stack, the next card is turned over.
- ◆ When a column stack is empty, you can move a king (along with any cards that might be in its stack) to the empty column stack.







Sumito



From the *Games/Applications* menu, scroll to the *Sumito* game and press , *Launch*. To start a new game, scroll to *NEW GAME* and press .

The object of the game is to arrange the building blocks that fall down the screen, so that they interlock to form one or more continuous horizontal lines. Once a line has been formed, it will be removed and all the blocks above it will fall down a line. You will be awarded points for each block positioned and each line formed. The game ends when the blocks reach the top of the play area.

Use the keypad to control the game:

-  - Move the block left.
-  - Move the block right .
-  - Rotate the block.
-  - Drop the block faster.
-  - Drop the block into place.
-  - Pause or exit the game.

Your score and the game status are shown at the side of the display. The shape of the next block is also shown. The level of difficulty will increase the longer the game is played.



Tenpin





From the *Games/Applications* menu, scroll to the *Tenpin* game and press , *Launch*. To start a new game, scroll to *New* and press .

The object of the game is to knock as

many of the pins down as possible. The game is played over 10 frames and in each frame you have two attempts to knock down all of the pins.

You can position the ball on the lane by pressing  or  to move across the lane.

To bowl the ball straight press  when the Swing bar is positioned in the centre of the bowling ball.

To bowl at an angle press  when the Swing bar is to the left or right of the bowling ball.

The game can be paused by pressing the  key.

Try to get the top score of 300 and enter your name on the Hi-score table!





Type your name using the keypad and press , *OK* to see the Hi-score table. Press *OK* again to return to the game menu.

Splat



From the *Games/Applications* menu, scroll to the *Splat* game and press , *Launch*. To start a new game, scroll to *New* and press . You will start on level 1. When you are

ready to play, press any key.

The object of the game is to stop the moles from digging up your garden. You will see a 3x3 grid of mole holes; when you see a mole peep through the hole, hit it by pressing the appropriate  to  key. For example, if a mole appears in the middle hole, press  to  keys.

Points are awarded for each mole hit. Watch out for surrender flags, if you hit a mole that has surrendered, points will be deducted from your score. Your score and the game status are shown at the bottom of the display. The game can be paused by pressing the  key.

At the end of a level you will receive a bonus according to your accuracy. Get an accuracy score of 70% or more to progress to the next level.

The game ends when you fail to progress to the next level or you complete the final level. You may be able to enter your name on the hi-score table. Type your name using the keypad and select , *OK* when finished.

Volume

In the *Games/Applications* menu, highlight the *Tenpin* or *Splat* game, press , *Options* and select the *Volume* option. Set the volume level for game sounds and music (*Mute*, *Quiet*, *Normal*, *Loud*).

 **Note:** The volume setting made here only applies to the *Tenpin* and *Splat* games supplied with your phone.

11 Applications

The P600 comes with some very useful applications:

- ◆ **Calculator** - A calculator with all the basic arithmetic functions. See the *Calculator* section below.
- ◆ **Converter** - Convert currency, length, weight, temperature and many more with this converter tool. See the *Converter* section on Page 46.
- 📌 **Note:** The actual applications supplied with your phone is dependent on your network service provider. Check the *Games/Applications* menu to see what applications are listed.

You can download other Java applications to your phone directly from the Internet. See the *Java* section on Page 48 for details of how to install and remove applications and games on your phone.

Calculator







You can use the calculator to perform standard arithmetic such as addition, subtraction, multiplication, and division.



▶ To use the calculator

🔍 Find it:  *Menu* ▶ *Games/Applications* ▶ *Calculator*

1 Press , *Launch* to start the Calculator.

When you open the calculator, you will see a blank sheet where calculations will be performed. Under this, the mathematical symbols that you can use are displayed.

- 2 Use the phone's keypad to enter a number. Press the  key to insert a decimal point. If you make a mistake, press the clear key  to erase the last digit entered or press the  key to clear the current calculation and start again.
- 3 Use the  and  keys to scroll through the mathematical symbols to the one that you want, and press .
- 4 Enter another number using the numeric keypad.

5 Use the  and  keys to scroll to the = symbol, and press  to perform the calculation.

🔍 **Tip:** You can perform several calculations, one after the other.

📌 **Note:** The calculator has limited accuracy, and rounding errors may occur.

6 Press , *Options* and select *Exit* to exit the calculator.

▶ To use the memory functions

- ◆ Select *M+* (Memory Add) to add a number to the number already in the memory.
- ◆ Select *MR* (Memory Recall) to recall a number from memory.
- ◆ Select *MC* (Memory Clear) to clear the memory. Note that the memory is also cleared when you exit the calculator.

Converter



Use the converter to convert:



- ◆ Area, Currency, Energy
- ◆ Length, Mass, Power
- ◆ Pressure, Temperature, Time
- ◆ Velocity, Volume

▶ To use the converter



🔍 Find it:  *Menu* ▶ *Games/Applications* ▶ *Converter*







1 Press , *Launch* to start the converter.



2 Use the  and  keys to scroll between the fields.

3 The top field is the conversion type (*Area*, *Currency*, etc.). Use the  and  keys to scroll through a list of possible conversion types.

4 Use the  and  keys to scroll to the first Unit field (*Square mm*, *Square cm*, etc.).

5 Use the  and  keys to scroll through a list of available units. Highlight the unit that you want to convert **from**.





- 6 Use the  and  keys to scroll to the next Unit field.
- 7 Use the  and  keys to scroll through a list of available units. Highlight the unit that you want to convert to.
- 8 Use the  and  keys to scroll to the first Value field, and enter the numerical value you want to convert, using the phone's keypad. The converted value is displayed in the second Value field.

You can insert a decimal point in a value by pressing the  key. To insert a negative value, use the  key.





Currency conversion

The currency converter can be used in the same way as the other conversion types. However, before you can start currency conversions you need to download the latest exchange rates from the currency server, or find them out for yourself and enter them manually.







▶ To download exchange rates

- 1 In the converter, press , *Options*.
 - 2 Scroll to the *Download rates* option and press , *Ok* to download the current exchange rates from the currency server. Press , *Agree* to confirm.
-  **Note:** You may be charged for connecting to the network to download exchange rates.
-  **Note:** Currency data is available only on an 'as is' basis without any warranty. Sendo obtains currency data from third party sources and is not responsible for the timeliness, accuracy, reliability or completeness of the currency data. Sendo does not warrant that access to the currency data will be uninterrupted or error-free. For details of the currency rate provider, please refer to the information provided when downloading rates.

▶ To set the exchange rates manually

- 1 In the converter, press , *Options*.
- 2 Scroll to the *Edit rates* option and press , *Ok*.
- 3 Scroll to the Code or Name field and use the  and  keys to scroll through the list of currencies. Highlight the currency that you want to set the rate for.
- 4 Scroll down to the Value field and enter the exchange rate against U.S. Dollars (USD). Press , *Ok* to save the new rate. For example, if 1 U.S. Dollar is currently equal to approximately 0.625 UK pounds sterling (GBP), you should enter 0.625 as the exchange rate for the UK pound sterling.
- 5 Repeat the above steps for all currencies that you want to perform conversions on.

▶ To manage your currencies

- 1 You can restrict the currencies displayed in the currency converter.
- 2 In the converter, press , *Options*.
- 3 Scroll to the *Currency manager* option and press , *Ok*.
- 4 Scroll through the list of currencies and check the box next to each currency you want to display in the converter. Use the  key to check and uncheck a currency box.
-  **Tip:** Press the  key to scroll a currency name that does not display fully in the field.
- 5 When you have finished, press , *Ok* to update your currency list.

The *Games/Applications* menu also allows you to manage the Java games and applications that came with your phone, as well as any you have downloaded.

- ❓ **Tip:** A Java file designed for use on a mobile phone is sometimes known as a MIDlet.

Downloading and installing

You can download compatible Java games and applications to your phone, directly from the Internet. For example, check out:

wap.sendo.com from your phone, or
www.sendo.com/shop from a PC or Mac

- ⚠ **Warning:** Games and applications which have not been supplied by Sendo are not guaranteed to work correctly, and you install them at your own risk. Product failures caused by any game or application not approved by Sendo will not be covered by your warranty.

- ➡ **Note:** The maximum Java file size supported by the P600 phone is 100KB. However, this may be limited further by your network. Contact your network service provider for details.

- ➡ **Note:** If you experience any problems with downloaded content, please contact the content provider.

▶ To download and install a Java file

- ◆ Using the WAP browser, simply go to the WAP page containing the Java file and it will be downloaded to your phone. You can change the filename if you wish. Press , **Save** to save and install the Java game or application.
- ➡ **Note:** Extra games and applications consume memory. If the phone starts to run low on memory, you may have to remove a Java game or application that you have installed.

- ◆ The *Games/Applications* menu may also have a **Download more** option provided by your network service provider. Select this option to launch the WAP browser and open an internet page containing details of Java games and applications for your phone.

- ➡ **Note:** This menu option is only available if supported by your network service provider. Also, you may be charged for the WAP connection and/or any Java games and applications you receive. For more details, please contact your service provider.

Deleting

You can delete one or more Java games and applications from your phone.

▶ To delete a single Java file

- 🔍 Find it:  **Menu ▶ Games/Applications**

- 1 Scroll to the Java game/application you want to delete.
- 2 Press , **Options** and select the **Delete** option. This will delete the highlighted game/application.

▶ To delete all Java files

- 🔍 Find it:  **Menu ▶ Games/Applications**

- 1 Highlight any Java game/application.
- 2 Press , **Options** and select the **Delete all** option. This will delete all the Java games and applications installed on your phone.

- ❓ **Tip:** To prevent your downloaded Java files being deleted, you can lock the file. Simply highlight the Java file, press , **Options** and select the **Lock** option.

- ➡ **Note:** All games and applications supplied with your phone are locked. A locked file cannot be deleted.

Options

 Find it:  *Menu* ▶ *Games/ Applications* ▶  *Options*

Select this	To
<i>Delete</i>	Delete the highlighted file.
<i>Details</i>	Display Java details (status, size, etc.) for the highlighted file.
<i>Lock</i>	<i>Lock</i> or <i>Unlock</i> the highlighted file. A locked file cannot be deleted.
<i>Sort</i>	Sort the Java games and applications into alphabetical order or sort by time (newest to oldest).
<i>Delete all</i>	Delete all unlocked Java files.
<i>Memory</i>	Display the total, used and free memory for Java games and applications.
<i>Data accounts</i>	Select the data account to use for network access by Java games and applications. See the <i>Data accounts</i> section on Page 56 for details on data accounts.
	 Note: The data account used must be for use by Java games and applications. This may be the same account as used for WAP access. Contact your network service provider for details.

 **Note:** If you delete any games or applications supplied with your phone, you can download them again from wap.sendo.com

Select *Pictures/Sounds* from the main menu. This menu allows you to manage the pictures and sounds on your phone.

Pictures

You can send pictures in EMS and MMS messages, or attach pictures to any main menu item, the wallpaper, the screensaver or to a contact in your contacts list.

The P600 supports standard EMS, GIF (as well as animated GIF), JPEG, BMP, WBMP, and PNG picture formats.

Downloading, receiving and saving



You can download compatible pictures to your phone, directly from the Internet or save pictures contained in an EMS or MMS message. For example, check out:

wap.sendo.com from your phone, or
www.sendo.com/shop from a PC or Mac

Warning: Pictures which have not been supplied by Sendo are not guaranteed to work correctly, and you install them at your own risk. Product failures caused by any picture not approved by Sendo will not be covered by your warranty.

Note: If you experience any problems with downloaded content, please contact the content provider.

▶ To receive, download and save a picture



- ◆ If you receive a picture in an EMS or MMS message, press , *Options* and select the *Save picture* option.
- ◆ To download a picture using the WAP browser, simply go to a WAP page containing the picture and it will be downloaded to your phone. You can change the filename if you wish. Press , *Save* to save the picture.
- ◆ You can also save pictures displayed on a WAP page. Simply highlight the picture, press , *Options* and select the *Save as* option. You can change the filename if

you wish. Press , *Save* to save the picture.

- ▶ **Note:** Pictures consume memory. If the phone starts to run low on memory, you may have to remove a picture that you have saved.
- ◆ The *Pictures* menu may also have a *Download more* option provided by your network service provider. Select this option to launch the WAP browser and open an internet page containing details of pictures for your phone.
- ▶ **Note:** This menu option is only available if supported by your network service provider. Also, you may be charged for the WAP connection and/or any pictures you receive. For more details, please contact your service provider.

Managing your pictures

Find it:  *Menu* ▶ *Pictures/Sounds*

Select the *Pictures* option to display all your pictures. You can view the pictures in full screen mode by pressing , *View*. Use the  and  keys to view each picture in turn.

Use the  and  keys to choose a picture and press  or , *Options* to display the menu options listed below:

▶ **Note:** Not all options are available for each item.

Select this To

Send as EMS or *Send as MMS*  **Note:** Only the compatible option (*EMS* or *MMS*) is displayed. Also, you may be prevented from sending items that are copy protected.

Attach  **Note:** Only the compatible option (*EMS* or *MMS*) is displayed. Also, you may be prevented from sending items that are copy protected.





Attach  Used to attach the selected picture to, for example, a menu or contact. See the *Attaching a picture* section on Page 51.

Select this	To
<i>Unattach</i>	Remove the association of the selected picture with an item.
<i>Rename</i>	Rename the selected picture.
<i>Delete</i>	Delete the selected picture.
<i>Lock</i>	Lock or Unlock the picture. A locked picture cannot be deleted.
<i>Unattach all</i>	Remove the association of all pictures to all items. Press  , OK to confirm.
<i>Details</i>	Display picture details (format, size, etc.) for the highlighted picture.
<i>Display</i>	Select how you want to display your pictures in the pictures list: <ul style="list-style-type: none"> ◆ Off - Display picture name only. ◆ Thumbnails - Display picture name and thumbnail. ◆ Full screen - Display pictures in full screen mode.
<i>Sort</i>	Sort the pictures into alphabetical order or sort by time (newest to oldest).
<i>Delete all</i>	Delete all unlocked pictures.
<i>Memory</i>	Display the amount of used memory and free memory on your phone.

 **Note:** If you delete any pictures supplied with your phone, you can download them again from wap.sendo.com

Attaching a picture

 Find it:  **Menu** ▶ **Pictures/Sounds** ▶ **Pictures**

- 1 Scroll to the picture you want, press , **Options** and select the **Attach** option.
- 2 Using the menu that follows, you can attach a picture to any main menu item, the wallpaper, the screensaver or to a contact in your contacts list. Make your choice using the  and  keys and press , **Select**.

If you select the **Contacts** or **Main menu** option a new sub-menu will be displayed.

Select the contact or menu name you would like to attach the picture to.

 **Note:** To display pictures in the main menu, animations will be set to **Off**. See the **Display** settings section on Page 54 for details.

 **Note:** For good display performance, we recommend that you restrict the size of menu pictures to a maximum 160x120 pixels (Small or Extra Small size pictures from the camera are ideal).

Sounds

You can send sounds in EMS and MMS messages, or attach ringtones to a contact in your contacts list.

The P600 supports standard EMS and MMS sounds, AMR, SMAF and sp-midi polyphonic ringtones, plus i-melody and Standard Smart Messaging monophonic ringtones.



Downloading, receiving and saving

You can download compatible ringtones to your phone, directly from the Internet or save ringtones contained in an EMS or MMS message. For example, check out:

wap.sendo.com from your phone, or **www.sendo.com/shop** from a PC or Mac

 **Warning:** Ringtones which have not been supplied by Sendo are not guaranteed to work correctly, and you install them at your own risk. Product failures caused by any ringtone not approved by Sendo will not be covered by your warranty.





▶ To receive, download and save a ringtone

- ◆ If you receive a ringtone in an EMS or MMS message, press , **Options** and select the **Save ringtone** or **Save sound** option.
- ◆ Using the WAP browser, simply go to a WAP page containing the ringtone and it will be downloaded to your phone. You can change the filename if you wish. Press , **Save** to save the ringtone.

- **Note:** Ringtones consume memory. If the phone starts to run low on memory, you may have to remove a ringtone.
- ◆ The **Sounds** menu may also have a **Download more** option provided by your network service provider. Select this option to launch the WAP browser and open an internet page containing details of ringtones for your phone.
- **Note:** This menu option is only available if supported by your network service provider. Also, you may be charged for the WAP connection and/or any ringtones you receive. For more details, please contact your service provider.



Managing your sounds

📞 Find it:  **Menu** ▶ **Pictures/Sounds**

Select the **Sounds** option to display all your sounds. Use the  and  keys to scroll through the list of sounds. You can play the sounds by pressing , **Play**. Press , **Options** to display the menu options listed below:

- **Note:** Not all options are available for each item.

Select this To

- | | |
|----------------------|---|
| Volume | Change the volume setting for ringtones and sounds. Use the  and  keys to increase and decrease the volume level. |
| Set as ringer | Set this sound as the main ringtone for your phone. |
| Send as MMS | Send the sound in an MMS message. <ul style="list-style-type: none"> ➤ Note: You may be prevented from sending items that are copy protected. |
| Attach | Attach the selected sound to a contact in your contacts list. See the <i>Attaching a ringtone</i> section on Page 52. |



Select this To

- | | |
|---------------------|---|
| Unattach | Remove the association of the selected sound with a contact. |
| Rename | Rename the selected sound. |
| Delete | Delete the selected sound. |
| Lock | Lock or Unlock the sound. A locked sound cannot be deleted. |
| Unattach all | Remove the association of all sounds to all contacts. Press  , OK to confirm. |
| Details | Display sound details (format, size, etc.) for the highlighted sound. |
| Sort | Sort the sounds into alphabetical order or sort by date (ascending or descending). |
| Delete all | Delete all unlocked sounds. |
| Memory | Display the amount of used memory and free memory on your phone. |
-

- **Note:** If you delete any sounds supplied with your phone, you can download them again from wap.sendo.com

Attaching a ringtone

📞 Find it:  **Menu** ▶ **Pictures/Sounds** ▶ **Sounds**

- 1 Scroll to the sound you want, press , **Options** and select the **Attach** option.
- 2 Scroll through the list of contacts and press , **Select** to attach the ringtone.

If the contact has more than one number (**Mobile, Work, Home**), scroll to the number you want and press , **Select**.

The ringtone is played when a call is received from the individual contact/number (as long as the caller's number can be seen by your phone - for example, not withheld).





Select **Settings** from the main menu. This menu allows you to define the settings for your phone.

-  **Note:** The contents of the **Settings** menu may vary by network service provider. Please review your phone's menu to determine the menu items and features available on your phone.

Languages

-  Find it:  **Menu** ▶ **Settings** ▶ **Languages**

This menu allows you to change the language on the phone.

-  **Tip:** If the phone language is changed by mistake, press and hold  in the main screen to display the language list. Scroll to the language you want (using  and ) and press .

Time/Date

-  Find it:  **Menu** ▶ **Settings** ▶ **Time/Date**

Select this menu to set the time and date on your phone. The options are:

Set time

Enter the time and press , **OK**. The time will be stored.

Set date

Enter the date and press , **OK**. The date will be stored.

Time format

Use this to choose whether to display the time in AM/PM or 24hr format.

Auto update

You can update the time and date automatically from the network. Select **On** to use the time and date from the network, select **Off** to never use the time and date from the network, or select **Confirm** to check the time and date from the network before any update.

-  **Note:** This option is only available if supported by your network service provider. Check with your service provider for details.

Display clock

Turn the time display **On** or **Off**.

Alarm

-  Find it:  **Menu** ▶ **Settings** ▶ **Alarm**

You can use your phone as an alarm clock.



Set the alarm to **On** and enter the time when you require the phone to ring (in 24 hour format). When it rings press:



, **Off** to switch it off, or

, **Snooze** to stop the alarm for ten minutes. The alarm will then sound again.

Please observe the following notes:

Note

When activated, the alarm will sound for approximately 45 seconds before switching off (if you do not press , **Off** or , **Snooze**).

If the alarm activates during a call, the phone will beep and the display will flash to indicate that the alarm is active. As described above, press , **Off** to switch it off, or , **Snooze** to stop the alarm for ten minutes.

If the volume is set to silent mode, the alarm will activate but there will be no sound. The phone will still vibrate if the vibrate feature is on.

The alarm will sound even if the phone is switched off. The phone will power on (if battery power is available) but you will not be able to receive or make calls. If the volume was set to silent mode before the phone was switched off, the alarm will still sound as silent mode is cancelled when the phone is switched off. Once the alarm finishes, the phone will switch off automatically.

Display

 Find it:  *Menu* ▶ *Settings* ▶ *Display*



This menu allows you to change the settings for your phone's displays. The options are as follows:

Backlight

You can specify default times for the backlight on the phone.

 **Note:** The backlight timer settings do not affect the backlight settings for WAP and games.

LCD contrast

Set the contrast of the screen using the  and  keys.

Themes



Select this option to choose the theme (colour scheme) to be used throughout all your phone's menus.

Wallpaper

Select this option to turn this feature **On** or **Off** and assign a picture from the phone's memory (using *Select picture*). The wallpaper is displayed in the main screen. The *Format* option lets you choose how to display the image: *Full screen* (resize the image to fill the screen), *Centre* (centre the image on the screen), *Mosaic* (tile a small image to fill the screen).

Screensaver

Select this option to turn this feature **On** or **Off**, set the *Delay* before it becomes active and assign a screensaver picture or animation from the phone's memory (using *Select picture*). The screensaver is displayed when the phone has been idle for the set delay.

 **Note:** When the screensaver is displayed, press any key to return to normal display (or press , *Unlock* then  if the keypad is locked).

The screensaver settings do not affect power save mode.

Animations

Select this option to turn main menu animations **On** or **Off**.

Sounds

 Find it:  *Menu* ▶ *Settings* ▶ *Sounds*



This menu allows you to change the settings for your phone's sounds. The options are listed below.



Ringer



Select this option to set the main ringtone for incoming calls. Scroll through the list of ringtones - as you pause on each ringtone, it will be played. Press , *Select* to select the ringtone.

 **Tip:** You can also set ringtones for individual contacts. See the *Attaching a ringtone* section on Page 52 for details.

Volume



Select this option to change the volume setting for ringtones and sounds. Use the  and  keys to increase and decrease the volume level.

 **Note:** The earpiece volume can be adjusted during a call. Press  to make the speech louder and  to make it quieter.

To enter/exit silent mode, you can press  then  from the main screen. The silent symbol,  is displayed on the main screen when the phone is in silent mode.

 **Note:** If the vibrate function is set to on, the phone will still vibrate whilst in silent mode.

 **Note:** If the phone is switched off, silent mode is cancelled. This helps to ensure no calls are missed.

 **Tip:** Press the  key with the volume set to maximum, and an arrow will appear.

With this setting, ringtones are played with a steadily increasing volume.

Key Tones

This menu allows you to set the type of keypad tones that you would like to hear when pressing the keys:

Off

No sound emitted on a key press.

On

Short, low volume tone.

DTMF

These are standard tones, as used in touch tone phones. Each number has its own specific tone.

On/Off melody

The phone can play a melody whenever you switch it on or off. Select this option to switch this feature *On* or *Off*.

Vibrator

Select this menu to set the vibrate function for incoming calls and alert sounds:

Off

Deactivates the vibrate function.

On

Sets the phone to vibrate for an incoming calls or messages.

Vibrate then ring

Sets the phone to vibrate for a few seconds before the phone starts to ring.

 **Note:** None of the vibrate settings affects any of the sounds settings.

Events

This menu allows you to set the sounds that you would like to hear for certain events:

New message

The phone can play a sound when a new message is received (SMS, EMS, MMS or voicemail). Select this option to switch this feature *On* or *Off*, and to *Change* the sound played.

New broadcast

The phone can play a sound when a new broadcast message is received. Select this option to switch this feature *On* or *Off*.

Low battery

The phone can play a sound when the battery is low. Select this option to switch this feature *On* or *Off*.

 **Note:** Alert sounds can only be applied to those services supported by your network service provider. When roaming, certain services may not be supported. Contact your service provider for details

Advanced

 Find it:  Menu ▶ Settings ▶ *Advanced*

Select this menu to define how you deal with incoming calls and to set your security settings. The options are as follows:

Auto redial

When auto redial is activated, the phone will automatically redial a number when the call attempt fails. If the other user's phone is busy, the phone will wait a few seconds before each attempt, and then beep when it succeeds.

Auto answer

This function is only applicable when certain hands-free accessories (for example, a personal hands-free headset) are connected to the phone. When you receive an incoming call with this feature activated, the phone rings three times before automatically accepting the call.

Any key answer

When this function is activated, you can answer an incoming call by pressing any key, except , *Reject*.

Voice mail

Select this option to enter/change your voice mailbox number. This number is available from your network service provider.

- **Note:** Voice mail is a network service. You may have to subscribe to this service and it may not be available when roaming. Check with your network service provider for details.

Security

Used to define your PIN security settings. See the *Security* section below for details.

Factory settings

Select this option to reset the phone's settings to their original values. Press , **OK** to confirm the reset.

- **Note:** Not all settings can be restored to their original values.

Security

The *Security* menu under *Advanced* settings is used to define your PIN settings. Your PIN (Personal Identity Number) is a code that you can use to protect your phone against unwanted use. This is the number that the phone may ask for at switch on. The options are as follows (depending on what PIN activation settings you have selected):

Activate PIN

Enter your PIN at switch on (if your SIM card supports this).

Deactivate PIN

You do not have to enter your PIN at switch on.

Change PIN

Select this to change your PIN code.

Change PIN2

Some network services require a separate security code - the PIN2 code. Select this option to change your PIN2 code.

To activate, deactivate or change the PIN code, you need to enter the current PIN code. To change the PIN2 code, you need to enter the current PIN2 code. If you don't know your PIN code or PIN2 code, contact your network service provider.

If you enter the wrong PIN or PIN2 code three times, the SIM card is locked and you may be

asked to enter a PUK (Personal Unlock Key) code - these may be different for PIN and PIN2. The PUK codes may be listed in the information that you received with your SIM card or they may only be available from your network service provider.

- **Note:** The number of incorrect entries depends on your network service provider.
- **Note:** Sendo cannot provide your PIN or PUK codes. Contact your network service provider for information.

Data accounts

Find it:  **Menu** ▶ **Settings** ▶ **Data accounts**

Select this option to define the accounts used for MMS and WAP services. These settings may have already been configured on your phone by your network service provider. If your phone is not configured already, the fastest and easiest way to do this is to visit:

<http://www.sendo.com/config>

to automatically configure your settings. The Sendo Easy Configurator sends an SMS message to your phone containing the settings you require. Alternatively, you can ask your network service provider to send you this information (if available).

Data accounts are grouped into profiles. A profile is a collection of settings for network access. Select an account from the list displayed to change the current settings, or select **Add new** to define a new account. The settings are as follows:

Name

A name for the account.

Username

The username to log on to the external data network.

Password

The password to log on to the external data network. Enter your password and press , **OK** to save.

Access point

If you are using a GPRS connection, use this option to specify the GPRS access point name.

Dial up number

If you are using a GSM connection, use this option to specify the dial up number.

Dial type

If you are using a GSM connection, use this option to specify whether you want to use an **Analog** or an **ISDN** connection. Press , **OK** to save your selection.

Connect. type





Select whether to use a GSM, GPRS, or CSD connection. To use GPRS, you must have a GPRS subscription. Please check with your network service provider.

Timeout

Enter the number of seconds of inactivity after which your connection to the internet should be ended.

Shortcuts

 Find it:  **Menu** ▶ **Settings** ▶ **Shortcuts**



Select this option to set the features accessed when you press the up, down, left or right navigation keys (, ,  or ) from the main screen.

Select the **Left**, **Right**, **Up** or **Down** option as required, scroll to the feature you want to assign to the key, and press , **Select**.

Auto key lock

 Find it:  **Menu** ▶ **Settings** ▶ **Auto key lock**

Select this menu to change the keypad lock settings:

 To lock/unlock the keypad at any time, press , then  from the main screen.



Off

Deactivates the key lock function.

On

Sets the phone to automatically lock the keypad (from the main screen only) if no keys are pressed after a period of time.

When the keypad is locked, the locked symbol, , is displayed on the main screen.

Press , **Unlock** and then  to unlock the keypad.

Delay

Set the delay before the keypad lock becomes active.

Select **Services** from the main menu. This menu allows you to set up network services such as call waiting.

- 📌 **Note:** The contents of this menu may vary by network service provider. Please review your phone's menu to determine the menu items and features available on your phone.

Commands

- 📞 Find it:  **Menu** ▶ **Services** ▶ **Commands**

This menu allows you to send special commands to the network to get specific information. This could be information such as the time and date, your own phone number, or the amount of credit remaining on your SIM card.

The commands, and whether this feature is available, can be obtained from your network service provider.

You can store the number of the command and a name. Once stored, scroll to the command and press , **Send** to get the required information from the network.

Network sel. (selection)

- 📞 Find it:  **Menu** ▶ **Services** ▶ **Network sel.**

This menu allows you to choose how the phone searches for the network. The options are as follows:

- 📌 **Note:** The ability to select alternative networks will depend on the service, or roaming, agreement of your network service provider.

Mode

- ♦ **Automatic** - Sets the search mode to automatic. The phone searches all available networks and automatically selects one.

- ♦ **Manual** - Sets the search mode to manual. This allows you to search available networks and select one - see below for details.

Search

- ♦ Searches for and then displays all available networks.
- ♦ If you are in manual mode (see above), you can select a network which will become your default network. To do this, scroll through the network list and press , **Select** on the network that you wish to use. Once you select a network, your phone will always try to select this network. Network selection stays manual until you switch to automatic mode.

Send number

- 📞 Find it:  **Menu** ▶ **Services** ▶ **Send Number**

This menu allows you to select whether you hide your identity or not when you call someone. The options are as follows:

Network

This sets the phone to the Network default setting.

On

Your telephone number is sent to your correspondent when you call.

Off

Your telephone number is not sent to your correspondent when you call.

Cost/timers

- 📞 Find it:  **Menu** ▶ **Services** ▶ **Cost/timers**

This menu contains information on the amount of time you have spent on calls and the amount of data transferred using GPRS.

- 📌 **Note:** The actual time, data and charges invoiced for calls and services by your network service provider may vary, depending on network features to which

you subscribe, rounding off, taxes and other fees and charges.

The options are listed below. Once selected, press , **Reset** to reset a counter to zero.

Outgoing

Displays the total time that you have spent on your phone on outgoing calls.

Incoming

Displays the total time that you have spent on your phone on incoming calls.

GPRS data

Displays the amount of data transferred using GPRS services.

Divert

 Find it:  **Menu** ▶ **Services** ▶ **Divert**

This network feature allows you to divert your incoming calls to your voice mailbox or to another number. The options are as follows:

 **Note:** Your network may not support all of these features. Any unsupported features will not be shown in the menu.

If busy

When activated, calls will be diverted if you are already in a call.

If no answer

When activated, calls will be diverted if you do not answer your phone.

Unreachable

When activated, calls will be diverted if your phone is off or if you are out of coverage.

All conditional

When activated, the calls which you have specified here are diverted. Select voice, fax, data or all calls.

All calls

When activated, all of your incoming calls will be diverted.

For each of the above, you can check, activate or cancel the service.

 **Note:** Certain divert features may not be available if roaming on another network. Contact your network service provider for details.

Call waiting

 Find it:  **Menu** ▶ **Services** ▶ **Call waiting**

This menu allows you to activate or deactivate the call waiting feature. For more information on call waiting, please see the *Answering a call* section on Page 14.





 **Note:** Call waiting is a network service. You may have to subscribe to this service and it may not be available when roaming. Check with your service provider for details.





Broadcast











 Find it:  **Menu** ▶ **Services** ▶ **Broadcast**









Your network service provider may offer Cell Broadcast messages. This could be information on the traffic, weather, events, or local information which is broadcast by the network to all mobiles in a specific area. When you activate this feature, you may receive messages about the selected topic. Contact your service provider for more details.

 **Note:** This is a network service which may not always be available. Check with your service provider.

Problem	Possible cause	Possible corrective action
Phone does not power on/does not charge	<p>Delay in phone powering on</p> <p>Battery empty</p> <p>Battery contacts dirty</p> <p>Charger incorrectly connected</p>	<p>No action required. Your P600 phone may take a few seconds to power up, this is normal.</p> <p>Fully charge the battery and then press .</p> <p>Don't worry if the battery icon does not change immediately, but do check if the charging icon has appeared after half an hour.</p> <p>Clean contacts on battery and phone with a dry cloth, attach battery, wait a few seconds and press .</p> <p>Check the wall socket, and the connection to the phone.</p>
Battery	How long should I charge the battery the first time?	12 hours continuous, whilst switched off.
I don't get as much battery life as I expected	The phone uses battery power when it is switched on even if it is not in a call. Making calls and playing with the different functions of the phone will run down the battery faster. The stated battery life is under optimum conditions.	<ul style="list-style-type: none"> ◆ Charge the phone regularly. ◆ For longer operation times, discharge the battery from time to time by leaving your phone switched on until it turns itself off and the battery is fully discharged. ◆ The battery can be charged and discharged hundreds of times, but it will eventually wear out. When the operating time (talk time and standby time) is noticeably shorter than normal, it may be time to buy a new battery.
"Insert SIM" is displayed when I switch on the phone	<p>SIM card is incorrectly inserted or missing.</p> <p>SIM card is damaged or dirty</p>	<div style="text-align: center;">  </div> <p>Check that the SIM card is positioned correctly. Try again.</p> <p>Visually check the SIM and clean the contacts with a soft, dry cloth if necessary. Try again.</p>
The PIN code is blocked, or My phone asks for a PUK code	You have entered the PIN code incorrectly 3 times	<p>Enter the PUK (Personal Unlock Key) code supplied with the SIM card. If you do not have this code, contact your network service provider.</p> <p> Note: The number of incorrect entries depends on your network service provider.</p>
The PIN2 code is blocked, or My phone asks for a PUK2 code	You have entered the PIN2 code incorrectly 3 times	<p>Enter the PIN2 PUK (Personal Unlock Key) code supplied with the SIM card. If you do not have this code, contact your network service provider.</p> <p> Note: The number of incorrect entries depends on your network service provider.</p>

Problem	Possible cause	Possible corrective action
"NCK Code" is displayed on my handset	The handset is locked to a network and a SIM from another network has been placed in the phone	Remove the SIM and insert the correct network SIM. Sendo cannot supply your NCK code. If you wish to obtain your NCK code, contact the original network service provider the phone was purchased for use on. ⚠ Warning: If you enter the wrong NCK code you could block the phone.
"Blocked" is displayed on my handset	The NCK code has been entered incorrectly 10 times and the handset has been security disabled	Contact your network service provider for advice. 📌 Note: The number of incorrect entries depends on your network service provider.
There's a problem with my downloaded ringtone, picture, game or application	Corrupt file Incompatible format Copy protected content	Contact your content provider for advice.
A key on the keypad is not working	Key lock on	The keypad may be locked. Check the screen for the  symbol. Press  and  in quick succession to unlock the keypad.
Poor display	Low temperature Incorrect contrast setting. Wallpaper settings	Move to a warmer place and let the phone warm up. You may have an incorrect contrast setting for the display. Change the setting as needed. 🔍 Find it:  Menu ▶ Settings ▶ Display ▶ LCD contrast If you've added your own wallpaper, check that the colours do not clash with the text colours used on screen as this could make it difficult to read.
Can't connect to network	Weak signal Invalid SIM card Network not allowed	You may be in an area of poor coverage. Move to an area with a better signal. ♦ Try switching your phone off and then back on. ♦ Try changing your network settings. See the Network sel. (selection) section on Page 58 for details. ♦ You may need to contact your network service provider for advice. Try reselecting the network. Switch off and then back on. If you are using your phone abroad, you may be restricted from certain networks - contact your network service provider for information.
Can't make/receive calls	Weak signal Phone is switched off Battery is low	Check that the service provider name is displayed on the screen. If not, try to reconnect to the network or move to an area with a better signal. Press  for a few seconds. Phone can power down if the battery is very low. Charge the battery.

Problem	Possible cause	Possible corrective action
	Check the number	Use the full area code and country code in the number.
	Call key not pressed	After dialling the number you must press  , Call .
	Network is busy	If you hear rapid beeps, then the network is busy. Hang up and try again or try in another area.
	Fixed names or call barring is activated	Check the fixed names settings (in Contacts). Otherwise check the call barring settings with your network service provider.  Find it:  Contacts ▶ Fixed names
	Not registered with network service provider	After purchasing your phone, you may need to call your network service provider to activate the line.
	No credit left on your prepaid card	Recharge your credit.
Low earpiece volume	Low setting	Press  when you are in a call to increase the volume.
Low ringtone volume	Low setting	Go into the Sounds menu in Settings , select Volume and increase the setting.  Find it:  Menu ▶ Settings ▶ Sounds ▶ Volume
Cannot enter some words	Wrong word displayed	Your phone has T9 text input (i.e. it predicts what words you are trying to enter). When you finish a word, press  repeatedly to scroll through the possible words.
	Wrong entry mode	To enter a special word press  repeatedly to change to normal Multitap mode (ab or AB).
I can't send or receive MMS messages	Incorrect MMS settings	See the MMS settings section on Page 23 for details. You may need to contact your network service provider for details of the settings required.
	Your SIM card is not GPRS or MMS enabled	You need a GPRS and MMS enabled SIM card in order to use MMS services. Contact your network service provider for information.
	No GPRS coverage	You may be in an area of poor GPRS coverage. Move to an area with a better signal.
	Message too large	The maximum message size supported by the P600 phone is 100KB. However, this may be limited further by your network. Contact your network service provider for details.
"Message list full" is displayed in the main screen	Your messages memory is full of text and MMS messages, therefore you cannot receive any more messages.	Go into the Inbox of the Messages menu and delete some of your messages.  Find it:  Menu ▶ Messages ▶ Inbox
Some features do not work	Feature not supported by the operator or your subscription.	Contact your network service provider.

Problem	Possible cause	Possible corrective action
Some menus are missing	There are restrictions on your SIM card or subscription.	Contact your network service provider.
My phone language is wrong	Language changed by mistake or incorrect setting	If the phone language is incorrect or changed by mistake, press and hold  from the main screen to display the language list. Scroll to the language you want (using  and ) and press  .
I can only enter names of up to 7 characters in my contacts list	Your phone is in Unicode mode.	Change the Characters setting to GSM mode.  Find it:  Menu ▶ Messages ▶ Settings ▶ SMS settings
I can only enter one number for a contact	You are using SIM contacts.	Change the Default setting in Contacts to Phone .  Find it:  Contacts ▶ Default
"List full" is displayed on my Contacts screen	Contacts list full	This will not cause problems using your phone, but if you want to add more contacts you must delete some existing contacts.
I'm having problems using GPRS on my phone	Your SIM card is not GPRS enabled	You need a GPRS enabled SIM card in order to use GPRS services. Contact your network service provider for information.
	No GPRS coverage	You may be in an area of poor GPRS coverage. Move to an area with a better signal.
	Incorrect GPRS settings	See the MMS , Internet and Data accounts settings sections for details. You may need to contact your network service provider for details of the settings required.
A "Wap Error" message is displayed on the screen	Weak signal	You may be in an area of poor network coverage. Move to an area with a better signal.
	Incorrect Internet settings	See the Settings section (Page 27) in the Internet chapter for details. You may need to contact your network service provider for details of the settings required.
	Gateway or site problems	There may be problems with the WAP gateway or individual WAP site. Contact your network service provider for information.

 **Note:** For all further questions, support and service issues, please go to www.sendo.com/support.

17 Regulatory Statements

Mobile Manufacturers Forum statement: Understanding SAR

To communicate with the network, mobile phones emit low levels of radio waves (also known as radiofrequency or 'RF' energy) when being used. Governments around the world have adopted comprehensive guidelines, developed by independent scientific organisations, governing the exposure to RF energy. Mobile phones are designed to operate within these stringent limits.

What is SAR?

SAR stands for Specific Absorption Rate which is the unit of measurement for the amount of RF energy absorbed by the body when using a mobile phone. Although the SAR is determined at the highest certified power level in laboratory conditions, the actual SAR level of the phone while operating can be well below this value. This is because the phone is designed to use the minimum power required to reach the network. Therefore, the closer you are to a base station, the more likely it is that the actual SAR level will be lower.

Does a lower SAR mean that a phone is safer?

No. Variations in SAR do not mean that there are variations in safety. While there may be differences in SAR levels among phone models, all mobile phones must meet RF exposure guidelines.

Where can I get the SAR values for my phone?

SAR information for new model phones will be included with the materials that come with the mobile phone. In addition, this information will be available from the website of your mobile phone manufacturer.

Where can I go if I want more information?

There are several good sources of information by government and international agencies on the general issue of mobile phones and health:

World Health Organisation (WHO)

www.who.int/emf

U.S. Food and Drug Administration

www.fda.gov/cdrh/ocd/mobilphone.html

U.K. National Radiological Protection Board

www.nrpb.org.uk

The Mobile Manufacturers Forum, the international association of mobile phone manufacturers, also has a comprehensive website – www.mmfa.org - to help answer consumer questions on health issues.

Sendo SAR Statement

THIS MOBILE PHONE MEETS REQUIREMENTS FOR EXPOSURE TO RADIO FREQUENCY ENERGY.

Your mobile phone is a radio transmitter and receiver. It is designed and manufactured not to exceed the limits for exposure to radio frequency (RF) recommended by international guidelines. These limits are part of comprehensive guidelines and establish permitted levels of RF energy for the general population. The guidelines were developed by independent scientific organisations through periodic and thorough evaluation of scientific studies. The guidelines include a substantial safety margin designed to assure the safety of all persons, regardless of age and health.

The exposure standard for mobile phones employs a unit of measurement known as the Specific Absorption Rate, or SAR. The SAR limit recommended by international guidelines is 2.0 Watts/kg*. Tests for SAR are conducted using standard operating positions with the phone transmitting at its highest operating power level. Although the SAR is determined at the highest operating power level, the actual SAR of the phone while operating normally can be well below the maximum value. This is because the phone is designed to operate at multiple power levels so as to use only the power required to communicate with the network. In general, the closer you are to a base station, the lower the power output of the phone. The highest SAR value for the Sendo 600 model phone when tested for use at the ear is 1.370 W/Kg. Always read and follow the operating and safety instructions that came with your phone.

* The SAR limit for mobile phones used by the public is 2.0 Watts/Kg (W/kg) averaged over ten grams of body tissue. The guidelines incorporate a substantial margin of safety to give additional protection for the public and to account for any variations in measurements.

Regulatory Compliance

Your phone has been designed to comply with applicable standards when used correctly in accordance with the user instructions. Sendo GSM 900/1800 phones and accessories have been tested and certified for compliance with the following EC Directives and international standards, as applicable:

European (EC) Directives

1999/5/EC (R&TTED)

89/336/EEC (EMCD)

73/23/EEC (LVD), as amended by 93/68/EEC

International Standards

IEC/UL/AS-NZ/BS EN60950 (Electrical Safety)

EN301 489-7 (EMC)

EN301 489-1 (EMC)

EN301 511 (GSM900/DCS1800)

International SAR (Human Exposure) Standards

EN50360/EN50361 (European)

IEEE Std C95.3 (USA)

AS/NZ 2772.1 (ACA, Australia)

Declaration of Conformity

We: Sendo International Ltd.

Of: Sendo Base Station, Hatchford Brook, Hatchford Way, Sheldon, Birmingham, B26 3RZ, United Kingdom.

Declare under our sole responsibility that the product referenced within this user guide and uniquely identified by the IMEI and type number affixed to the product, to which this declaration relates, is in compliance with the essential requirements of the Radio and Telecommunications Terminal Equipment Directive (R&TTE) 1999/5/EC.

The conformity assessment procedure referred to in Article 10 and detailed in Annex IV of the R&TTE Directive (1999/5/EC) has been followed with the involvement of the UK Notified Body, BABT, Claremont House, 34 Molesey Road, Walton-On-Thames, KT12 4RQ, England.

A copy of the original Declaration of Conformity is available for download from the Sendo website.

Class of equipment: This product is designated Class 1 equipment (R&TTED 1999/5/EC), the use of which is harmonised throughout all EU member states. This product is designated for use on licensed GSM 900/1800 MHz networks.

www.sendo.com

CE 0168

8E30-T4011-50001

Printed in the EU.

© 2004 Sendo. All rights reserved.