

User's Guide



Nokia is a registered trademark of Nokia Corporation, Finland.
Navi is a trademark of Nokia Mobile Phones.

© 1999. Nokia Mobile Phones. All rights reserved.

Nokia Mobile Phones operates a policy of continuous development. Therefore, we reserve the right to make changes and improvements to any of the products described in this guide without prior notice.

Smart Tips

These Smart Tips pages include some useful tips for efficient usage of your phone.



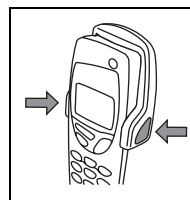

For more detailed information, read through the user's guide.



Lift off the handset











Press at least one push button of the cradle to lift off the handset.

Call functions

Making a call	Key in the phone number including the area code, press the Navi Key  (Call).
Answering a call	Press the Navi Key  (Answer).
Ending a call	Press the Navi Key  (End).
Rejecting a call	Press  upon receiving an incoming call. (If the Divert when busy function is activated, rejecting an incoming call will also divert the call).

Redial	With display clear, press  to access the last-dialled numbers.
Adjusting the volume	Press  during a call.
Switching to handsfree	Press  , then put the handset back onto the cradle.

Phone book functions

Quick save in Phone book	Key in the phone number, press  to change the Navi Key text to Save . Press  (Save). Key in the name and press  (OK).
Quick find in Phone book	Press  (with display clear), key in the first letter of the name and use  to scroll to the desired name. Press and hold  to view the phone number.
Using the Phone book during a call	To access the Phone book during a call, press  ,  (Options) and select Phone book .

Storing a phone number for speed dialling	Press (Menu), (Select), use to find Speed dials , press (Select), (Assign), find the desired name/phone number and press (OK).
Speed dialling	Press a number key - and press (Call).
Calling the mailbox	Press and hold to dial the voice mailbox number. (The voice mailbox number has to be stored in the memory).
One touch dialling	If the Speed dialling function in the menu is activated, press and hold a number key - for one touch dialling.

Essential shortcuts

Reading messages	<p>Press (Read) to reach the messages, use to browse through the messages.</p> <p>Press (Options) for available options.</p> <p>Press (C) to exit the messages.</p>
------------------	---

Writing / sending a message	<p>Press (Menu), , , key in a message (press (#*) to change between upper and lower case characters, press and hold (#*) for numbers, press (*+) for special characters).</p> <p>Press (Options), access Send via , press (OK), enter the phone number or search for it in the Phone book using , then press (OK).</p>
SIM card priority	<p>Press (Menu), , , , to prioritise radio unit SIM or press (Menu), , , , to prioritise handset SIM.</p>
Selecting a ringing tone	Press (Menu), , to select a ringing tone out of the available list.
Selecting the ringing volume	Press (Menu), , to select the ringing volume level.

Table of contents

For Your Safety	7	Text messages	16
Welcome	8	Fax and data call	17
About labels on your car phone	8	Ignition sense	17
Security code	8	Automatic power-off	18
Using this guide	8	Car radio mute	18
1. Getting Started	9	Backlight dimming	18
Inserting a SIM card in the radio unit	9	4. Using the Menu	19
Inserting a SIM card in the handset	9	Accessing the menus by scrolling	19
Using the keys	10	Accessing the menus by shortcut	19
Switching the car phone on and off	10	List of menu functions	20
The display indicators	11	1 Phone book	22
2. Basic Functions	12	2 Messages	24
Making a call	12	3 Call register	26
Receiving a call	12	4 Settings	27
Adjusting the volume	13	5 Call divert	30
Redialling last number	13	6 Call counters	30
Storing a name and phone number in the Phone book	13	7 Calculator	31
Making a call using the Phone book	14	8 Clock	32
3. Other Essential Functions	15	9 Tones	32
Setting the time	15	5. Reference Information	34
Selecting a ringing tone	15	Facts about cellular transmission	34
In-call options	15	Access codes	35
Voice messages	16	Battery information	36
		Accessories	37
		6090 DIN/ISO installation kit	37

Care and Maintenance	38
Important Safety Information	39
Traffic safety	39
Operating environment	39
Electronic devices	39
Potentially explosive atmospheres	40
Vehicles	40
Emergency calls	41
Installation	42
Glossary	44
Index	46

For Your Safety



Read these simple guidelines. Breaking the rules may be dangerous or illegal. Further detailed information is given in this manual.



ROAD SAFETY COMES FIRST

Don't use a handheld phone while driving; park the vehicle first.



INTERFERENCE

All wireless phones may get interference which could affect performance.



SWITCH OFF IN HOSPITALS

Follow any regulations or rules. Switch phone off near medical equipment.



SWITCH OFF WHEN REFUELING

Don't use phone at a refuelling point. Don't use near fuel or chemicals.



SWITCH OFF NEAR BLASTING

Don't use phone where blasting is in progress. Observe restrictions, and follow any regulations or rules.



MAGNETISM

ATM and credit cards brought into contact with the cradle may be demagnetized and information stored on the card erased. Avoid storage of ATM and credit cards near your cradle.



USE QUALIFIED SERVICE

Only qualified service personnel must install or repair equipment.



ACCESSORIES

Use only approved accessories. Do not connect incompatible products.





CONNECTION TO OTHER DEVICES

When connecting to any other device, read its user's guide for detailed safety instructions. Do not connect incompatible products. Remember to make backup copies of all important data.





MAKING CALLS

Ensure the phone is switched on and in service. Enter the phone number, including the area code, then press  (Call). To end a call, press  (End). To answer a call press  (Answer).



EMERGENCY CALLS

Make sure the phone is switched on and in service. Hold  for several seconds, to clear the display. Enter the emergency number, then press  (Call). Give your location. Do not end the call until told to do so.

Welcome

We congratulate you on your purchase of this mobile car phone, which allows you access to GSM900 networks worldwide.

GSM, the Global System for Mobile Communications, is the digital standard used in many countries throughout the world, enabling you to benefit from the GSM services provided by your car phone.

About labels on your car phone

Your car phone has labels on it which are important for service and related purposes. Therefore be careful not to remove or lose any label or the information it contains.

Security code

The factory setting for the security code is 12345. It is supplied with the car phone on an identification sticker. The security code protects your car phone against unauthorised use.

Change the code, see "4-3 Security settings" on page 28, and keep the new code secret and in a safe place separate from the car phone.

Using this guide

The car phone described in this guide is approved for use on the GSM900 network.

There are a number of features included in this guide which are called Network Services. They are special services provided by wireless service providers. Before you can take advantage of any of these Network Services, you must subscribe to these service(s) with your home service provider and obtain instructions for their use.

In this manual, the menu names and commands that appear on the display of your phone are always in **bold** print. For example: **Phone book, calling**.

1. Getting Started

Your car phone consists of two major parts:

1. Handset
2. Radio unit

Before you can use your car phone, you must place a SIM (Subscriber Identity Module) card in the phone.

Your car phone has two SIM card readers: one in the radio unit and the other in the handset. The factory setting assigns the card reader in the handset priority; the car phone will only work with the prioritised card (e.g. Phone book).

The user can change the priority of the card readers for use via the menu, see "4-2-7 SIM card priority" on page 28. The user's priority setting is then used as a default setting. If only one reader is initially loaded with a card, that reader is automatically used.

If an invalid or corrupted SIM card is used in the prioritised card reader, the user is notified through a message on the display. The phone will not try to use a different card reader with a lower priority. Switch off the car phone and remove the invalid SIM card. Then restart the car phone. The car phone will then work with the second SIM card.

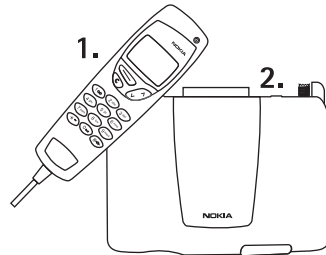

Inserting a SIM card in the radio unit

The SIM card and the contacts stored in it can easily be damaged if scratched or bent, so be careful when handling, inserting or removing the card.

Before you insert the SIM card, make sure that the car phone has been switched off!

Insert the SIM card into the slot so that the contacts are towards the radio unit.

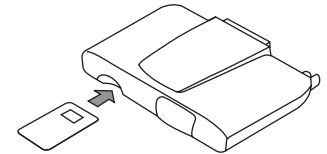

Inserting a SIM card in the handset

Warning! Keep all miniature SIM cards out of the reach of small children.



Before you insert the SIM card, make sure that the car phone has been switched off!

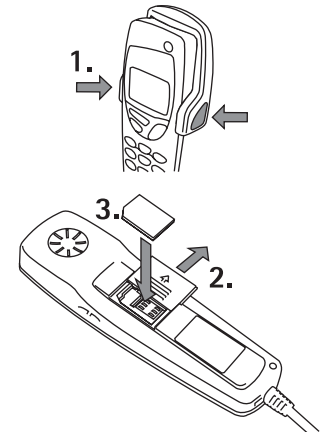

1. Press at least one push button of the cradle to lift off the handset.
2. At the back of the handset, push the cover for the SIM card aside.
3. Insert the SIM card and close the cover.



Using the keys

Navi key



The use of the phone is largely based on the Nokia Navi™ key , located below the display. The function of the Nokia Navi™ key  varies according to the guiding text shown above the key on the display.

Throughout this user's guide, the relevant guiding text is mentioned together with the Nokia Navi™ key, e.g.  (Menu) or  (Select).

Scroll keys

Scroll keys are used to browse through menus, submenus and settings and to move the cursor to the right or left.

With clear display, press  once to access the names and phone numbers stored in the Phone book.

With clear display, press  once to access the list of last-dialled numbers. During a call, press  to adjust the volume.

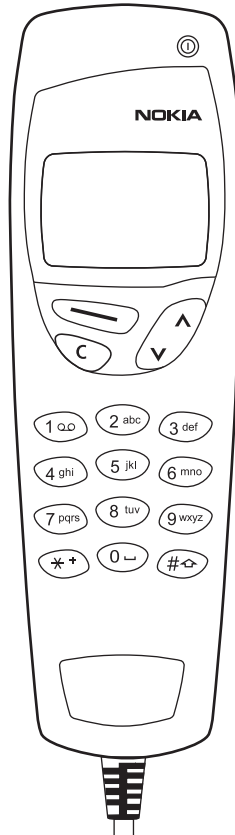

The clear key

- Use  to delete a character to the left of the cursor,
- to clear all the characters keyed in from the display (press and hold),
- to return from a submenu to the previous menu level in the menu facility,
- to exit the menu facility,
- to switch to handsfree,
- to activate options while you have a call in progress and
- to reject an incoming call.

Switching the car phone on and off

Warning! Do not switch on the car phone when wireless phone use is prohibited or when it may cause interference or danger.

Press and hold the  key for a second.

Note: Your car phone will not work unless sufficient battery power is supplied through your car battery.

If the handset asks for the PIN code

The PIN code protects your SIM card against unauthorised use and is usually supplied with the SIM card.

Note: Your car phone may have two different SIM cards: one card in the handset and one SIM card in the radio unit.

Key in the PIN code of the SIM card used (factory setting: SIM card of the handset), which is displayed as *****, and press  (OK), see "4-3-5 Change access codes" on page 29.



Note: If you enter an incorrect PIN three times in succession, the card is blocked and you have to re-enter the PIN using the personal unblocking key number (PUK), see "Access codes" on page 35.

Note: If your SIM card is lost or stolen, immediately inform your network operator or service provider to block the card and thus prevent any unauthorised use at your expense. As a rule, you will have to specify your name, the SIM card number and your subscriber's number.

If the handset asks for a security code

Key in the security code, which is displayed as ******, and press  (OK), see "About labels on your car phone" on page 8.





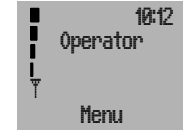

Note: If you take out the SIM card while the phone is in operation, information could be lost.

The display indicators

The indicators described below are shown when the car phone is ready for use, and no characters have been entered by the user. This is also called a "clear display".



- Operator** Indicates which cellular network the car phone is currently being used in. Depending on your SIM card, the name of the service provider may be shown in the next line.
-  Shows the signal strength of the cellular network at your current location: the higher the bar, the stronger the signal.
- 10:12** Shows the time.
-  Shows that you have received a short message.
-  Notifies divert of all voice calls.
-  Shows that the phone is in silent mode.

2. Basic Functions

Making a call

1. Key in the phone number including the area code. The text **Menu** changes to **Call**.

Correct keying mistakes by pressing  to delete the last character to the left.

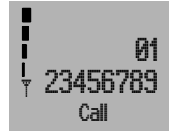

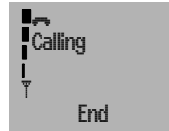

2. Press  (**Call**) and wait for the answer. The text **Call** changes to **End**.

3. Press  (**End**) to finish the call (or to cancel the call attempt).



International call

1. Press  twice for the international prefix (+ character replaces the international access code).
2. Enter the country code, the area code and the phone number.
3. To call the number, press  (**Call**).

Handsfree mode

When you are using the handset while it remains in its cradle, the phone automatically works in handsfree mode. You can switch from handsfree to private mode by picking up the handset. If you replace the handset on the cradle, the call is terminated.

To switch back to handsfree, first press  and then put the handset back in the cradle.

Receiving a call

When a call is put through to you, the phone will ring and flash either the caller's name or phone number or the text **calling**.

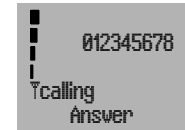

To answer the call, press  (**Answer**).



Note: If more than one name with the same last seven digits as the caller's phone number is found in the Phone book, only the caller's phone number is displayed if available.



To reject an incoming call, press . If the **Divert when busy** function is activated to divert the calls, e.g. to your voice mailbox, rejecting an incoming call will also divert the call, see "5 Call divert" on page 30.

If you select **Automatic answer** (see "4-1 Call settings" on page 27) your phone is set to automatically answer an incoming call after one ring.

Note: If you are using the handsfree mode, you do not have to take the handset out of its cradle. Lift the handset from its cradle only if you want to speak privately. If you put the handset back into its cradle, you will terminate the call!

Adjusting the volume

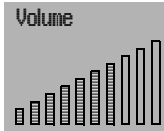

You can adjust the handset volume of the phone during a call. Press  to increase and  to decrease the volume level.

You can also adjust the handsfree volume of the phone during a call. Press  to increase and  to decrease the volume level.





Redialling last number

The last eight phone numbers you called or attempted to call are stored in the car phone's memory. To redial one of these last-dialled numbers,

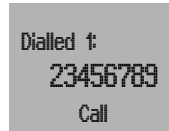

1. with display clear, press  once to access the list of the last-dialled numbers.
2. Use  to access the desired number.
3. Press  (Call).

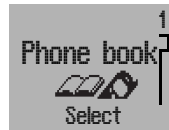

Storing a name and phone number in the Phone book

1. Press  (Menu) to access the menu facility.
2. With **Phone book** displayed, press  (Select).



3. Use  to access **Add entry** and press  (Select).



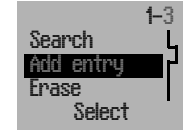



Name: prompt is displayed.



4. Key in the desired name as follows:



Press the key labelled with the character you want: press once for the first character, twice (before the cursor appears) for the second, etc.



The available character set depends on the selected language, see "4-2-1 Language" on page 27.

- Press a key  -  repeatedly to find characters, e. g.  for characters . , ? ! - & 1 and  gives a space,
-  switches between upper- and lower-case characters. The **ABC** or **abc** indicator is shown on the display.
- Press and hold  to switch between characters and numbers. The **ABC (abc)** or **123** indicator is shown on the display.
- You can also add a number by pressing and holding the appropriate number key for a second.

When the flashing cursor appears, you can enter the next character.

Press  to move the cursor.

Press  to call up a list of special characters. The  indicator is shown.

Use  to scroll to the desired character and press  (Use) to add it to the name.

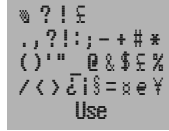

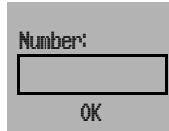

5. When you have written the name, press  (OK).

Number: prompt is displayed.





6. Key in the country code (if necessary), the area code and phone number.







Note: If you key in the + character for the international prefix (by pressing  twice) in front of the country code, you can use the phone number when calling from abroad.

7. Press  (OK). The name and phone number are stored in the Phone book.

Quick Save



With the display clear, key in the phone number, press  to change the Navi key text to **Save** and press  (Save). Key in the name and press  (OK).

Making a call using the Phone book

1. Press  (Menu).
2. With **Phone book** displayed, press  (Select).
3. Press  (Select) to choose **Search**.
4. Key in the first letter(s) of the name and press  (OK). You can skip this step if you like.
5. Use  to reach the desired name. You can check the phone number by pressing and holding .
6. Press  (Call).















A quick way to access the Phone book

With the display clear, press . The first name (and phone number) in Phone book are displayed.

Note: The names and phone numbers assigned to the speed dial keys 1 to 9 can be speed dialled via the number keys  to  and .

3. Other Essential Functions





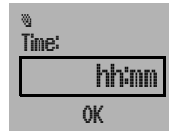



Setting the time

1. Press  (Menu) and use  to access **Clock** and press  (Select).
2. Use  to access **Clock settings**, press  (Select).
3. Use  to scroll to **Set the time** and press  (Select).
4. Key in the time, e.g. ,  ,  ,  for 8.30.
5. Press  (OK) to confirm. The time is displayed in the right-hand corner of the display.



Note: The car phone does not contain its own battery, therefore the setting will be lost if the voltage of the car battery is low.



Selecting a ringing tone

1. Press  (Menu).
2. Use  to access **Tones** and press  (Select).
3. Use  to access **Ringing tone** and press  (Select).
4. Use  to scroll to the ringing tone you prefer. The phone gives you a ringing sample. Press  (OK) to select it.
5. Press and hold  to exit the menu.

In-call options

Your phone provides a number of control functions that you can use during a call. You cannot utilise all of these functions at all times. Only those functions which are available and enabled will be shown in the in-call menu.

Many of the in-call options are network services.

While you have a call in progress, press  (Options) to enter the in-call menu. If the Navi key text is **End**, press  to activate the text **Options**.

The following in-call options may be available:

Hold or Unhold	to hold or release a call
New Call	to make a call during an on-going call
Answer	to answer the incoming call
Reject	to reject the incoming call
Swap	to switch between the two calls
End this call	to end the active call
Send DTMF	to send DTMF tones
Send	to send the character string on the display to the network
End all calls	to end both calls
Phone book	to enter the Phone book

To exit the in-call menu, press .

Voice messages

The network may offer you a voice mailbox service, which you have to install before you can receive voice messages. After you have installed this mailbox (refer to the user's guide supplied by your service provider), you can divert your calls to the voice mailbox and callers can leave you messages.

The network informs you when you have a voice message waiting. Call the mailbox number and listen to the message(s).

1. With clear display, press and hold  for a second to call your voice mailbox.

If the phone asks for the voice mailbox number, key it in and press **(OK)**, see "2-6 Voice mailbox number" on page 25. You will obtain your voice mailbox number from your service provider upon subscription to the voice mailbox service.
2. Listen to the messages. End the call by pressing  **(End)**.

Note: If the Navi key text **Listen** is available, press  **(Listen)** to call your voice mailbox.

Text messages









You can read, write and store short text messages of up to 160 characters' length.

Before you can send any messages, you need to store the number of your message centre in the memory of the SIM card. It will remain unchanged until replaced. You will be allocated a





number by your service provider upon subscription to the Short Message Service (SMS), see "2-4 Message settings" on page 24.

Make sure, before sending a text message, that the called party is provided with the SMS feature.

Reading messages

1. When you have received an SMS message, the text **Messages(s) Received** and the  indicator are displayed. Press  **(Read)**.
2. Use  to scroll to the desired message and press  **(Read)**.
3. While reading a message, use  to browse through the message. Press  **(Options)** for available options. Press  briefly to exit the message.
4. Press and hold  for a second to exit the menu.

Writing and sending a message

1. Press  **(Menu)**.
2. Use  to scroll to the menu function **Messages** and press  **(Select)**.
3. Use  to access **Write messages** and press  **(Select)**.

- Key in the message. For information on how to use the keys for writing, see "Storing a name and phone number in the Phone book" on page 13.

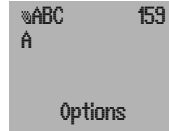

- When you have finished writing, press (Options).
- Select **Send** and press (OK) or select **Save** to store the message so that it may be sent later.
- Key in the recipient's phone number or press (Search) and use to search for it in the Phone book and press (OK).
- Press (OK) to send the message.
- Press and hold (C) twice to exit the menu.

Deleting messages

The storage capacity of the SIM card may vary depending on the card. If the SIM card is full, the indicator begins flashing. To store new messages, you have to delete those messages no longer required.

- Press (Menu) and scroll to **Messages**.
- Use to access **Inbox**.
- Press (Options) and delete the selected message.

Fax and data call

Your radio unit supports fax and data calls. For example, the radio unit may be connected to a compatible mobile fax machine or to a compatible laptop computer via an RS-232 connection. The RS-232 connector supports full protocol and 9 PIN standard (TIA/EIA-562). You have to select 19200 bps as RS-232 interface speed. For further information, see the Nokia 6090 webpage: <http://www.nokia.com>.

The transceiver is provided with a plastic cap to protect the data adapter connector. Remove the cap and then connect the terminal.

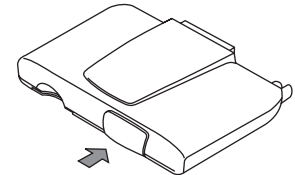







Warning! Keep the cap out of small children's reach! Always remove the cap whenever you may have small children in your vehicle.

Ignition sense

The ignition sense prevents the car phone from draining the car battery. The ignition sense enables the car phone to be switched on or off automatically whenever the car's ignition is switched on or off. However, you can switch the handset on or off at any time via (P).

Automatic power-off

Automatic power-off prevents the car phone from draining the car battery if the car phone is accidentally left on. You can set this function by selecting the length of the automatic power-off time.

1. Press  (Menu), use  to access the menu function **Settings** and press  (Select).
2. Use  to scroll to **Phone settings** and press  (Select).
3. Use  to scroll to **Automatic power-off** and select the option.

Note: If automatic power-off is disabled, the car phone don't switch itself off automatically.

Ignition sense is connected:

If automatic power-off is set to on and the ignition is turned off, the car phone switches itself off after the set time (45 sec. – 24 hours). The countdown time can be restarted by any user action, i.e. key press or replacement of handset.

Ignition sense is not connected:







If automatic power-off is set to on, the car phone is switched off within the set time after the last user action, i.e. a key press or replacement of the handset.

Note: If you have selected 45sec., you can postpone switching off for one hour by pressing  when the message is displayed.

Car radio mute

This feature mutes the car radio during a phone call, or during selecting of the ringing tones and of the volume and during SMS signalling, if the car radio mute cable is connected.

Backlight dimming

1. Press  (Menu).
2. Use  to access the menu function **Settings** and press  (Select).
3. Use  to scroll to **Phone settings** and press  (Select).
4. Use  to scroll to **Lights** and select an option:

Full brightness: Backlighting is always fully on.

Custom setting: Backlighting is adjusted to the brightness of the dash lighting (only if the cable for backlight dimming is connected).







Off: Lights are always off.

4. Using the Menu

The car phone allows you to alter and view the settings of the functions and options that are listed in the menus and sub-menus.



The menus and submenus can be accessed by scrolling or by using the appropriate shortcut.

Accessing the menus by scrolling

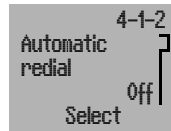
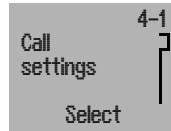
1. To access the menu facility, press  (Menu).
2. Press  to reach the desired main menu, e.g. **Settings**.
3. Press  (Select) to enter the menu.
4. If the menu contains any submenus, scroll to the desired one with .
5. Press  (Select) to enter the sub-menu (e.g. **Call settings**). If the menu contains submenus, repeat steps 4 and 5.
6. Press  to scroll to the setting of your choice.



7. Press  (OK) to confirm the chosen setting.

Note: You can return to the previous menu level by pressing  briefly or exit the menu without changing any of the settings by pressing and holding .

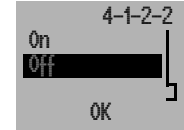

Accessing the menus by shortcut

The menu items (menus, submenus and setting options) are numbered and can be accessed via their shortcut number. This number is shown in the top right-hand corner of the display.

1. Press  (Menu).
2. Key in the number of the desired menu function you wish to access quickly, i.e. within three seconds.



For example, to set the keypad tones to off:

Press  (Menu),  (9 wxyz),  (5 jkl),  (1 abc),  (OK).

 (Menu) to enter the menu,

 (9 wxyz) for **Tones**,

 (5 jkl) for **Keypad tones** and

 (1 abc) for keypad tones **Off**.

Press  (OK) to confirm.

List of menu functions

1 Phone book

- 1 Search
- 2 Service Nos.
- 3 Add entry
- 4 Erase
 - 1 One by one
 - 2 Erase all
- 5 Edit
- 6 Copy
- 7 Send entry
- 8 Options
 - 1 Memory in use
 - 2 Type of view
 - 3 Memory status
- 9 Speed dials

2 Messages

- 1 Inbox
- 2 Outbox
- 3 Write messages
- 4 Message settings
 - 1 Set 1¹
 - 1 Message centre number
 - 2 Messages sent as
 - 3 Message validity

- 2 Set N²
- 3 Common
 - 1 Delivery reports
 - 2 Reply via same centre

- 5 Info service
 - 1 On
 - 2 Off
 - 3 Topic index
 - 4 Topics
 - 5 Language
- 6 Voice mailbox number

3 Call register





- 1 Missed calls
- 2 Received calls
- 3 Dialed numbers
- 4 Erase recent call lists

4 Settings

- 1 Call settings

-
- 1. The number of the settings depends on how many settings your SIM card offers. Each setting appears in its own submenu and may have any name.
 - 2. The shortcut number of this menu depends on the number of settings available.

- 1 Anykey answer
- 2 Automatic redial
- 3 Speed dialling
- 4 Call waiting options
- 5 Own number sending
- 6 Automatic answer
- 7 Phone line in use (only when ALS)
- 2 Phone settings
 - 1 Language
 - 2 Cell info display
 - 3 Welcome note
 - 4 Network selection
 - 5 Lights
 - 1 Full brightness
 - 2 Custom setting
 - 3 Off
 - 6 Automatic power-off
 - 1 Disabled
 - 2 45 sec.
 - 3 1h
 - ...
 - 26 24h
 - 7 SIM card priority
 - 1 Radio unit SIM
 - 2 Handset SIM
- 3 Security settings
 - 1 PIN code request
 - 2 Fixed dialling

- 3 Closed user group
 - 4 Phone security
 - 5 Change access codes
 - 1 Change security code
 - 2 Change PIN code
 - 3 Change PIN2 code
 - 4 Restore factory settings
- 5 Call divert** 
- 1 Divert all voice calls without ringing
 - 2 Divert when busy
 - 3 Divert when not answered
 - 4 Divert when phone off or no coverage
 - 5 Cancel all divers
- 6 Call counters** 
- 1 Show call duration
 - 1 Last call duration
 - 2 All calls' duration
 - 3 Received calls' duration
 - 4 Dialed calls' duration
 - 5 Clear timers
 - 2 Show call costs
 - 1 Last call cost
 - 2 All calls' cost
 - 3 Clear counters
- 3 Call cost settings
 - 1 Call costs' limit
 - 2 Show costs in
- 7 Calculator** 
- 8 Clock** 
- 1 Alarm clock
 - 2 Clock settings
 - 1 Show clock / Hide clock
 - 2 Set the time
 - 3 Time format
- 9 Tones** 
- 1 Incoming call alert
 - 2 Ringing tone
 - 3 Ringing volume
 - 4 Message alert tone
 - 5 Keypad tones
 - 6 Warning tones

1 Phone book



You can store phone numbers and their related names in the memory of your SIM card or your phone by using the Phone book menu.

The car phone supports SIM cards which can store up to 250 phone numbers (of up to 30 digits) and names (of up to 16 characters). The length and also the number of phone numbers and names which can be stored in the SIM card may vary depending on the SIM card.

1-1 Recalling a name and phone number from the Phone book

Use the menu function **Search** to see if the desired name and phone number are stored in the Phone book.

Note: By pressing , you can access the names and phone numbers stored in your Phone book more quickly.

1-2 Service numbers

If this service is provided, you can use this menu function for easy access to the service numbers of your service provider.

1-3 Storing a name and phone number in the Phone book

In this menu **Add entry**, you can store phone numbers and the related names.

1-4 Erasing a name and phone number from the Phone book

You can **Erase** phone numbers and names from the Phone book either **One by one** or by selecting **Erase all** if all the names and numbers are to be erased from the Phone book at one time.

1-5 Editing a name and phone number in the Phone book

In this menu, you can **Edit** the names and phone numbers stored in the Phone book.



1-6 Copying the Phone book

You can copy the Phone book to the additional storage component in the phone or to another SIM card. Use **From SIM card to phone** to copy the Phone book entries one by one or all together into your phone; **From phone to SIM card** copies the Phone book onto another SIM card.



1-7 Sending a name and phone number from Phone book

The menu function **Send entry** allows you to send a person's contact information, name and phone number ('business card'), from the Phone book to another phone.

Sending the contact information

Select **Send** entry, scroll to the name and number you want to send and press  (**Send**). Enter the recipient's phone number or search in the Phone book. Press  (**OK**) to send the information.

Receiving the contact information

When the phone receives contact information, the text **Business card received** is displayed. Press  (**Options**) to **Show**, **Save** or **Discard** the information and press  (**OK**).

1-8 Options

1-8-1 Selecting the Phone book used

Select the Phone book you want to use: the one on SIM card or the one stored in the phone.



1-8-2 Setting the type of viewing for stored names and phone numbers

There are three different ways the phone can show the stored phone numbers and names: **Name list** (shows three names at a time), **Name, number** (shows one name and phone number together) or **Large font** (shows one name at a time).

1-8-3 Checking the amount of free space in the Phone book

You can check how many names and phone numbers may still be stored and are currently stored in the Phone book.

1-9 Assigning a phone number as a speed dial number

You can assign nine phone numbers stored in the Phone book as speed dial numbers which can be dialled via the number keys  to .

Specifying a speed-dialling key



Select the menu function **Speed dials**. If no phone number is assigned to a key, press  (**Assign**).

Note: **Assign** is also shown when the phone has automatically assigned a phone number from the Phone book to a speed dialling key.

Search for the desired name and/or phone number in the Phone book and press  (**OK**) to select it.

If a phone number is assigned to a key, you can view the number, change it or erase it by first pressing  (**Options**).

Using the speed dialling key



Press the desired speed dialling key ( to ) briefly and press  (**Call**) to make the call.



Note: Pressing and holding  automatically calls your voice mailbox!



2 Messages



2-1 Inbox

When you have received an SMS message, the text **...Messages(s) received** is displayed and the  indicator is on. Press  (**Read**) to view the message(s). To view the message later, enter the menu function **Inbox**.

The messages in the **Inbox** are listed with the latest message at the top of the list. Use  to scroll to the desired message and press  (**Read**).

While reading a message, press  (**Options**) for available options, and press  (**OK**) to select the desired option: **Erase**, **Reply**, **Edit**, **Use number** (lists the phone numbers found in the message) and **Forward** (to forward the message). In the **Details** option, use  to see the details of the message: the sender's name and phone number, the message centre used for sending and the date and time the message was received.

2-2 Outbox

In the **Outbox** menu, you can find those stored messages to be sent at a later time.

2-3 Write messages

Within the **Write messages** menu, you can write and edit text messages of up to 160 characters.

When you have finished writing, press  (**Options**) for one of the options: **Send**, **Send by set** (sends the message by using a selected setting), **Save** (stores the message in the outbox folder to be sent later) or **Clear screen** (removes all the characters in the message).

2-4 Message settings

2-4-1 Set 1¹

A setting group or "set" is a collection of settings needed for sending text messages.

You can, for example, send a text message as a fax if this is supported by your service provider by simply selecting the set in which you have defined the proper settings for fax transmissions.

Each set has its own submenu:

2-4-1-1 Message centre number

Stores the phone number of the message centre needed for sending text messages. You obtain this number from your service provider. Key in the phone number of the message centre or edit the existing one and press  (**OK**).

2-4-1-2 Message sent as

You can request the network to convert your text messages into

1. The total number of settings depends on how many settings your SIM card offers.

Fax, Paging or E-mail format (network service).

In order to receive a converted message, the recipient must have an appropriate terminal device.

2-4-1-3 Message validity

This network service allows you to set the length of time your text messages are stored at the message centre while attempts are made to deliver them.

2-4-2 Set N

2-4-3 Common ¹

2-4-3-1 Delivery reports

You can request the network to send delivery reports on your text messages (network service).

2-4-3-2 Reply via same centre

You can request the network to route the reply to your text message via your own message centre (network service).

2-5 Info service

This network service allows you to receive messages on various topics (such as weather or traffic conditions) from your service provider. For available topics and relevant topic numbers, contact your service provider.

2-5-1 On

If you select **On**, you will receive messages on the active topics. You can edit the topic list and mark the topics active or inactive.

2-5-3 Topic index

This menu retrieves a list of available topics from the network.

2-5-4 Topics

Here you can **Add topic** to the topics list. Key in the topic number and name. You can also **Edit** or **Erase** the topic list. You can read the topics by selecting **Read**.

2-5-5 Language

Here you can select the language for the messages. Only messages in the selected language are shown.

2-6 Voice mailbox number

Using the menu **Voice mailbox number**, you can store the number of your voice mailbox. Key in the number and press  (OK). The number will remain unchanged until replaced. You are assigned the number by your service provider.

1. The shortcut number of this menu depends on the number of sets available.

3 Call register



The phone registers missed and received calls only if the network supports the Calling Line Identification function, if the phone is switched on and if it is within the network's service area.

3-1 Missed calls

The last five phone numbers of the calling parties who have tried to call you are stored in the phone's memory in the missed calls list.

In the options of the **Missed calls** menu, you can view the phone number, **Call** the number, view the **Time of** the missed call if the clock is set to the right time, **Edit number** and **Save** it in the Phone book or **Erase** the phone number.

Note: When a notice about missed calls appears on the display, press  (**List**) to view the list of missed call phone numbers.

3-2 Received calls

The last five phone numbers from which you have received a call are stored in the phone's memory in the received calls list.

In the options of the **Received calls** menu, you can view the phone number, **Call** the number, view the **Time of** the received call if the clock is set to the right time, **Edit number** and **Save** it in the Phone book or **Erase** the phone number.

3-3 Dialed numbers

The phone stores the last eight phone numbers that you called or attempted to call.

In the options of the **Dialed numbers** menu, you can view the phone number, **Call** the number, view the **Time of** the call if the clock is set to the right time, **Edit number** and **Save** it in the Phone book or **Erase** the phone number.

3-4 Erasing recent call lists

This menu function allows you to erase all the phone numbers and names in the missed calls, received calls and dialed numbers lists.

Note: If the SIM card is renewed, the contents of the missed calls, dialed numbers and received calls lists are erased.

4 Settings



4-1 Call settings

4-1-1 Anykey answer

This menu function allows you to answer your incoming calls by pressing any key except **C** and **Ⓢ**.

4-1-2 Automatic redial

When this menu function is set to **On**, your phone will make up to ten attempts to connect the call after an unsuccessful call attempt.

4-1-3 Speed dialling

When this menu function is set to **On**, you can apply one touch dialling. The names and phone numbers assigned to the speed dialling keys **2 abc** to **9 wxyz** can be dialled by pressing and holding the corresponding number key.

Note: Pressing and holding **1 ca** dials your voice mailbox number, not the speed dial number assigned to the key.

4-1-4 Call waiting options

When this network service is activated, the network will notify you of a new incoming call while you have a call in progress.

4-1-5 Own number sending

This network service allows you to set whether your phone number is hidden or to be displayed to the person you are calling. **Preset** resets the phone to the default setting, **On** or **Off**, that you have agreed upon with your service provider.

4-1-6 Automatic answer

When this setting is **On**, your phone is set to automatically answer an incoming call after one ring.

4-1-7 Phone line in use (only when ALS)

Alternate Line Service is a feature of your SIM card. With this menu, the car phone displays the currently used phone number.

4-2 Phone settings

4-2-1 Language

You can select which language your phone will use for all its display texts. If the setting **Automatic** is selected, the phone will set the language according to the information contained in the SIM card used in the phone. English is used as a default setting if the language on the SIM card is not found in the phone.

4-2-2 Cell info display

Within this menu, you can set the phone to indicate if it is used in a cellular network based on Micro Cellular Network (MCN) technology (network service).

4-2-3 Welcome note

This menu allows you to set the message which is displayed when the phone is switched on.

4-2-4 Network selection

The network can be selected automatically or manually.

In **Automatic** mode, the phone automatically selects one of the cellular networks available in your area.

In **Manual** mode, the phone shows a list of available networks and you may select the desired network if this network has a roaming agreement with your home network operator. Otherwise the text "**No access**" is displayed and another network must be selected. The phone remains in manual mode until the automatic mode is selected or until another SIM card is inserted in the phone.

4-2-5 Lights

You can dim the lights of the display and the keypad as desired.

4-2-5-1 **Full brightness** means that backlighting is fully on.

4-2-5-2 **Custom setting** means that backlighting of the car phone is adjusted to the brightness of the dash lighting. This setting only works if the cable for backlight dimming is connected when the car phone is installed.

4-2-5-3 **Off** means that the lighting remains off.

4-2-6 Automatic power-off

Automatic power-off prevents the car phone from draining the car battery if the car phone is accidentally left on. You can set this function to **Disabled** or set the length of the automatic power-off time between 45 sec. and 24 hours.

4-2-7 SIM card priority

4-2-7-1 Radio unit SIM

The SIM card in the radio unit is assigned priority.

4-2-7-2 Handset SIM

The SIM card in the handset is assigned priority.

4-3 Security settings

Your phone is equipped with a versatile security system to prevent unauthorised use of the phone or the SIM card. The codes queried are those valid for the prioritised SIM card.

4-3-1 PIN code request

Within this menu, you can set the phone to ask for the PIN code of your SIM card when the phone is switched on. You need the PIN code to set the request to on.

Note: Remember that some SIM cards do not allow the PIN code request to be turned off.

4-3-2 Fixed dialling

You can restrict your outgoing calls to selected phone numbers, if this function is supported by your SIM card. To save and edit numbers on the list, you need the PIN2 code.

Note: When **Fixed dialling** is set to **On**, calls may be possible to certain emergency numbers in some networks (e.g. 112 or other official emergency numbers).

4-3-3 Closed user group

This network service specifies the group of people whom you can call and who can call you. **Reset** resets the phone to deploy any user group the SIM card owner has agreed upon with the service provider.

Note: When calls are limited to closed user groups, calls may be possible to certain emergency numbers in some networks (e.g. 112 or other official emergency numbers).

4-3-4 Phone security

This menu allows you to set the phone security level to **On** in order to prevent unauthorised use of the phone. You need the security code to set the security level.

If **On** is selected, the phone will ask for the security code whenever a new SIM card is inserted.

Note: If you change the security level, all the recent calls lists are cleared.

4-3-5 Change access codes

With this menu, you can change the access codes: security code, PIN code and PIN2 code of the active SIM card. These codes may only include the characters 0 to 9. The phone prompts you to enter the current code and the new code. It also prompts you to verify the new code.

If you want to change the codes of the second SIM card, you have to change the priority of the card reader, see "4-2-7 SIM card priority" on page 28, restart the car phone and change the codes of the second SIM card.

Note: Avoid using access codes similar to the emergency numbers, such as 112, in order to prevent accidental dialling of the emergency number.

4-4 Restore factory settings

You can reset some of the menu settings to their original values. The security code is needed for this function.

5 Call divert



The call divert network service allows you to divert the incoming calls to your voice mailbox (only voice calls) or to another phone number. The following call divert modes are available:

5-1 Divert all voice calls without ringing

5-2 Divert when busy

5-3 Divert when not answered

5-4 Divert when phone off or no coverage.

Then you can **Activate**, **Cancel** or check the **Status** of the selected mode. For some divert modes, **Set delay** is available.

5-5 With **Cancel all divers**, you can set all divers to off.

Note: If **Divert when busy** is activated, rejecting an incoming call will also divert the call.

6 Call counters



Note: The actual invoice for calls and services from your service provider may vary, depending upon network features, rounding-off for billing, taxes and so forth.

6-1 Show call duration

You can use the **Show call duration** menu to view the approximate duration of your outgoing and incoming calls in hours, minutes and seconds and to reset the call timers to zero.

Inserting a new SIM card does not clear the call timers.

6-2 Show call costs

This network service allows you to check the approximate cost of your last call or of all calls if the call cost service is supported by the network. The costs are shown in terms of charging units. Call costs are shown separately for each SIM card.

6-3 Call cost settings

6-3-1 Call costs' limit

This network function allows you to set a cost limit for the calls with your SIM card. You can make and receive charged calls as long as the set call cost limit is not exceeded. The limit can be set in a specified number of charging units or units of the currency set within the **Show costs in** menu.

Depending on the SIM card used, you may need the PIN2 code to set a call cost limit.

6-3-2 Show costs in

This network function allows you to select whether the call costs are displayed in terms of charging units or the desired currency. Contact your service provider for the charging unit prices.

Depending on the SIM card used, you may need the PIN2 code to select the currency or unit in **Show costs in**.

7 Calculator



The phone is provided with a basic four-function calculator, which can also be used for rough currency conversions.

Using the calculator

Enter the first numbers in the calculation using the - keys. Press for a decimal point (.).

Press once (+) to add, twice (-) to subtract, three times (\times) to multiply and four times (\div) to divide, or press (**Options**) to access the desired function.

For a total, press (**Options**) and select **Equals** using (**OK**). Press to clear the display.

Note: This calculator has a limited accuracy and rounding errors may occur, especially in long division.

Making a currency conversion

1. Press (**Options**) and select **Exchange rate**.
2. Choose either of the displayed options: **Foreign unit expressed as domestic units** or **Domestic unit expressed as foreign units**.
3. Key in the exchange rate (press for a decimal point) and press (**OK**).
4. **Make the conversion:** Key in the amount to be converted, press (**Options**) and select **To domestic** or **To foreign**.

Warning! Your phone must be switched on to use this function. Do not switch the phone on when wireless phone use is prohibited or when it may cause interference or danger.

8 Clock



8-1 Alarm clock

The phone can be set to ring as an alarm at a specified time. The alarm clock uses the time format set for the clock: a 12-hour cycle or a 24-hour cycle.

Note: If the phone is switched off, the alarm clock will not work.

In this menu, you can set the alarm time or select **On** to change the alarm time or **Off** to turn off the alarm clock.

When the set alarm time expires

The timer alert tone corresponds to the ringing volume setting. However, only a beep is heard, if you have selected **Off** or **Beep once** in the **Tones** menu.

When the phone alarm goes off, the message **Alarm!** is shown and the lights flash. If you let the phone alarm run for a minute or if you press  (**Snooze**), the alarm stops for a few minutes and then re-sumes ringing. Press any other key to stop the alarm.

8-2 Clock settings

The phone is provided with a real-time clock. Since the phone has no power backup, you may need to set the time again if the car battery is flat or has been removed.

In this menu, you can **Show / Hide clock**, **Set the time** or select the 12-hour or 24-hour **Time format**.

9 Tones



9-1 Incoming call alert

This menu function allows you to select how the phone notifies you of an incoming call. Available options are **Ringing**, **Ascending**, **Ring once**, **Beep once** or **Off** if no ringing tone is to be heard.

Note: If the phone is set to **Off**, no ringing tone, message alert tone, keypad tone or warning tone will be sounded.

9-2 Ringing tone

You can select any of the ringing tone types available in this menu.

9-3 Ringing volume

A ringing tone is set off when there is an incoming call. This menu function allows you to select any of the ringing volume levels available. The ringing tone volume set also affects the volume of the message alert tone.

9-4 Message alert tone

You can also select an alert tone to indicate an incoming SMS message.

9-5 Keypad tones

A tone is sounded each time a key is pressed. You can set the keypad tone to **Off** or select any of the three keypad tone levels available.

9-6 Warning tones

If this function is set to **On**, the notification tones of the phone sound.

5. Reference Information

Facts about cellular transmission

Your car phone employs the data transmission capabilities of the GSM network to send faxes, short messages and e-mail and to establish connections with remote computers.

GSM data capabilities of your car phone

- Data compression with V.42bis
- Non-transparent and transparent data transfer at 9.6kbit/s
- AT commands
(for further information, see webpage: www.nokia.com)
- Fax service classes 1, 2 and 2.0 and ECM (sending)
- SMS sending and receiving

Cellular data connections can be made from most of the locations where your car phone operates. However, we recommend that you move the car to a location where the strongest possible cellular signal can be obtained. When the signal is strong, data transmission is efficient.

In general, you should not expect the same performance from cellular data communications as from line-connected communications due to the inherent characteristics of the cellular environment. The following factors may impair cellular connections:

Noise

Radio interference from electronic appliances and equipment as well as from surrounding traffic may impact the transmission quality.

Handover

As the car phone user moves from one network cell to another, the signal strength of the channel drops and the cellular telephone exchange may hand the user over to a different cell and frequency where the signal is stronger. A cell handover may also occur when the user is stationary due to varying cellular traffic loads. Such handovers may cause slight delays.

Dead spots and dropouts

Dead spots are areas where radio signals cannot be received. Dropouts occur when the car phone user passes through an area where the radio signal is blocked or reduced by geographic or structural obstructions.

Low signal strength

Due to either distance or obstacles, the radio signal strength from a cell site may not be strong or stable enough to provide reliable cellular connection for communication. Therefore, to ensure the best possible communication, remember to take the following points into consideration when using your car phone:

The data and fax connection works best when the car is stationary. Attempting cellular communication while in a moving vehicle is not recommended. Fax transmission is more easily impaired than data or short message transmission.

Check that the cellular signal strength on the handset display is sufficient. If the cellular signals are not strong enough to support a voice call, data connection should not be attempted until you can find a location with better signal reception.

Environmental impacts

Your car phone works in an temperature range between -20°C and +60°C.

Access codes

You can use the access codes described in this section to prevent unauthorised use of your phone and SIM card.

Your car phone may contain two different SIM cards. These cards use different access codes. Remember to check which SIM card is currently in use.

The access codes (except PUK and PUK2 codes) can be changed by using the menu "4-3-5 Change access codes" on page 29. If you want to change the codes of the second SIM card, you have to change the priority of the card reader, see "4-2-7 SIM card priority" on page 28, restart the car phone and change the codes of the second SIM card.

Security code (5 digits)

The security code can be used to prevent unauthorised use of your phone. The security code (factory setting: 12345) is usually supplied with the phone.

Change the code, see "4-3 Security settings" on page 28, and keep the code secret and in a safe place separate from the phone.

PIN code (4 to 8 digits)

The PIN (Personal Identification Number) code protects your SIM card against unauthorised use. The PIN code is usually supplied with the SIM card.

PIN2 code (4 to 8 digits)

The PIN2 code, supplied with some SIM cards, is required to access some functions, such as call cost limit. These functions are only available if supported by your SIM card.

PUK code (8 digits)

The PUK (Personal Unblocking Key) code is required to change a blocked PIN code. The PUK code may be supplied with the SIM card. If not, contact your local service provider for the code. If you lose the code, contact your service provider.

PUK2 code (8 digits)

The PUK2 code, supplied with some SIM cards, is required to change a blocked PIN2 code. If you lose the code, contact your service provider.

Battery information

Your radio unit does not contain its own battery. The voltage is supplied straight from your car battery to the car phone. The car phone works with a voltage from 10.8V to 16V.

If the voltage is higher than 16V, the car phone switches off automatically and remains off until the voltage drops to a value within the permissible range.

If the voltage of the car battery drops lower than 10.8V, a warning appears that phone calls are not possible because of low power. If the voltage drops below approx. 6V, the phone switches off and will automatically switch on as soon as the voltage rises again. The next time the car phone is turned on, a message appears on the display giving the reason for the error.

Accessories

Warning! Use only accessories approved by the phone manufacturer for use with this particular phone model. The use of any other types will invalidate any approval or warranty applying to the phone, and may be dangerous.

6090 DIN/ISO installation kit

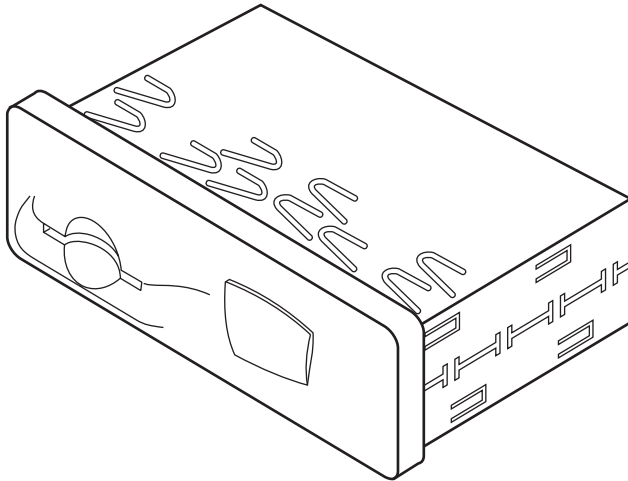

With the DIN/ISO installation kit, the Nokia 6090 is optimally designed for easy installation in your car, either in the dashboard or in the central console. You have easy access to the ra-

dio unit SIM reader or the data connector. For availability of approved accessories, please check with your dealer.

Warning! When you disconnect the power cord of any accessory, grasp and pull the plug, not the cord.

Care and Maintenance

Your car phone is a product of superior design and craftsmanship and should be treated with care. The suggestions below will help you to fulfil any warranty obligations and to enjoy this product for many years. When using your car phone or any accessory:

- Keep it and all its parts and accessories out of small children's reach.
- Keep it dry. Precipitation, humidity and liquids contain minerals that may corrode electronic circuits.
- Do not use or store it in dusty, dirty areas. Its moving parts can be damaged.
- Do not attempt to open it. Non-expert handling of the device may damage it.
- Do not drop, knock or shake it. Rough handling can break internal circuit boards.
- Do not use harsh chemicals, cleaning solvents or strong detergents to clean it. Wipe it with a soft cloth slightly dampened in a mild soap-and-water solution.
- Do not paint it. Paint can clog the device's moving parts and prevent proper operation.

- If the car phone is not working properly, take it to your nearest qualified service facility. The personnel there will assist you and, if necessary, arrange for service.

Important Safety Information

Traffic safety

Do not use a handheld telephone while driving a vehicle. If using a handheld telephone park the vehicle before conversing. Always secure the phone in its holder; do not place the phone on the passenger seat or where it can break loose in a collision or upon a sudden stop.

The use of an alert device to operate a vehicle's lights or horn on public roads is not permitted.

Remember road safety always comes first!

Operating environment

Remember to follow any special regulations in force in any area and always switch off your phone whenever it is forbidden to use it, or when it may cause interference or danger.

When connecting the phone or any accessory to another device, read its user's guide for detailed safety instructions. Do not connect incompatible products.

As with other mobile radio transmitting equipment, users are advised that for the satisfactory operation of the equipment and for the safety of personnel, it is recommended that the equipment should only be used in the normal operating position.

Electronic devices

Most modern electronic equipment is shielded from radio frequency (RF) signals. However, certain electronic equipment may not be shielded against the RF signals from your car phone.

Hearing aids

Some digital wireless phones may interfere with some hearing aids. In the event of such interference, you may want to consult your service provider.

Other medical devices

Operation of any radio-transmitting equipment, including cellular phones, may interfere with the functionality of inadequately protected medical devices. Consult a physician or the manufacturer of the medical device to determine if your devices are adequately shielded from external RF energy or if you should have any questions.

Switch off your car phone in health care facilities when any regulations posted in these areas instruct you to do so. Hospitals or health care facilities may be using equipment that could be sensitive to external RF energy.

Vehicles

RF signals may affect improperly installed or inadequately shielded electronic systems in motor vehicles (e.g. electronic

fuel injection systems, electronic anti-skid (anti-lock) braking systems, electronic speed control systems, airbag systems).

Check with the manufacturer or their representative regarding your vehicle. You should also consult the manufacturer of any equipment that has been added to your vehicle.

Posted facilities

Switch your car phone off in any facility where posted notices require you to do so.

Potentially explosive atmospheres

Switch off your car phone when in any area with a potentially explosive atmosphere and obey all signs and instructions. Sparks in such areas could cause an explosion or fire resulting in bodily injury or even death.

Users are advised to switch off the car phone when at a refueling point (service station). Users are reminded of the need to observe restrictions on the use of radio equipment in fuel depots (fuel storage and distribution areas), chemical plants or where blasting operations are in progress.

Areas with a potentially explosive atmosphere are often, but not always, clearly marked. They include below-deck on boats, chemical transfer or storage facilities, vehicles using liquified petroleum gas (such as propane or butane), areas where the air contains chemicals or particles, such as grain, dust or metal

powders and any other area where you would normally be advised to turn off your vehicle engine.

Vehicles

Only qualified personnel should service or install the car phone in a vehicle. Faulty installation or service may be dangerous and may invalidate any warranty which may apply to the unit.

Check regularly that all car phone equipment in your vehicle is mounted and operating properly.

Do not store or transport flammable liquids, gases or explosive materials in the same compartment as the car phone, its parts or accessories.

For vehicles equipped with an airbag, remember that an airbag inflates with great force. Do not place objects, including both installed or portable wireless equipment in the area over the airbag or in the airbag deployment area. If in-vehicle wireless equipment is improperly installed and the airbag inflates, serious injury could result.



Failure to observe these instructions may lead to suspension or denial of telephone services to the offender or legal action or both.

Emergency calls

Important! This car phone, like any wireless phone, operates using radio signals, wireless and landline networks as well as user-programmed functions which cannot guarantee connection in all conditions. Therefore, you should never rely solely upon any wireless phone for essential communications (e.g. medical emergencies).

Remember, to make or receive any calls, the car phone must be switched on and in a service area with adequate signal strength. Emergency calls may not be possible on all wireless phone networks or when certain network services and/or phone features are in use. Check with local cellular service providers.

To make an emergency call:

1. If the phone is not on, switch it on.
Some networks may require that a valid SIM card is properly inserted in the phone.
2. Press and hold  for several seconds to ready the phone for calls.
3. Key in the emergency number applicable for your present location (e.g. 112 or other official emergency number). Emergency numbers vary according to location.
4. Press  (Call).

If certain features are in use (Fixed dialling, etc.), you may first need to turn those features off before you can make an emer-

gency call. Consult this document and your local cellular service provider.

When making an emergency call, remember to give all the necessary information as accurately as possible. Remember that your wireless phone may be the only means of communication at the scene of an accident - do not cut off the call until given permission to do so.

Installation

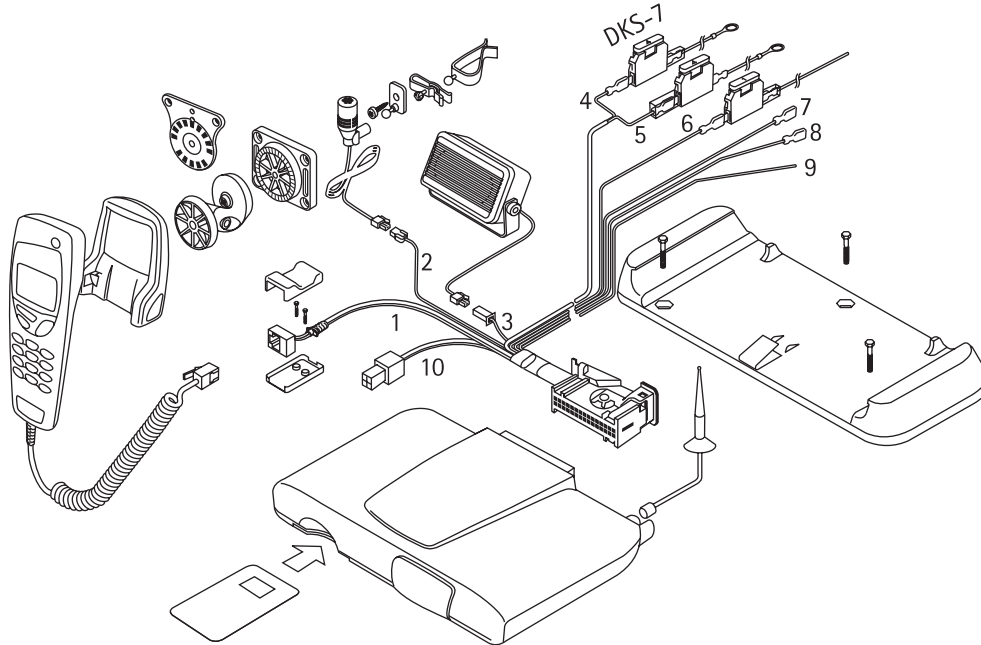

Cable connections

1. Handset
2. RF microphone
3. RF loudspeaker
4. Car battery + (with 3A fuse), 2 x red
5. Car battery - (with 3A fuse), 2 x black
6. Ignition sense (with 1A fuse), blue
7. Car radio mute, yellow
8. Antenna motor control, orange
9. Backlight dimming, grey
10. Audio line out, black cable:

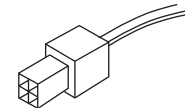

Recommendations for the installation of the Nokia 6090

Warning! Only qualified personnel should service the car phone or install the car phone in a vehicle. Faulty installation or service may be dangerous and may invalidate any warranty which may apply to the unit.

Note: When installing the car kit in Australia and New Zealand, the 6090 should be installed in accordance with AS/NZS 4346.

- **Microphone installation**

The recommended position for the microphone should be the top of the A-pillar or, alternatively, near the back mirror in the middle of the car. The microphone should be pointed in the direction of the driver's mouth with a optimum distance of 30 cm. Streams of fresh air should not be directed at the microphone and the microphone cable should not be laid in the ventilation system. Use the provided soft material to connect the HF microphone to the A-pillar in order to avoid any noise coupling from the car to the microphone.

- **Loudspeaker installation**

The best position for the RF speaker is in the lower front-seat passenger area.

- **Audio line out**

Handsfree can also be provided by using the audio line out signal of the 6090 in combination with an appropriate FM car radio supporting the audio line-in function which enables use of the car loudspeaker system instead of using the delivered handsfree loudspeaker HFS-10. For good performance, use the front loudspeaker only and adjust the volume via the 6090 handset. So that keypad and warning tones may be

audible, the external handsfree loudspeaker also has to be installed as described above. In case the FM car radio is not equipped with a connector for the audio line-out signal (see picture), the connector may be removed in order that the two wires can be directly connected to the FM car radio line-in. Since the 6090 audio line-out provides a differential signal instead of a +/- signal, the wires may be connected either way.

Warning! Don't connect the handsfree loudspeaker cable to the FM radio line-in. You might destroy the FM radio. Always use the audio line-out cable provided!

- **Connection to the car battery**

Take the voltage directly from the car battery and use the cable supplied with the sales packages. This cable includes fuses to protect the phone. If you do not so, noise may impact the quality of the 6090 loudspeaker. The description of the cable and its colour may be taken from the attached illustration.

- **GSM antenna**

Note: It's not recommended to use any combined GSM-phone/FM-radio antennas. Normal combined antennas might not be designed for 8 Watt output power of the GSM phone. The frequency switch of the antenna maybe destroyed and the FM-radio reception quality might suffer. Always use a separate GSM900 antenna.

- Connect only the 6090 handset to the system connector as shown in the installation picture.
- When installing the radio unit, ensure a sufficient air supply (e.g. not in a box under the carpet).
- Do not extend the system cable by any wires.
- Use only correct fuses.

Glossary

Alternate line service (ALS)

Alternate line service allows you to have two different phone numbers, which page the same SIM card. Each of these phone numbers can have different settings: call barrings, diverts, etc. This is a network service which has to be subscribed to separately with your service provider. These two phone numbers are handled as separate numbers in the network. They are invoiced separately and can be used, for example, for differentiating between personal and business calls.

Car data

Car data includes data that contains the essential information about your car. This information is required in emergency situations.

Data centre number

This number is needed when your phone has been connected to a laptop PC via an RS232-cable and you want to make data calls.

DTMF (Dual Tone Multi-Frequency) tones

DTMF tones are the tones you hear when you press the number keys on the phone keypad. DTMF tones allow you to communi-

cate with voice mailboxes, computerised telephony systems, etc.

PIN (Personal Identity Number) code

The PIN code protects your phone from unauthorised use. The PIN code is supplied with the SIM card. If the PIN code request is set to on, the code is required each time the phone is switched on. The PIN code must be 4 to 8 digits long.

PIN2 code

The PIN2 code is supplied with some SIM cards. The PIN2 code is required to access certain functions supported by the SIM card. The length of the PIN2 code is 4 to 8 digits.

PUK (PIN Unblocking Key) code

The PUK is an 8-digit code supplied with the SIM card. The code is required should you desire to change a disabled PIN code. If you enter an incorrect PUK code ten times in succession, the SIM card is rejected and you cannot make or receive any calls, except emergency calls. If the SIM is rejected, you will need a new SIM card.

You cannot change the PUK code. If you lose the code, contact your network operator.

PUK2 code

The PUK2 code is supplied with some SIM cards. The code is required when you wish to change a disabled PIN2 code. If you en-

ter an incorrect PUK2 code ten times in succession, you will not be able to access the functions which require the PIN2 code. To use these functions again, you will need to obtain a new SIM card from your network operator.

You cannot change the PUK2 code. If you lose the code, contact your network operator.

Security code

The security code is supplied with the car phone on an identification sticker (factory setting: 12345). The security code protects your car phone against unauthorised use.

Change the code, see "4-3-5 Change access codes" on page 29, and keep the new code secret and in a safe place, separate from the car phone.

SIM (Subscriber Identity Module) card

The SIM card contains all the information the cellular network needs to identify the network user. The SIM card also contains security-related information.

The Nokia 6090 contains two SIM cards: one in the handset, a plug-in SIM card, and a larger one in the phone unit: the IC-1 card. The cards differ solely in size.

SMSC number

Short message centre number is needed for sending of short messages. You have to save this number in **Message settings**.

Voice mailbox

A voice mailbox is a network service or a personal answering machine where people can leave you voice messages.

Index

- A**
- Access Codes 35
 - PIN code 35
 - PIN2 code 35
 - PUK code 35
 - PUK2 code 36
 - Security code 8, 35
 - Accessories 37
 - Alarm clock 32
 - Anykey answer 27
 - Automatic
 - Answer 27
 - Power-off 18
 - Redial 27
- B**
- Backlight dimming 18
 - Battery information 36
- C**
- C key 10
 - Calculator 31
 - Call
 - Counters 30
 - Divert 30
 - Emergency call 41
 - Fax and data call 17
 - Handsfree 12
 - In-call options 15
 - International call 12
 - Making a call 12
 - Missed calls 26
 - Receiving a call 12
 - Register 26
 - Car radio mute 18
 - Care and maintenance 38
 - Clock 32
 - Alarm clock 32
- D**
- Display indicators 11
- E**
- Emergency call 41
- F**
- Facts about cellular transmission .. 34
 - Fax and data call 17
- G**
- Glossary 44
- H**
- Handsfree mode 12
- I**
- Ignition sense 17
 - In-call options 15
- Installation** 42
- International call** 12
- K**
- Keys 10
 - C key 10
 - Navi key 10
 - Scroll keys 10
- L**
- Labels on your car phone 8
 - Lights 28
- M**
- Menu 19
 - 1 Phone book 22
 - 2 Messages 24
 - 3 Call register 26
 - 4 Settings 27
 - 5 Call divert 30
 - 6 Call counters 30
 - 7 Calculator 31
 - 8 Clock 32
 - 9 Tones 32
 - Accessing the menu by scrolling . 19
 - Accessing the menu by shortcut . 19
 - List of menu functions 20
 - Messages 24
 - Deleting messages 17
 - Reading messages 16

-
- Text messages 16
 - Voice messages 16
 - Writing and sending messages ... 16
 - N**
 - Navi key 10
 - O**
 - One touch dialling 27
 - P**
 - Phone book 22
 - Making a call using the Phone book
14
 - Quick save 14
 - Storing in the Phone book 13
 - PIN code 35
 - PIN2 code 35
 - PUK code 35
 - PUK2 code 36
 - R**
 - Radio unit 9
 - Redialling 13
 - Reference information 34
 - Ringing tone 32
 - S**
 - Safety information 7, 39
 - Scrolling 10
 - Security code 35
 - Settings 27
 - Signal strength 11
 - SIM card 9
 - Inserting a SIM card 9
 - Priority 28
 - Speed dialling 23
 - T**
 - Text messages 16
 - Time
 - Clock 32
 - Setting of the time 15
 - Tones 32
 - Selecting of the ringing tone 15
 - U**
 - Using this guide 8
 - V**
 - Voice mailbox 25
 - Voice messages 16
 - Volume 13