

Options Menu

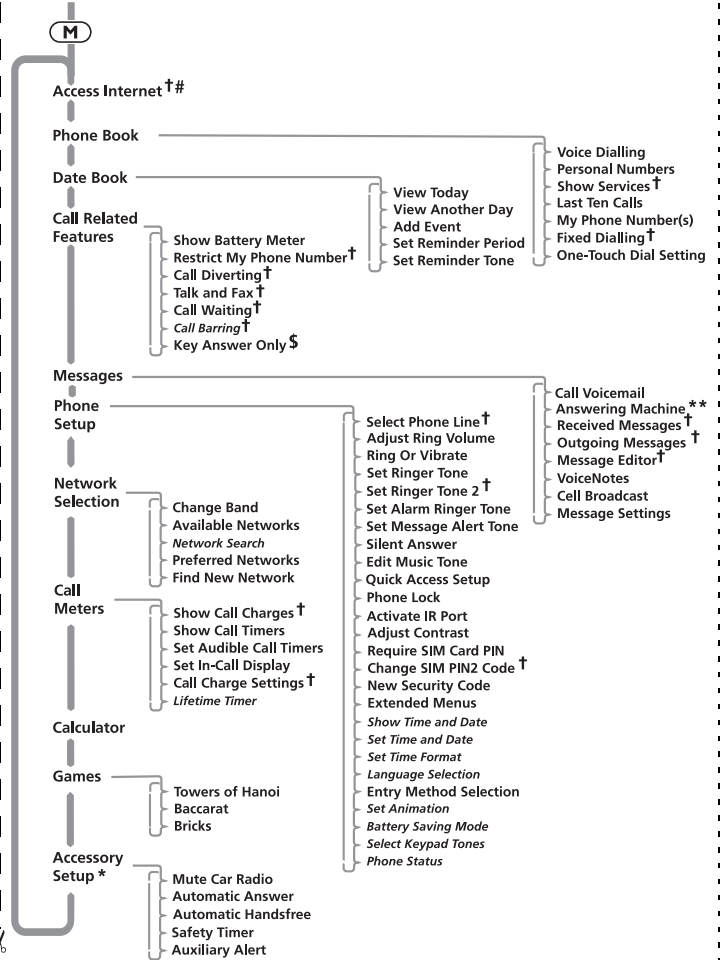

Quick Access†

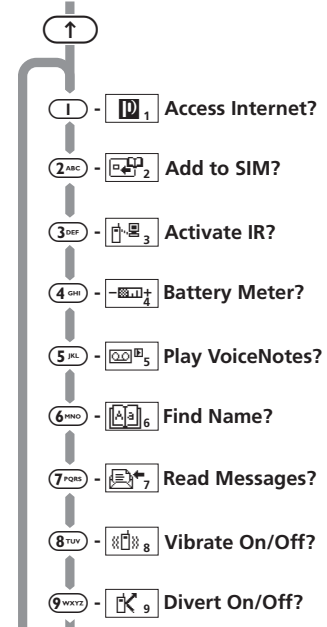

Menu Navigation

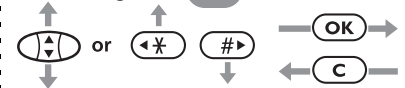

Items shown in ***Italics*** are available only when **Extended Menus** are switched on.

If your service provider has added their own menu, Access Internet will not be the first item in the Options menu.

† Availability depends on the type and settings of the SIM card and/or your subscription to these services where available.

* The **Accessory Setup** option is available only when a car kit or headset accessory are fitted.

‡ The features and the positions of the features in the Quick Access menu can be changed.

\$ Only on phones with a flip.

**This feature is not available in all countries









Quick Reference

English

Quick Reference

English

Special Keys

-  Press to turn phone on and off.
-  Press to accept call, setting, option,...
-  Press to reject call, setting, option,...
-  Press to enter the Quick Access features.
-  Press to access the options or phone book menus.
-   Press both simultaneously to lock the keypad on flipless models; also use to scroll left and right.
-  Pull down to scroll forwards and push up to scroll backwards.
-  Press to call Voicemail.

Making a Call

Enter **Phone No.** .

Receiving a Call

Press .



Ending a Call

Press  or .

Making an Emergency Call

Enter    . The call will be directed to a central emergency operator.

Quick Access Features

Press  followed by the appropriate key, or press , scroll to the feature and press  to select.

Adjust Ringer Volume

Press  followed by the volume button to either increase or decrease the ringer volume.



Recording a VoiceNote™

Press the Start/Stop Record button () on the top of the phone. Press the button again to stop recording.

Playing a VoiceNote™

Select Messages, VoiceNote™, Play VoiceNotes™, or use the Quick Access item.



Redialling the Last Number Called

- 1 Press  to display the last number dialled (Made Calls).
- 2 Press  to call the number.
- 3 Select Call Number and press .

One-Touch Dialling

Press and hold the appropriate digit key  to .

Recalling a Number from the Phone Book

Press the Smart button () and then use the volume button to scroll to the stored number, or press the appropriate digit key to skip to a particular letter. To make the call, either hold down  for 1.5 seconds or press .

Dialling Phone Book Numbers

Enter **Location**  .

Stopping a Call Alert

Press the volume button when the phone is ringing or vibrating. This will stop the alert but not answer the call.



Voice Dialling

Press the Smart button (Ⓢ). If there is a Phone Book entry with a Voice Tag the prompt *Say Name After Tone...* appears. Wait for the tone to finish and then say the name associated with the number you want to call.

Quick Reference

English

Quick Reference



English

Introduction

Welcome

Congratulations on your purchase of a mobile phone from *Motorola*, the world leader in cellular technology. The phones are packed with features that put you in control and give you unrivalled power, whilst remaining discrete.

Control

- Customisable Quick Access Menu  - Place nine of your most frequently used features in your own personal menu so that they can be accessed with just two key presses. Icons make each feature easy to identify.
- VoiceNotes™ feature  - Allows you to record a number of personal voice messages or to record part of a phone call - useful when you haven't got pen and paper to hand for taking down directions or a message.
- Voice Control - Use voice commands to call up Phone Book entries and to select Quick Access options.

Discretion

- VibraCall™  - In locations where you don't want your phone to ring, or which are too noisy to hear your phone ring, your phone can vibrate to alert you of a call.
- Wearable Holster - Wear your phone in a stylish holster on your belt. It is small enough and light enough to keep with you almost anywhere.
- Stop Call Alert - Press the volume button when the phone is ringing or vibrating. This will stop the alert but not answer the call.

Power

- Superb battery performance  - Each phone is capable of several hours conversation or several days standby, but is still small and light.
 - Tri Band - versions of the phone include the powerful Tri Band feature which means that they can use 900, 1800 and 1900MHz bands for greater call success and allow wider roaming opportunities.
- ⚠ Before you use your phone, please see the 'Your Battery' section for important information on charging a new battery.**

Personality™

This cellular telephone incorporates **Personality™**. Unique to *Motorola*, **Personality™** removes the complexity of cellular communications by guiding you through the features and presenting you with simple choices every step of the way. **Personality™** also allows you to personalise the way you use your phone - for example, different ringer tones, a phone book and network selection preferences - all presented with clarity and simplicity. In this manual, each of the **Personality™** features is identified with an  symbol to indicate that it is customisable to meet your requirements.

Understanding this Manual

Many of your phone options are accessed by a simple menu system. A full description of the menus and how to move around them is covered in the next section **Menu Navigation**. When the manual describes the use of each menu item, it will be assumed that you are familiar with the menu system.

Key Presses

Key presses are represented in this manual using symbols so that you may locate and use the required sequence quickly. A sequence of key presses may be shown as follows:

M **OK** **C**

This means that you should press the **M** key followed by the **OK** key and then the **C** key, in sequence, not simultaneously.

Entering Information

When you are requested to enter information, such as the number of the phone you wish to call, this is represented in **bold** type. For example:

Phone No. - enter the required telephone number.

PIN Code - enter your Personal Identification Number.

Unlock Code - enter your unlock code.

Location - enter the Phone Book location number.

Prompts and Messages

Your phone responds to key presses by displaying either easy to understand prompts that guide you to the next action, or simple messages confirming that your action is complete. Prompts and messages are represented in this manual in LCD style, for example:

Enter PIN or Completed.

Other Symbols

You will find the following symbols used throughout this manual:

 A Note contains additional information which is relevant to the feature/item.

 A Caution contains important additional information which is relevant to the efficient and/or safe usage of your phone.

 This symbol indicates that the feature is a *Personality*TM feature that can be customised to meet your requirements.

 This symbol indicates a short key sequence for the feature.

Menu Navigation

A large number of your phone's options are accessed by using menus which use a common approach for selection, change and cancellation.

Please read this section carefully before attempting to access a menu option. When you understand the common approach to menu navigation and how the menus are shown on the page, you will be able to access and change options with ease.

Entering the Menus

Two different keys are used to access the menus:

(M) enters the Options menu whilst in standby mode; enters the In-call menu during a call.

(↑) enters the Quick Access menu.

Once entered, the menus use the **(↓↑)**, **(←*)**, **(#>)**, **(OK)** and **(C)** keys in a common manner to access, select and change individual options.

 You can use the **(↓↑)** or **(←*)**, **(#>)** keys to scroll round the menus in either direction.

Leaving the Menus

To leave any of the menus, you can either press and hold the **(C)** key or repeatedly press the **(C)** key. Both of these actions will return your phone to the standby mode.

 Alternatively, a quicker way to leave the menus is to press **(↑)(C)**.

Menus and Sub-menus

A menu is a simple list of options. Some of these options provide access to a further list of options called a sub-menu. When navigating through the menus you may find it is helpful to think in terms of menu levels - the 'parent' menu being on one level and its sub-menu being on a lower level.

Moving To and Selecting a Menu Option

To move from one option to another on the same level, use the scroll key **(↓↑)**. Pull **(↓↑)** down to move forwards and push **(↓↑)** up to move backwards. When you find the option you want, press the **(OK)** key to select it.

Depending on the option you select, one of three things will happen:

- either a brief message will be displayed confirming an action, for example **Completed**.
- or a prompt will be displayed requesting you to enter information, for example **Enter PIN** or **Enter Name**.
- or the first option of a sub-menu will be displayed. You can select this option using the **(OK)** key or browse through the other options using the scroll key.

To leave an option or sub-menu, press the **(C)** key. This will take you back to the parent menu item.

Menu Options with Security Codes

Some options are protected from misuse by requiring you to enter one of the security codes. To use these options, you must enter the requested code before proceeding.

Menu Navigation - A Working Example

The following steps will take you through how to switch the Extended Menu option on:

- 1 When the phone is in the standby mode, press the **(M)** key. This will access the Options menu and Access Internet will be displayed.[#]
- 2 Press the **(↓)** key repeatedly until the Phone Setup sub-menu item is shown in the display.
- 3 Press the **(OK)** key to select the sub-menu.
- 4 Press the **(↓)** key repeatedly until the Extended Menu sub-menu item is shown in the display.
- 5 Press the **(OK)** key to select this item. You can now select between On or Off, the current setting will be shown with a ✓ character. If the ✓ character is next to Off, press **(↑)** and then **(OK)** to switch on the Extended Menus. If the ✓ character is next to On, press **(C)** to leave the setting as it is.

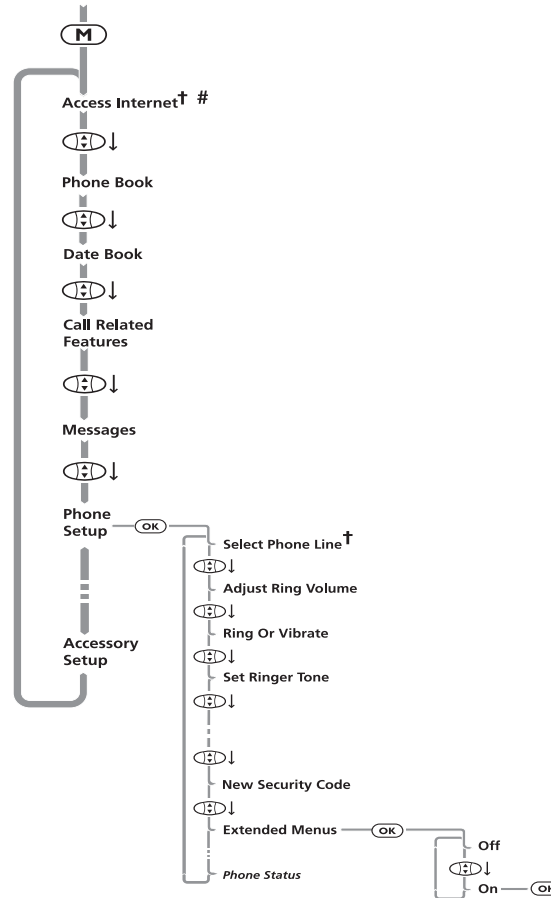

If your service provider has added their own menu, Access Internet will not be the first item in the Options menu.

† Availability depends on the type and settings of the SIM card and/or your subscription to these services where available.

OK Short, Extended and Personalised Menus

With *Personality*[™] you can personalise the menus by choosing which features you want readily available. The features that are less frequently used can be stored out of sight.

The menu diagrams in this manual show the condition of the menu settings when you first receive your phone. Some features are in the Short Menu and are shown in **bold** type. Other features are in the Extended Menu and appear in *italics*.

You can change which features appear in the Short and Extended Menus, and therefore personalise the menus, to suit your requirements.

If you want to move a feature from the Short Menu to the Extended Menu (or from the Extended Menu to the Short Menu), go to the feature and then hold down the **OK** key until a prompt appears offering the following choices:

- Add the current feature to the Short Menu/Extended Menu.
- Leave the current feature in the Short/Extended Menu.

Select the option you want by pressing the **OK** key.

Total Customer Satisfaction

At Motorola, Total Customer Satisfaction is a top priority. If you have a question, a suggestion or a concern about your Motorola Cellular Phone, Motorola wants to hear from you.

Please contact the Motorola Cellular Response Centre by fax on: +44 (0) 131 458 6732, or use one of the local phone numbers in the following countries:

Austria	0800 297246
Belgium	0800 72 370
Czech Republic	00420 2 21 85 21 01
Denmark	4348 8005
Egypt	02 3411800
Eire	01 402 6887
Finland	0800 117 036
France	0 803 303 302
Germany	0180 35050
Greece	00800 441 28150
Italy	02 696 333 16
Jordan	06 863750
Kuwait	484 2000 Ext 1177
Lebanon	01 744156
Luxembourg	0800 21 99
Netherlands	0800 022 27 43
Norway	22 55 10 04
Oman	790925
Poland	0801 620 620

Portugal	21 318 0051
Qatar	418999
Saudi Arabia	01 2303294
South Africa	0800 11 48 49
Spain	902 100 077
Sweden	08 445 1210
Switzerland	0800 553 109
Turkey	0212 425 9090
UK	0500 55 55 55
United Arab Emirates	04 32 11 66
Hong Kong	852 25063888
People's Republic of China	86 10 68466060
Singapore	65 4855 333
Taiwan	886 2 87731746
United States of America	1 800 331 6456
Canada	1 800 461 4575

For e-mail queries contact: mccr@ei.css.mot.com
For Internet queries contact: <http://www.motorola.com>

Warranty Information

Motorola warrants to you, the original purchaser, the cellular phone and accessories which you have purchased from an authorised Motorola dealer (the "Products"), to be in conformance with the applicable Motorola specifications current at the time of manufacture for a term of [1] year from date of purchase of the Product(s) (Warranty Term).

You must inform Motorola of the lack of conformity to the applicable specifications of any of the Products within a period of two (2) months from the date on which you detect a defect in material, workmanship or lack of conformity and in any event within a term not to exceed the Warranty Term, by submitting the Product for service to Motorola. Motorola shall not be bound by Product related statements not directly made by Motorola.

A list of the Motorola Call Centre numbers is enclosed with this Product.

During the Warranty term, Motorola will, at its discretion and without extra charge, as your exclusive remedy, repair or replace your Product which does not comply with this warranty; or failing this, to reimburse the price of the Product but reduced to take into account the use you have had of the Product since it was delivered. This warranty will expire at the end of the Warranty Term.

This is the complete and exclusive warranty for a Motorola cellular phone and accessories and in lieu of all other warranties, terms and conditions, whether express or implied.

Where you purchase the product other than as a consumer, Motorola disclaims all other warranties, terms and conditions express or implied, such as fitness for purpose and satisfactory quality.

In no event shall Motorola be liable for damages in excess of the purchase price nor for any incidental special or consequential damages[#] arising out of the use or inability to use the Product, to the full extent such may be disclaimed by law.

This Warranty does not affect any statutory rights that you may have if you are a consumer, such as a warranty of satisfactory quality and fit for the purpose for which products of the same type are normally used under normal use and service, nor any rights against the seller of the Products arising from your purchase and sales contract.

How to Get Warranty Service?

In most cases the authorised Motorola dealer which sold and/or installed your Motorola cellular phone and original accessories will honour a warranty claim and/or provide warranty service. Alternatively, for further information on how to get warranty service please contact either the customer service department of your cellular operator or Motorola's call centre at the telephone numbers below for your country.

In order to claim the warranty service you must return the cellular phone and/or accessories in question to Motorola please avoid leaving any supplementary items like SIM cards. The Product should also be accompanied by a label with your name, address, and telephone number; name of cellular Carrier and a description of the problem. In the case of vehicular installation, the vehicle in which the cellular phone is installed should be driven to the Authorised Repair Centre, as analysis of any problem may require inspection of the entire vehicular installation.

In order to be eligible to receive warranty service, you must

[#] including without limitation loss of use, loss of time, inconvenience, commercial loss, lost profits or savings.

present your receipt of purchase or a comparable substitute proof of purchase bearing the date of purchase. The phone should also clearly display the original compatible electronic serial number (IMEI) and mechanic serial number [MSN]. **Such information is contained with the Product.**

Conditions

This warranty will not apply if the type or serial numbers on the Product has been altered, deleted, removed, or made illegible. Motorola reserves the right to refuse free-of-charge warranty service if the requested documentation can not be presented or if the information is incomplete, illegible or incompatible with the factory records.

Repair, at Motorola's option, may include the replacement of parts or boards with functionally equivalent, reconditioned or new parts or boards. Replaced parts, accessories, batteries, or boards are warranted for the balance of the original warranty time period. The Warranty Term will not be extended. All original accessories, batteries, parts, and cellular phone equipment that have been replaced shall become the property of Motorola. Motorola does not warrant the installation, maintenance or service of the products, accessories, batteries or parts.

Motorola will not be responsible in any way for problems or damage caused by any ancillary equipment not furnished by Motorola which is attached to or used in connection with the Products, or for operation of Motorola equipment with any ancillary equipment and all such equipment is expressly excluded from this warranty.

When the Product is used in conjunction with ancillary or peripheral equipment not supplied by Motorola, Motorola does not warrant the operation of the Product/peripheral combination and Motorola will not honour any warranty claim where the

Product is used in such a combination and it is determined by Motorola that there is no fault with the Product. Motorola specifically disclaims any responsibility for any damage, whether or not to Motorola equipment, caused in any way by the use of cellular phone, accessories and peripherals (specific examples include, but are not limited to: batteries, chargers, adapters, and power supplies) when such accessories and peripherals are not manufactured and supplied by Motorola.

What Is Not Covered by the Warranty

This warranty is not valid if the defects are due to damage, misuse, tampering, neglect or lack of care and in case of alterations or repair carried out by unauthorised persons.

- 1 Defects or damage resulting from use of the Product in other than its normal and customary manner.
- 2 Defects or damage from misuse, accident or neglect.
- 3 Defects of damage from improper testing, operation, maintenance, installation, adjustment, or any alteration or modification of any kind.
- 4 Breakage or damage to antennas unless caused directly by defects in material or workmanship.
- 5 Products disassembled or repaired in such a manner as to adversely affect performance or prevent adequate inspection and testing to verify any warranty claim.
- 6 Defects or damage due to range, coverage, availability, grade of service, or operation of the cellular system by the cellular operator.
- 7 Defects or damage due to moist, liquid or spills of food.
- 8 Control unit coil cords in the Product that are stretched or have the modular tab broken.

9 All plastic surfaces and all other externally exposed parts that are scratched or damaged due to customer normal use.

10 Leather cases (which are covered under separate manufacturer's warranties).

11 Products rented on a temporary basis.

12 Periodic maintenance and repair or replacement of parts due to normal wear and tear;

 *The talk-time, stand-by time and total life cycle of a Motorola rechargeable battery for your cellular phone will depend on usage conditions and network configurations. As a consumable product, the specifications indicate that you should be able to obtain optimum performance for your Motorola Cellular Phone within the first six months from date of purchase and up-to (200) charges.*

The warranty for Motorola rechargeable batteries becomes void if (i) the batteries are charged other than by Motorola approved battery chargers specified for the charging of the battery, (ii) any of the seals on the battery are broken or show evidence of tampering, (iii) the battery is used in equipment or service other than the cellular telephone equipment for which it is specified.



Contents

Safety Information	
Important information for the efficient and safe operation of your phone.....	13
About Your Phone, Battery and SIM Card	
Introduces your phone, explains how to charge and maintain batteries, explains about your SIM Card.....	17
Making and Receiving Phone Calls	
Explains how to make single or conference calls, how to redial, how to transfer a call, and how to end a call.....	27
Using Voice Features	
Explains how to use the VoiceNotes™ and Voice Control features on your phone.....	37
Using the Options Menu	
Provides an explanation of the Options Menu and how to use it.....	45
Using the Quick Access Menu	
Provides an explanation of the Quick Access Menu and how to use it.....	107
Accessories	
Details the accessories available for use with your phone.....	113
What to do if...	
Helps you to solve any problems that may occur.....	115
Index	
A comprehensive Index	117

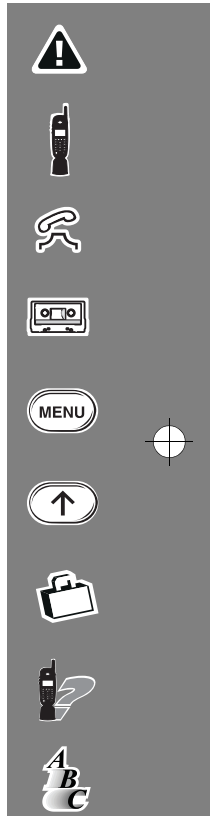

The Manufacturer reserves the right to make changes in technical and product specifications without prior notice.



Safety Information

IMPORTANT:
**Read this information before using
your wireless handheld phone.**

Exposure to Radio Frequency Signals

Your wireless handheld portable telephone is a low power radio transmitter and receiver. When it is ON, it receives and also sends out radio frequency (RF) signals.

International agencies have set standards and recommendations for the protection of public exposure to RF electromagnetic energy.

- International Commission on Non-Ionizing Radiation Protection (ICNIRP) 1996
- Verband Deutscher Elektrotechniker (VDE) DIN-0848
- United States Federal Communications Commission, Radio Frequency Exposure Guidelines (1996)
- National Radiological Protection Board of the United Kingdom, GS 11, 1988
- American National Standards Institute (ANSI) IEEE. C95. 1-1992
- National Council on Radiation Protection and Measurements (NCRP). Report 86
- Ministry of Health (Canada), Safety Code 6

These standards are based on extensive scientific review. For example, over 120 scientists, engineers, and physicians from universities, government health agencies, and industry reviewed the available body of research to develop the updated ANSI standard.

The design of your phone complies with these standards when used normally.

Antenna Care

Use only the supplied or an approved replacement antenna. Unauthorised antennas, modifications, or attachments could damage the phone and may violate local agency regulations.

Phone Operation

Normal Operation

Hold the phone as you would any other telephone, with the antenna pointed up and over your shoulder.

Tips on Efficient Operation

Observe the following guidelines to operate your phone most efficiently.

- Extend your antenna fully, if applicable.
- Do not touch the antenna unnecessarily when the phone is in use. Contact with the antenna affects call quality and may cause the phone to operate at a higher power level than otherwise needed.





Batteries

CAUTION: All batteries can cause property damage, injury, or burns if a conductive material, such as jewellery, keys or beaded chains, touches exposed terminals. The material may complete an electrical circuit and become quite hot. To protect against such unwanted current drain, exercise care in handling any charged battery, particularly when placing it inside your pocket, purse, or other container with metal objects. When the battery is detached from the phone, your batteries are packed with a protective battery cover; please use this cover for storing your batteries when not in use.

Driving

Check the laws and regulations on the use of wireless telephones in the areas where you drive. Always obey them. Observe the following guidelines when using your phone while driving.

- Give full attention to driving - driving safely is your first responsibility.
- Use hands-free phone operation, if available.
- Pull off the road and park before making or answering a call if driving conditions so require.

Electronic Devices

Most modern electronic equipment is shielded from RF signals. However, certain equipment may not be shielded against the RF signals from your wireless phone.

Pacemakers

The Health Industry Manufacturers Association recommends that a minimum separation of six inches (6") be maintained between a handheld wireless phone and a pacemaker to avoid potential interference with the pacemaker. These recommendations are consistent with the independent research by and recommendations of Wireless Technology Research.

Persons with pacemakers:

- should ALWAYS keep the phone more than six inches from their pacemaker when the phone is turned ON
- should not carry the phone in a breast pocket
- should use the ear opposite the pacemaker to minimise the potential for interference
- should turn the phone OFF immediately if you have any reason to suspect that interference is taking place

Hearing Aids

Some digital wireless phones may interfere with some hearing aids. In the event of such interference, you may want to consult your hearing aid manufacturer to discuss alternatives.

Other Medical Devices

If you use any other personal medical device, consult the manufacturer of your device to determine if it is adequately shielded from external RF energy. Your physician may be able to assist you in obtaining this information.

Turn your phone OFF in health care facilities when any regulations posted in these areas instruct you to do so. Hospitals or health care facilities may be using equipment that could be sensitive to external RF energy.

Vehicles

RF signals may affect improperly installed or inadequately shielded electronic systems in motor vehicles. Check with the manufacturer or its representative regarding your vehicle. You should also consult the manufacturer of any equipment that has been added to your vehicle.

Posted Facilities

Turn your phone OFF in any facility where posted notices so require.

Aircraft

Switch OFF your phone before boarding an aircraft.

Airline regulations prohibit using your phone while in the air. Check and comply with the policy of your airline regarding the use of your phone while the aircraft is on the ground.

Blasting Areas

To avoid interfering with blasting operations, turn your phone OFF when in a "blasting area" or in areas posted: "Turn off two-way radio." Obey all signs and instructions.

Potentially Explosive Atmospheres

Turn your phone OFF, do not remove your battery when you are in any area with a potentially explosive atmosphere, and obey all signs and instructions. Sparks from your battery in such areas could cause an explosion or fire resulting in bodily injury or even death.

Areas with a potentially explosive atmosphere are often but not always clearly marked. They include fuelling areas such as gasoline stations; below deck on boats; fuel or chemical transfer or storage facilities; areas where fuel odours are present (for example, if a gas/propane leak occurs in a car or home); areas where the air contains chemicals or particles, such as grain, dust, or metal powders; and any other area where you normally would be advised to turn off your vehicle engine.

For Vehicles Equipped with an Air Bag

An air bag inflates with great force. Do NOT place objects, including both installed or portable wireless equipment, in the area over the air bag or in the air bag deployment area. If in-vehicle wireless equipment is improperly installed and the air bag inflates, serious injury could result.



European Union Directives Conformance Statement



This product is in conformance with the requirements of the applicable EU Council Directives.

Declarations of Conformance with the requirements are located at:

Motorola Ltd.
Personal Communications Sector -
Europe, Middle East and Africa
Midpoint, Alençon Link
Basingstoke, Hampshire RG21 7PL
United Kingdom









APPROVED for connection to
telecommunications systems specified
in the instructions for use subject to
the conditions set out in them.



S/1357/4/V/503894

About Your Phone, Battery and SIM Card



Special Keys

-  Turns the phone on and off.
 -  Accept call, setting, option.
 -  Reject call, setting, option.
 -  Enter the Quick Access menu.
 -  Press to access the options or phone book menus.
 -  Press both simultaneously to lock the keypad on flipless models; also use to scroll left and right.
 -  Pull down to scroll forwards and push up to scroll backwards.
 -  Press to call Voicemail.
-  *The shape of the keys that appear in the manual may vary slightly from those on the phone.*

The Flip (if fitted)





Opening the flip answers the call (when the 'Key Answer Only' feature is set to Off, the default position). Closing the flip ends the call.

The Smart Button

The Smart button () is on the left-hand side of your phone, below the volume button. Press it to quickly access all your Phone Book entries, and then either scroll through the entries using the volume button or press one of the alphanumeric keys to search for a specific name - for example, press  to search for the name Pam, or press  four times to search for the name Sam.

 *If a Phone Book entry does not have a name, it will not be displayed.*

If you are using the optional headset, you can also use the Smart button to make, answer and end calls as follows:

- To answer a call, press  for 1.5 seconds.
- To end a call, press  for 1.5 seconds and then quickly press  again.
- To make a call, enter or recall a number and then press and hold  for 1.5 seconds.
- To voice dial a Phone Book entry, press . The prompt Say Name After Tone... appears. Wait for the tone to finish and then say the name associated with the number you want to call.

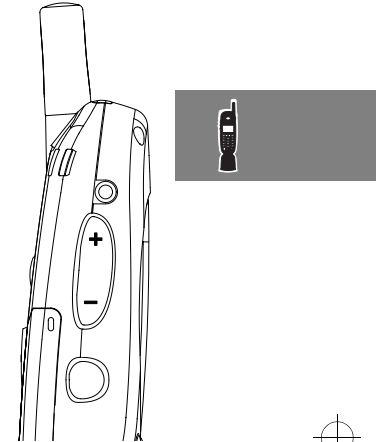



Volume Button

The Volume button is on the left-hand side of your phone, above the Smart button. The button is used for adjusting the keypad, earpiece and ringer volume. A volume meter will display the current volume setting. The meter will disappear after a short time, or if you press



OK or **C**.

- To adjust the keypad and earpiece volume, press the button with no other features selected.
- To adjust the ringer volume, first select the 'Adjust Ring Volume' option in the Phone Setup Menu and then use the button to set the required volume.

If you receive a call and you do not want to answer it immediately, you can press the volume button to stop the phone from ringing or vibrating. This will not answer the call.

Automatic Volume Control

If you have set the earpiece volume to maximum and the phone detects a high level of background noise, the earpiece volume automatically increases by an additional two steps.

When the level of background noise returns to normal, the earpiece volume automatically returns to the normal maximum.



The Start/Stop Record Button

The Start/Stop Record button () is on the top of your phone. Press it to start and stop recording VoiceNotes™. Refer to **Using VoiceNotes™**, for more information.

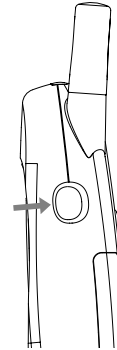

The Display

The display on your phone can show alphanumeric characters as well as useful information symbols. The various elements of the display are as follows:

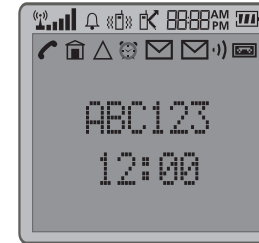

ABC123

Characters are used to display messages and telephone numbers.



Signal Strength. The more segments displayed in the bar graph, the better the signal strength.



Ringer On/Off. Displayed when the call ringer is selected. If you select the No Ring Or Vibrate or the Vibrate Only options this symbol will not be displayed.



Vibrate On/Off. VibraCall™ will be switched either on or off depending on the current setting.





Divert On/Off. Unconditional voice call diversion will be switched either on or off depending on the current setting.



Real Time Clock. In the idle display, the real time clock can display the time in either a 12-hour or 24-hour format.



Battery Charge Indicator. The more segments displayed, the greater the battery charge.



In Use. Displayed when a call is in progress.



Home Zone. Availability depends on your service provider.



Roam. Displayed when you are registered on a system other than your home system.



Alarm On/Off. Displayed when the date book reminder setting time is reached. It switches off at the event start time.



Short Message Service. Displayed when the phone has received a message. The symbol will flash when your message storage area is full.



Voicemail Waiting Indicator. Displayed when you have a voice message waiting. The availability of this feature depends on your service provider.



Answering Machine Indicator¹. Displayed when there is an unread voice message.



Icons are displayed when you are in the Quick Access menu.

1. This feature is not available in all countries.

In addition, when you are expected to press the **OK** key, a prompt will appear in the display, for example **Completed**.

Low Temperature Use

The liquid crystal display used in your phone will behave differently at extremely low temperatures. You may notice that the display responds slowly to key presses; this is to be expected and does not affect the phone operation in any way.

Animated Icons

A set of animated icons is provided in your phone. These icons represent current activity on your phone.



Animated Icon	Description
	Ringing
	Calling a number
	Ending the call
	SMS Message sent

Earpiece Connector

The earpiece connector is on the left-hand side of your phone, above the volume button. Use this connector for the headset accessories available from your *Motorola* stockist.





Communicating with External Devices

To communicate with an external device, such as a personal computer, your phone includes the following features:

- an infra-red lens located next to the antenna on the top of the phone.
- an RS-232 serial data port located at the bottom of the phone.

Setting up the Infra-Red Feature

 Press . Select the Quick Access feature or, after the tone, say the Voice Tag name.

Before you can transfer your data:

- Align the infra-red lens on your phone with the infra-red lens on the external device.
- Make sure that the infra-red feature is active in both the phone and the external device.

The phone and the external device can be up to 30 cm apart.

For operating details, see 'Activate IR Port' in the **Phone Setup Menu** section of this manual.

Setting up the RS-232 Serial Data Port

The RS-232 serial data port requires a *Motorola* 3-pin RS-232 serial data cable. This is available from your *Motorola* stockist.

To connect the cable to your external device, please refer to the manufacturer's documentation.

Looking After Your Phone

- Never leave your phone or battery in extreme temperatures (over 60°C), for example behind glass in very hot, direct sunlight.
- To clean your phone, use a moistened or antistatic cloth. Do **not** use a dry or electrostatically charged cloth.

The Status Indicator

The status indicator on the top of the phone provides you with the following information:

Incoming Call	Alternate Red/Green
In Service	Flashing Green
No Service	Flashing Red
Roaming	Flashing Yellow

Your Battery

Charging a New Battery

New batteries are supplied in a totally uncharged state.

To ensure maximum battery performance, a new battery (or battery that has not been used for several months) should be charged for at least 14 hours before use.

 A new battery will require several full charge/discharge cycles in order to achieve its optimum performance.

 A new battery, or a battery that has not been used for several months, may cause a premature fully charged indication. Ignore this indication and let the battery charge for several more hours, remove and re-insert the battery into the charger, and charge for an additional 14 hours.

Important Battery Information

 Always treat your batteries with care. See 'Batteries', at the beginning of this manual.

 Never leave your battery in extremely high temperatures (over 60°C), for example behind glass in very hot, direct sunlight.

 Only Motorola Original Accessory batteries should be charged in the phone or the optional desktop charger. This is to protect you and your phone from the risks of incorrect charging.

 Do not use lithium ion batteries at extremely low temperatures as the maximum standby/talk time will not be available when cold.

To ensure that you enjoy maximum battery life and use your battery to its fullest capacity:

- The battery should be at or near room temperature when charging.

Battery Performance and Maintenance

- Best battery performance will be achieved when you regularly charge and discharge batteries as instructed in this manual.
- Battery performance is greatly affected by network coverage.
- Set Battery Saving Mode to On (see *Phone Setup Menu*) and/or Frequency Of Search to Slow or Medium (see *Network Selection Menu*.)
- If left unused, a fully charged battery will discharge itself in approximately one month.
- When not in use, store your battery uncharged in a cool, dark and dry place.

Low Battery Warning

When the battery level is low and only a few minutes of talk time remain, a warning signal (two double beeps) will sound, the border of the battery symbol will begin to flash, and Low Battery will be displayed.

When the battery is completely discharged, your phone will turn off.



Removing Your Battery

! Switch off your phone before removing the battery.
Failure to do so may damage your phone memory.

- 1 Press the release catch on the battery compartment and lift off the cover.
- 2 Push the battery towards the top of the phone and lift the battery out from the bottom end.

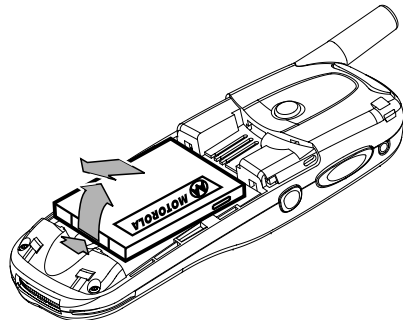

- 3 Press the battery towards the connections and push it downwards until it clicks into place. Replace the cover.

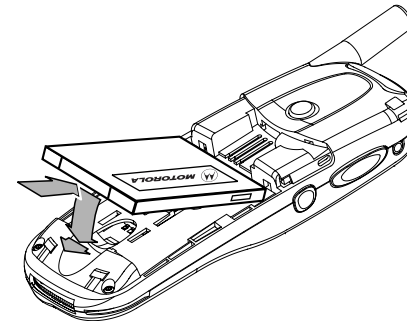

Fitting Your Battery

- 1 Remove the battery compartment cover.
- 2 Align the connections on the battery with the connections on the phone.

Charging Your Battery Using the Travel Charger

The travel charger can power the phone and charge a fitted battery.

! Ensure that the local mains voltage at your location matches that of your travel charger.

Fit a battery onto your phone.

To charge your battery:

- 1 Attach the correct adapter plug to the travel charger.

- 2 Connect the travel charger to the phone.

 *The connector is keyed and can only be inserted one way.*

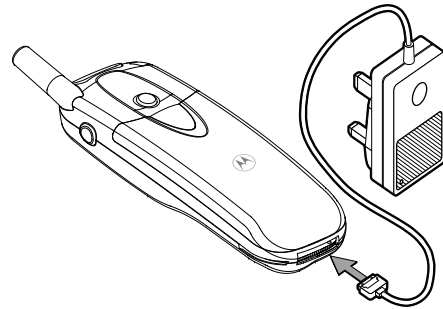

- 3 Insert the travel charger plug into a suitable mains power socket.

A beep-tone is heard and the battery icon flashes when charging begins.

The state of charging is monitored and displayed by your phone. See 'Battery Meter Indicators', later in this section for details.

 *Your phone can be either on or off during charging.*

 **Do not press  during charging.**

Desktop Charging Your Battery

 *The Desktop Charger is an optional accessory that allows you to charge both the battery fitted in your phone and a spare battery together (phone battery followed by spare battery).*

Batteries charge in about 2 to 3 hours, depending on the battery.

 *It is normal for batteries to become warm during charging.*

- 1 Connect the travel charger to the desktop charger socket. (The connector is keyed and can only be inserted one way.)
- 2 Plug the travel charger into a standard mains socket.
- 3 Insert your phone into the desktop charger as shown.

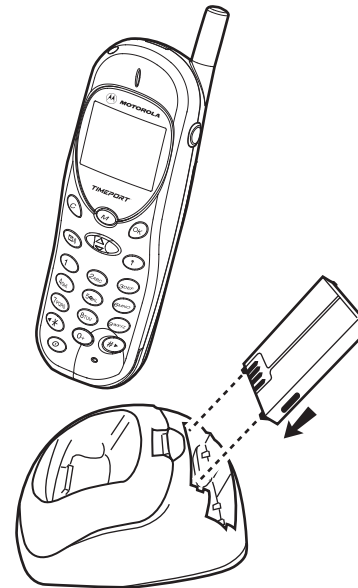

A spare battery can be charged on its own or at the same time as your phone. Insert the battery into the desktop charger as shown.

 *Charge times will increase if you make or receive phone calls while charging.*





Connecting Data Cable

Please refer to the desktop charger instruction literature.

It is recommended that you use only Motorola original batteries, chargers and other accessories.

Battery Indicators on the Phone Display



Your Motorola cellular phone includes the Motorola Expert Performance (E-PT+) charging system. This enables the charging circuits in both the phone and the optional (E-PT+) desktop charger to communicate directly with the battery. Based on this communication, the charger can implement the optimum charging cycle for best performance and determine the level of charge.

Your phone monitors and displays information about your battery. The following message will appear on the phone display, as the condition occurs:



Low Battery	The battery charge is low. The battery should be recharged.
Insert Battery	No battery fitted; external power connected
Invalid Battery	This message is accompanied by a single beep. Your phone is alerting you that you do not have charging capabilities with this battery even though the battery may be able to power the phone. The most likely reason why your charging system does not recognise the battery is that the battery you have purchased is not a Motorola original battery and therefore does not have the communications technology built into it. All Motorola original batteries include this communications technology.

Battery Indicators on the Desktop Charger

The following LED indicators flash/light on the desktop charger base, as the condition occurs:



Front pocket phone indicator:

Lights up yellow only when the phone is properly seated in the charger. Check the charging status on the phone display. If there is a battery in the back pocket and the phone display is off, the phone battery is fully charged.



Back pocket battery indicator:

Left side solid red indicates that the battery is charging; right side flashing yellow indicates that the battery is waiting to be charged; both sides solid green indicates that the charging is complete (battery > 90% charged); both sides flashing red indicates an invalid or faulty battery has been detected or that there are two batteries in the back pocket and the batteries will not be charged.



Data indicator:

Flashes green only when data is transferring to an attached PC with the appropriate optional data cable. Data transfer must be initiated through the PC.



Battery Meter Indicators

The battery meter displays different messages depending on the batteries attached, and whether or not there is an external power source. The battery meter is found in the Call Related Features part of the Options Menu.

Charging Battery	The battery is being charged.
Charging Complete	Charging is complete.
Invalid Battery	Battery may be defective, or may not be a Motorola original battery.

 *When the battery is completely discharged, you must charge the battery for one minute before you can make or accept a phone call.*

Your SIM Card

Your SIM (Subscriber Identity Module) card was supplied by your Cellular Service Provider when you bought your phone. You will not be able to make or receive calls if you do not have a SIM card inserted in your phone.

 *Some networks allow you to make emergency calls without a SIM card inserted.*

The SIM card is a 'Smart Card' that contains your phone number, service details and memory for storing Phone Book numbers and messages. You can therefore use your SIM card in someone else's GSM phone and you will be charged for the call.

Like a bank or credit card, you should keep your SIM card secure. Do not bend or scratch your card and avoid exposure to static electricity or water.

 **Switch off your phone before inserting or removing the SIM card. Failure to do so may damage the memory on your SIM card.**





SIM Card Insertion/Removal

- 1 Switch off your phone by pressing and holding the  key, remove the battery cover and the battery.
- 2 Press slightly at the edge of the lever marked "PRESS".
- 3 Slide the SIM card into the slot in direction as indicated on the SIM card holder.
- 4 The SIM card stays in the holder such that the notch is in the bottom right-hand corner
- 5 Replace the battery and battery cover.
- 6 To remove, press the lever inward and gently push the card up.

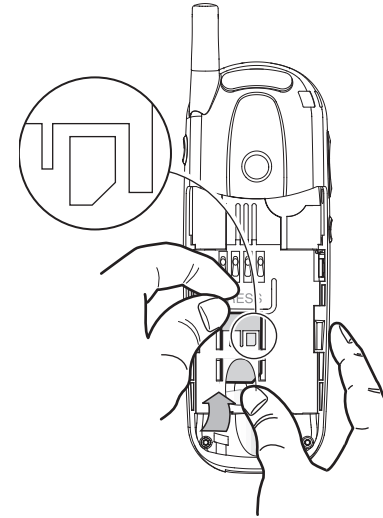
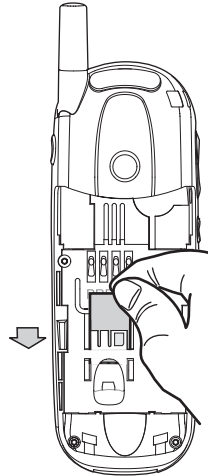

If the SIM card is inserted the wrong way round, or damaged, the Check Card message may be displayed. Remove the SIM card, check that it is the right way round and then re-insert it into the phone.

! *To avoid damage and malfunctioning, do not deliberately pull or pry open the strips on the SIM card holder.*

If either of the Bad Card See Supplier or Blocked See Supplier messages are displayed, then you will need to contact your Cellular Service Provider.

Making and Receiving Phone Calls

Switching the Phone On and Off

To switch the phone on or off, press and hold the  key. If VibraCall™ is selected, the phone will vibrate when it is switched on.

If you switch the phone on and there is no SIM card inserted, you will be asked to insert one. Once inserted, the phone will check that the SIM card is valid.

A number of messages will then be displayed:



- Enter PIN - a request to enter the SIM card PIN code (if required).
- Enter Phone Unlock Code - a request to enter the phone unlock code (if required).
- Searching... followed by a network name - as the phone searches and then finds a suitable network to connect to.

Once switched on and connected, the phone stays in idle mode.

Entering Your SIM Card PIN Code

To enter the PIN code, enter **PIN Code** .

As you type in each digit of the PIN code a * character will be displayed.

If you make a mistake, press and release the  key to remove the last digit. Holding the  key down will remove the entire entry.

When the PIN code is complete press the  key.

If the PIN code entered is incorrect, the warning message  will be displayed, followed by Enter PIN.



! If the PIN number is entered incorrectly three times in a row, your phone will automatically lock-up and the Blocked message will be displayed. See 'Unlocking Your Phone' for details on unlocking your phone.

The PIN code can be changed, see 'Change SIM PIN Code' in the **Phone Setup Menu** section for more details.







OK Entering Your Unlock Code

If your phone displays the message Enter Phone Unlock Code you must enter your unlocking code by entering **Unlock Code** .

The unlock code is a four digit number which is set at manufacture to **1234**. The code can be changed, see 'Change Unlock Code' in the **Phone Setup Menu** section for more details.

If you forget your unlock code, press the  key. This will display the 'Change Unlock Code' option. Enter  **Security Code**, enter a new unlock code, and press .

Locking the Keypad

Press the  and  keys simultaneously to prevent accidental usage of the phone. To remove the lock, press  and  simultaneously. All keys with the exception of the  key will be disabled. You can still answer an incoming call by pressing  when the keypad is locked.



Making a Phone Call

To make a phone call, your phone must be switched on and unlocked.

It will not be possible to make a phone call unless you are in an area where there is a GSM900, 1800 or 1900 service. When a service has been found, a series of rising bars, , will show the signal strength.



There are a number of different ways to make a phone call:

- Using the digit keys.
- Using automatic redial.
- Redialling the last number called.
- One-touch dialling a Phone Book entry*.
- Dialling a Phone Book entry*.
- Calling an embedded number in a message.
- Using the Smart button (Ⓢ) and Voice Dialling.

 *Your phone contains a 'phone book' that can be used to store names and telephone numbers. See 'What is the Phone Book?' for further details.

The simplest method of making a phone call is to enter the number using the digit keys then press **OK**.

 If you make a mistake, press and release the **C** key to remove the last digit. Holding the **C** key down will remove the entire number.

To indicate that you are making a phone call, your phone displays the outgoing call animation and the word **Call in**. If the call is not answered and you want to end the call, press **OK** or close the flip (models with flip only).

When the phone call is answered, the display will change to **End Call?**.

To end your call, press **OK** or close the flip, if applicable.

Automatic Redial

If your call attempt does not succeed, the message **Redial?** will be displayed for five seconds. Pressing **OK** at this point will automatically redial the phone number.

When the call is answered, you will hear a short ring tone.

The maximum number of redial attempts is set by your Cellular Service Provider. If the phone call cannot be connected within this maximum, the message **Redial Failed** will be shown.

Redialling the Last Number Called

 When in standby mode, press **OK OK**.

Alternatively, you can retrieve the last number dialled using the 'Last Ten Calls' feature in the Phone Book menu.

OK One-Touch Dialling Phone Book Numbers

To quickly retrieve and dial a number stored in the first nine locations of your Phone Book¹, press and hold the appropriate digit key. For example, pressing and holding (2^{ARC}) will dial the phone number stored in location 2 of your Phone Book.

 You do not need to press (OK) to call the number.

OK Dialling Phone Book Numbers

Alternatively, enter the phone book (Location) number followed by (#) (OK).

OK Dialling Phone Book Numbers with Smart Button

The following Smart button (Ⓢ) options are available:

- Press (Ⓢ) and say the Voice Tag name after the tone. See 'Using Voice Activation with Phone Book Entries', for more information.
- Press (Ⓢ) and use the volume button to scroll to the stored number, or press the appropriate digit key to skip to a particular letter. To make the call, either hold down (Ⓢ) for 1.5 seconds or press (OK).

Calling an Embedded Number in a Message

Details on how to call a number embedded in a message are given in the **Messages Menu** section.

1. The Phone Book entries that you are able to access will depend on the One-Touch Dial Setting option in the Phone Book menu.

International Phone Calls

To make an international phone call press and hold the (0+) key. After a couple of seconds the international dialling prefix + will appear in the display, this allows you to call from any country without knowing the local international access code.

Now enter the country code, followed by the phone number. The country code follows the conventional format, 49 for Germany, 44 for the UK, 46 for Sweden, etc.

Just like a conventional international call, remove the leading '0' of the area code when you dial.

Inserting Pauses Into Phone Numbers

To obtain a three second 'pause' character in a phone number, press and hold the (*) key for a couple of seconds, the pause symbol ▯ will appear.

The pause character produces a three second delay whenever it is used. However, the first pause character in a phone number is a special case, it will not begin its delay until the call is answered.

Pause - A Working Example.

If, for example, you have a tone-based voicemail system on 555-6911, with a mailbox number 1066 and password 2001. Then you may dial the following number:

5556911=1066=2001(OK).

The first part of the number would be used to call the voicemail system.

When the call is answered the first pause will produce a delay of three seconds before the tones for 1066 are sent to select the mailbox.

There will be a second pause of three seconds before the tones for 2001 are sent as the password.



GSM Emergency Calls

The world-wide GSM standard provides a single, uniform number, 112, to dial in cases of emergency.

Provided that your phone has found a network, you will be able to make an emergency call. The call can be made regardless of any security codes and, depending on the network, with or without a SIM card inserted.



The emergency call will be directed to a central emergency operator.

To dial the GSM emergency number, press **1 1 2** **OK**.

While the emergency call is being made and connected, the display will show *Emergency Calls*.

Receiving a Phone Call

To receive a phone call:

- Your phone must be switched on and unlocked.
- You must be in an area where there is GSM900, 1800 or 1900 service.
- Your Call Diversion and Call Barring settings should not be set to divert or bar incoming calls.

When your phone receives a call, it will ring or vibrate and your phone displays the incoming call animation and the word *Answer?*. If you have Caller Line Identification, the caller's number or name also appears.

To answer the call, press **OK** or open the flip (only on models with a flip when the 'Key Answer Only' feature is set to Off).

When the identification is displayed, you can decide whether or not to answer the call by pressing **OK**, a numeric key (**1** to **9** **WXYZ**), ***X** or **#**. You can also answer using the keys if the phone rings whilst the phone is already open.

If you do not wish to answer a call you can either:

Press and release the **C** key. If you have enabled the 'Detailed Diverting - If Busy' or 'Divert when unavailable' options in the Options Menu, the caller will be diverted to the forwarding number, otherwise the caller will hear the busy tone.

or

Press and hold the **C** key. This will reject the incoming call. No call divert option will be offered.

If your phone rings and you do not answer it, the message *Unanswered Call* will be displayed to show you that a call attempt was received.

Ending a Phone Call

To end a phone call, press **OK**, **C** or close the flip (models with flip only). Your phone displays the ending call animation.

Unanswered Call Notification

When you have received an unanswered call, your phone displays the message *Unanswered Call - OK?*

Press **OK** to display the first call missed. The details include the name and number of the caller. If the name of the caller does not appear in the phone book, *(No Name)* appears on the display.

Press **↓** to display the time and date for the unanswered call. |

The option *Call?* appears in the bottom right-hand corner of the screen. Press **OK** to call the number, or press **C** repeatedly to return to the idle screen.



In-Call Menu

The "In-Call" menu provides access to additional functionality during a call.

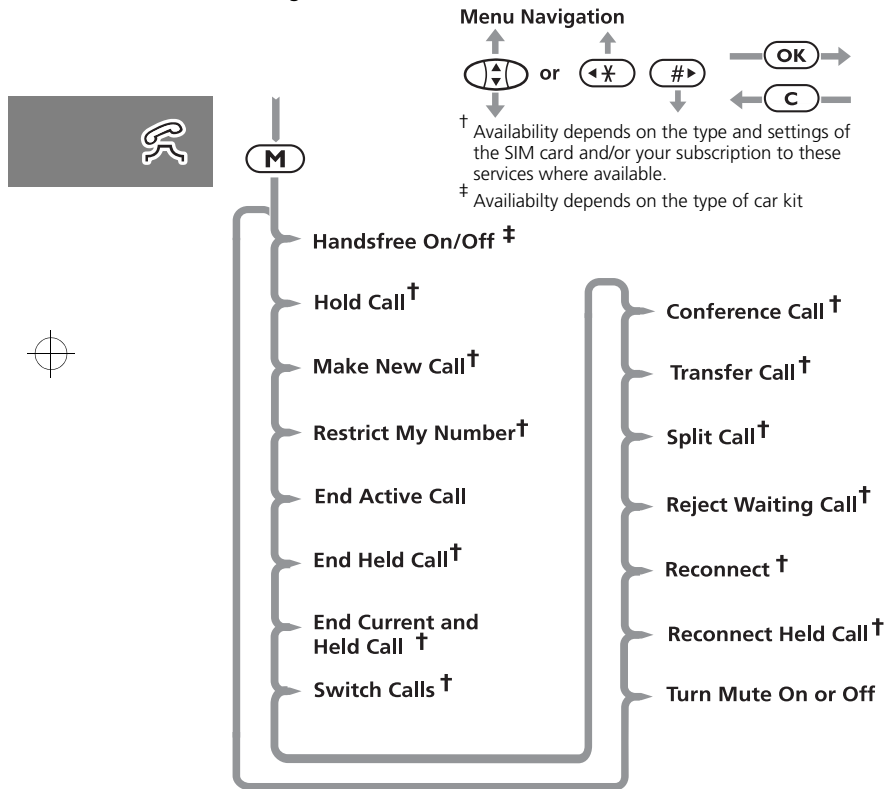

Entering the In-Call Menu

The "In-Call" menu is accessed by pressing the **(M)** key during a call.

Leaving the In-Call Menu

To leave the "In-Call" menu press the **(C)** key.

In-Call Menu Options

The options listed in the "In-Call" menu will dynamically change depending on the current call state. The following list contains all of the possible options in the "In-Call" menu.

Only some of the options will appear at any given time. The order of the options may vary.

Handsfree On/Off

This option is used to switch between Handsfree and normal operation if the phone is installed in a car kit that does not have an automatic presence detector.

Hold Call

This option will put the active call on hold.

Make a New Call

This option allows you to make another call.

Restrict My Number

This option allows you to make a call without the remote user getting advanced warning of the number.

End Active Call

This option terminates the active call, and makes the call that was previously on hold, the active call.

End Held Call

This option will terminate a held call.

End Current And Held Call

This option will terminate all connected calls.

Switch Calls

This option allows you to switch between the active call and the call that is on hold.

Conference Call

This option connects you with up to five other telephones on one call (see *Making a Conference Call*).

Transfer Call

This option transfers a call to another telephone (see *Transfer Call* later in this section).

Split Call

This option allows you to separate an individual from the main Conference Call.

Reject Waiting Call

This option will reject a waiting call.

Reconnect

This option will make the call on hold the active call.

Reconnect Held Call

This option is similar to *Reconnect?* but will appear if you have a call on hold, and a call waiting. *Reconnect Held Call* will make the call on hold the active call.

Turn Mute On or Off

Temporarily turns the microphone off during a phone call. Reselect this option to resume your conversation.

OK Call Holding and Call Waiting

Your phone supports the GSM options of Call Holding and Call Waiting. Using these options you can place a current phone call on hold and accept an incoming call or start a second call (See 'Call Waiting' in the **Call Related Features Menu** section for details of how to control this feature).

Call Holding and Call Waiting Scenarios

The display will automatically change according to the status of your current call (or calls) and will propose the option that you are most likely to want. Press **OK** to accept this option or press **M** and then **↑** to scroll through the "In-Call" menu for the alternative options. By following this procedure you will find that even the triple combination of an active call, a held call, and a call waiting is easy to manage.

The following points summarise the more common situations:

- To put an active call on hold, press **M**, the display will show *Hold Call - Select?* - press **OK** to put the call on hold. To reconnect the call, press **OK**.
- To put an active call on hold and make another call, first put the active call on hold, then press **M** and select the *Make New Call* option¹.
- To switch between an active call and a held call press **OK** at the *2 Calls - Switch?* prompt.

1. A quicker method of making another call is to enter the number to be called directly and press **OK**. Your phone will place the current call on hold and attempt to call the number entered.

- To accept a waiting call during an active call, press **(OK)** at the Call Waiting - Answer? prompt. The active call will be placed on hold. If you prefer to end the active call before accepting the waiting call, press **(M)** and select the End Active Call option.
- To reject a waiting call, press **(M)** and select the Reject Call Waiting option (or simply press the **(C)** key).

 *If you have an active call, a call on hold and a call waiting, you cannot accept the waiting call until you end either the active call or the held call, or join the active and held calls.*



Call Holding and Call Waiting Messages

During Call Holding and/or Call Waiting operations, your phone may display one or more of the following messages:

Trying

A request to hold the active call, swap the active with a held call, or add a member to a Conference Call, has been made.

or

A request to reconnect the held call has been made.

Hold Failed

The request to hold a call has been unsuccessful.

Cannot Hold Second Call

A call is already on hold, you cannot place two calls on hold at the same time.

Connection Failed

The held call could not be made active again.

Busy Try Later

Your phone is still working on a previous command. Wait a short time before repeating the command.

Anonymous

The person who is calling you has blocked their number from appearing on your phone.

Unavailable

The network is unable to provide the caller's number.

Conference Unsuccessful

The request for Conference Call has been unsuccessful.

Transferring Call

A request to transfer a call has been made.

Transfer Unsuccessful

The request to transfer a call has been unsuccessful.

Making a Conference Call

This option joins the active call with a held call. With Conference Call, you can have a conference with up to five other telephones. At any time during your call, you can add, disconnect or separate individuals from the Conference Call using other "In-Call" menu options.

 You must subscribe to both Conference Call and Call Waiting Supplementary Services to be able to use this feature.

Initiating a Conference Call

To initiate a Conference Call, place the active call on hold, and dial another phone number. You will then have one active call and one call on hold.

Press the **(M)** key to enter the "In-Call" menu and select Conference Call. The currently active call and the call on hold will then join into one Conference Call.

Managing a Conference Call

While in a Conference Call, you will have the option to add new calls to the Conference Call or separate one of the members from the Conference Call.

Adding a New Call

There are a number of different ways to add new calls to the Conference Call:

- Using the digit keys.
- Using the Make New Call option from the "In-Call" menu.
- Recalling a Phone Book Entry using Quick Access.
- Answer Call Waiting.

No matter which method is chosen to add a new call, the original Conference Call will be first placed on hold while the new call is being connected. You must then enter the "In-Call" menu and select Conference Call to join the New Call with the original Conference Call in progress.

Separate One of the Members in the Conference

During a Conference Call, you will also have the option to separate a selected member from the main Conference Call.

 In order to separate a member from the main Conference Call, there must not be any calls on hold.

Press **(M)** during a Conference Call and select Split Call. You will then be presented with the phone number or name of all members of the Conference Call. Use the scroll keys to find the selected member of the Conference Call. Once the desired member is selected, press the **(OK)** key and select Split Call.

At this point, the selected call will be separated from the main Conference Call and private conversation between you and the selected member is possible.

To re-join all the parties again, select Conference Call from the "In-Call" menu.



Transfer Call

Transfer Call transfers a call to another telephone. There are two ways to transfer a call; *before* or *after* the third party is connected.

 You must subscribe to both Conference Call and Call Waiting Supplementary Services to be able to use this feature.



Initiating Transfer Call Before the Third Party is Connected

To transfer a call to another telephone, press the **(M)** key and select Transfer Call from the "In-Call" menu. Enter the number where the call will be transferred and press **(OK)**.

Your phone will then attempt to transfer the call. The display will show Transferring Call followed by Call Transferred. When the call has been successfully transferred, you will be disconnected automatically.

Initiating Transfer Call After the Third Party is Connected

If you already have an active call and a call on hold, press the **(M)** key and select Transfer Call from the "In-Call" menu. Your phone will then attempt to transfer the active call to the call on hold. The display will show Transferring Call followed by Call Transferred. Once the call has been successfully transferred, you will be disconnected automatically.

Using Voice Features

Using VoiceNotes™

The VoiceNotes™ feature allows you to record up to 2.5 minutes of personal voice messages or to record part of a phone call. This is useful when you don't have a pen and paper to hand for taking directions or a message. Recording is available during the following call scenarios:

- Phone idle (no calls).
- Single active call (includes conference calls).
- Active call plus waiting call.

Recording a VoiceNote™

To record a VoiceNote™, press the Start/Stop Record button (Ⓞ). You will hear a short tone to indicate that recording has started and the display will show the message *Recording* and the remaining recording time available.

If you are recording during a call, the person you are speaking to will hear a tone every 10 seconds to warn them that you are recording the call.

 *During the recording of an active call, both parties can be recorded at the same time.*

To stop recording a call, press the Start/Stop Record button (Ⓞ) or **OK**; on models with a flip you can also close the flip, although this will end the call. The display shows the message *VoiceNote XX Stored* where *XX* is the number of the storage location. VoiceNotes™ are stored in sequential locations.

Recording stops immediately with no further notification if:

- you choose to accept an incoming call while you are recording (the Call Waiting alert is played)
- you choose to initiate a call during recording a VoiceNote™.

VoiceNote™ Storage Capacity

The *Show Time Available* option in the Messages, VoiceNotes™ menu displays the amount of recording time available, see *Messages Menu*.

During recording, ten seconds before the recording capacity is reached you will hear a warning tone. If you do not stop recording within the time limit, recording will automatically stop and a single, one second tone will be heard, accompanied by the *Storage Full* message.

Playing VoiceNotes™

To play your VoiceNotes™, select the *Play VoiceNotes* option in the Messages, VoiceNotes™ menu or the Quick Access menu item (Ⓞ).

The first VoiceNote™ will begin to play after two seconds. The display will show *VoiceNotes, Playing...*

To move to the next VoiceNote™, pull (⏮) down once (twice if the current note is still playing).



Similarly, to move to the previous VoiceNote™, push (⏭) up once (twice if the current note is still playing). Press (⏹) to stop playing of the current VoiceNote™.



 If you selected Play VoiceNotes from the Quick Access Menu, the phone will simply return to its idle state.

Push  up twice rapidly to skip back to the previous message.

Pull  down to play the next VoiceNote™.

To play a VoiceNote™ stored at a specific location, press the appropriate digit key  to .

 It is not possible to playback VoiceNotes™ during a call.

Erase VoiceNote™



This option allows you to delete your VoiceNotes™ one by one.

Erase All VoiceNotes™

To erase your VoiceNotes™, select the Erase All VoiceNotes option in the Messages, VoiceNotes™ menu. You will be requested to confirm the deletion with the message Erase All VoiceNotes - Select?. Press  to confirm the deletion.

The confirmation message VoiceNotes Erased is displayed.

Set Alarm (Alarmed VoiceNotes™)

This option allows you to attach an alarm to a maximum of 5 recorded VoiceNotes™. You can set the frequency of the alarm and the time at which it will expire. The alarmed VoiceNotes™ can be set to expire on a specific day and time (One-Time), daily, weekly, every Monday to Friday or every Monday to Saturday.

 If an alarm has been set to expire at the same time as an alarmed VoiceNote™, the alarmed VoiceNote™ will be adjusted to expire one minute later than the set time.

Using Voice Activation

With Voice Activation, you can call up a phone number or activate a Quick Access feature with a single spoken command. The single spoken command is called a Voice Tag.

You can assign Voice Tags to call any of the Phone Book numbers in your phone memory, and you can also assign Voice Tags to activate any of the Quick Access features.

 You cannot assign Voice Tags to call any of the numbers in your SIM card memory.

When you are recording a Voice Tag, you cannot make or receive any calls.

For best results, when you record a Voice Tag, make sure there is no wind or background noise and speak in a clear, natural voice. Your phone allows you about two seconds for each Voice Tag.

Voice Activation for Phone Book Entries

You can add a new Voice Tag when you set up a new Phone Book entry or when you amend an existing Phone Book entry. Alternatively, you can overwrite an existing Voice Tag or delete it completely.

 You cannot record a Voice Tag if you have set Prevent Access To Phone Memory.

Add Voice Tag

This option is available from the Phone Book menu and allows you to add a Voice Tag to a new Phone Book entry.



When you select Add To Phone Memory, your phone prompts you to enter a number, name and location and then stores the entry. For more details, see **The Phone Book Menu**.

After the prompt Stored XXX, your phone then prompts you for a Voice Tag as follows:

1  Add Voice Tag?

Press **OK** to continue.

If there are already 25 Phone Book Voice Tags in your phone, Voice Tag Storage Full appears and your phone returns you to the Add To Phone Memory menu option. You must delete a Voice Tag before you can add another.

If there are Voice Tags available, your phone prompts you to:

2  Press OK When Ready

Press **OK** to continue.

3 Say Name After Tone...

Wait for the tone to finish and then say the name. For best results, use in an area with minimal wind or background noise.

4  Press OK When Ready

Press **OK** to continue.





5 Say Name After Tone...

Wait for the tone to finish and then say the name as you did in step 3 above. For best results, use in an area with minimal wind or background noise.

6 If the recording is successful, Please Wait appears after two seconds followed by Voice Tag Stored.

When a Voice Tag recording is successful, your phone returns you to the Add To Phone Memory menu option.



If the recording is not successful, for example, the name you used is too similar to another Voice Tag name, the phone displays the reason for not accepting the name and returns you to the

Press OK When Ready prompt.

Add or Edit Voice Tag and Delete Voice Tag

These options are available from the Phone Book menu or the Quick Access Menu. First, select either Find Entry By Name or Find Entry By Location.

After you enter the name or location details, you can select the appropriate Voice Tag menu option.

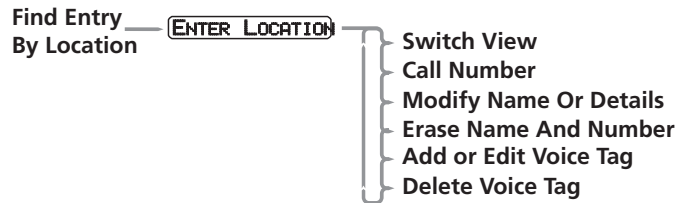

Add or Edit Voice Tag

This option does not appear if the phone number is not in phone memory.

Select this option to add a Voice Tag to the Phone Book entry or to overwrite an existing Voice Tag. If an entry already has a Voice Tag, the symbol)) appears after the location number.

When you select this option, the phone prompts you with Press OK When Ready.

To complete the Voice Tag recording, follow the same process as for 'Add Voice Tag'.

Delete Voice Tag

This option does not appear if the phone number is not in phone memory or if there is no Voice Tag to delete.

Select this option to delete the Voice Tag from the Phone Book entry.

When you press **OK**, the phone deletes the Voice Tag and returns the prompt Voice Tag Deleted.

Using Voice Activation with Phone Book Entries

You can use either the Smart button (Ⓢ) or you can use the Phone Book menu followed by Ⓢ.



Voice Activation using the Smart button (Ⓢ)

Press Ⓢ.

If there is a Phone Book entry with a Voice Tag, the following prompt appears:

1 Say Name After Tone...

Wait for the tone to finish and then say the name. For best results, use in an area with minimal wind or background noise.

If you press a key, you return to the Phone Book.

If the phone does not find a matching Voice Tag, No Match Found appears and you return to the Phone Book.

2 If the name you say matches a Voice Tag, the phone repeats the name and displays the Phone Book entry.

3 Do one of the following:

- Wait for two seconds and the phone makes the call.
- Press **OK** to make the call or **C** to cancel the call.
- Press **⏮** to display the next entry in the Phone Book.

When you scroll to a Phone Book entry that has a Voice Tag, your phone replays the Voice Tag through the speaker.

Voice Activation using the Phone Book Menu

Select Voice Dialling from the Phone Book menu.

When you press **OK**, the phone displays the message Press Smart Button When Ready.

To complete the voice activation, follow the same process as for 'Voice Activation using the Smart button (Ⓢ)'.

Voice Activation for Quick Access Features

You can use Voice Tags to activate any of the Quick Access features on your phone. You are not restricted to the nine Quick Access keys.

Quick Access Setup

Phone Setup

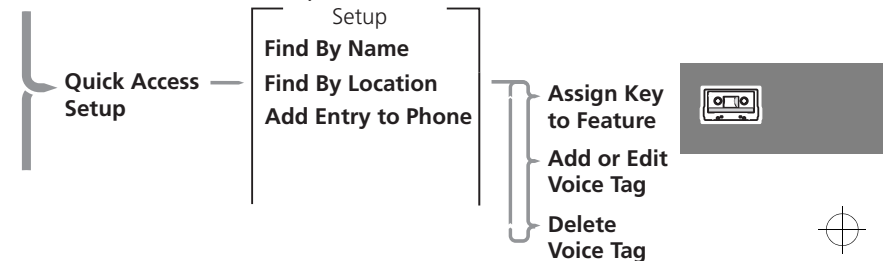

This option is available from the Phone Setup menu and allows you to do the following:

- Customise your Quick Access menu.
- Set up and change the Voice Tag allocation for the Quick Access features.

When you select Quick Access Setup, your phone displays a list of the Quick Access features. If a feature already has a Voice Tag, the symbol appears with the feature name.

Use **⏮** to highlight the feature you require and then press **OK**. You can then assign a key or change the Voice Tag setup.

Assign Key to Feature

Select this option to assign a key to the Quick Access feature. Your phone displays the prompt Enter 1-9:

Press **1** to **9** to assign a key and then press **OK**.

If you assign a valid key, your phone displays **Completed** and then returns you to the Quick Access feature list.

As an alternative, you can also assign a key using the Quick Access key (**↑**). See **Using the Quick Access Menu**.

**Add or Edit Voice Tag**

Select this option to add a Voice Tag to the Quick Access feature or to overwrite an existing Voice Tag.

If you attempt to add another Voice Tag when there are already 9 Quick Access Voice Tags in your phone, **Voice Tag Storage Full** appears and your phone returns you to the Quick Access feature list. You must delete a Voice Tag before you can add another.

If there are Voice Tags available, your phone prompts you to:

- 1 **Press OK When Ready**
Press **OK** to continue.
- 2 **Say Name After Tone...**
Wait for the tone to finish and then say the name. For best results, use in an area with minimal wind or background noise.
- 3 **Press OK When Ready**
Press **OK** to continue.

4 Say Name After Tone...

Wait for the tone to finish and then say the name as you did in step 2 above. For best results, use in an area with minimal wind or background noise.

5 If the recording is successful, Please Wait appears after two seconds followed by Voice Tag Stored.

When a Voice Tag recording is successful, your phone returns you to the Quick Access feature list.

If the recording is not successful, for example, the name you used is similar to another Voice Tag name, the phone displays the reason for not accepting the name and returns you to the **Press OK When Ready** prompt.

Delete Voice Tag

This option does not appear if there is no Voice Tag to delete.

Select this option to delete the Voice Tag from the Quick Access feature.

When you press **OK**, the phone deletes the Voice Tag and returns the prompt **Voice Tag Deleted**.

Using Voice Activation with Quick Access Features

To activate a Quick Access feature using Voice Activation:

- 1 Press **(↑)**.

If there is a Quick Access feature with a Voice Tag, the following prompt appears:

- 2 Say Name After Tone...

Wait for the tone to finish and then say the name. For best results, use in an area with minimal wind or background noise.

-  *At this point, you can press **(C)** to return to the idle screen; press a numeric key or **(OK)** to activate the appropriate Quick Access feature; push up or pull down **(↑/↓)** to display the Quick Access menu list.*

If the phone does not find a matching Voice Tag, No Match Found appears and you return to the Quick Access menu.

- 3 If the name you say matches a Voice Tag, the phone repeats the name and displays the entry for the Quick Access feature.
- 4 Do one of the following:
 - Wait for two seconds and the phone activates the feature.
 - Press **(OK)** to activate the feature or **(C)** to return to the idle screen.
 - Pull **(↑/↓)** down to display the next entry in the Quick Access menu.

When you scroll to a Quick Access feature that has a Voice Tag, your phone replays the Voice Tag through the speaker.





Using the Options Menu

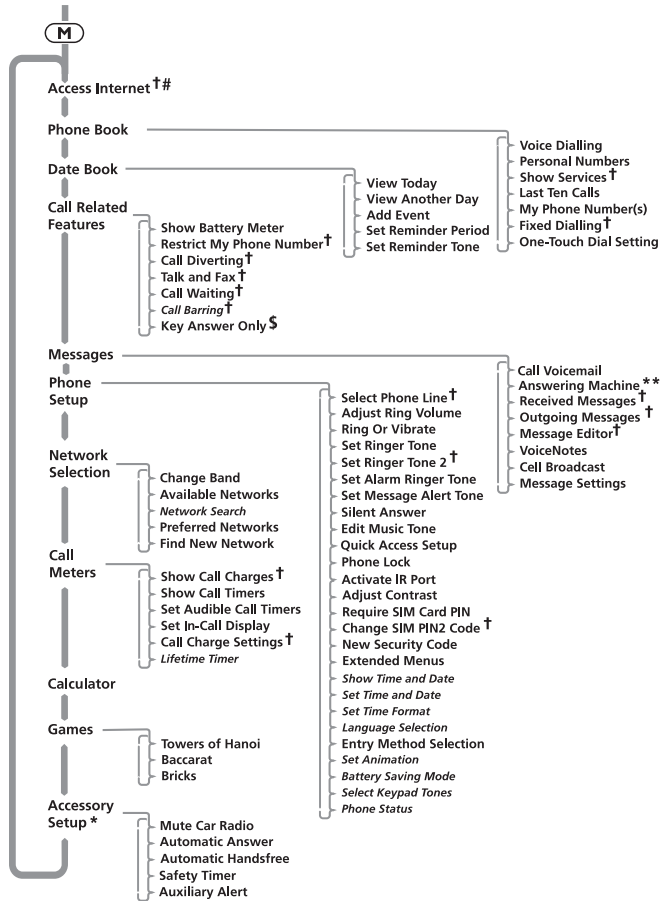

Menu Navigation

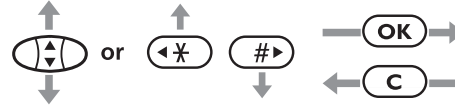

Items shown in *Italics* are available only when **Extended Menus** are switched on.

If your service provider has added their own menu, Access Internet will not be the first item in the Options menu.

† Availability depends on the type and settings of the SIM card and/or your subscription to these services where available.

* The **Accessory Setup** option is available only when a car kit or headset accessory are fitted.

\$ Only on phones with a flip.

** This feature is not available in all countries





Access Internet

Access Internet is a network and subscription-dependent feature. Contact your service provider for details about the mobile internet services based on the WAP (Wireless Application Protocol) technology that they provide.



Your phone has mobile internet access. This allows you to use the mobile internet services available from your service provider, for example, financial, sport, travel and entertainment information services.

This section explains:

- some of the common display features
- how to set up your phone for mobile internet access
- how to start a mobile internet session
- how to use and end the mobile internet session.

Common Display Features

Your service provider determines the layout and information that appears on the display. This example display illustrates a typical mobile internet screen and the soft keys you use to select and navigate through options.

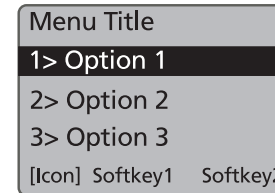

Using the Browser Menu

You can only access the Browser Menu during a mobile internet session. To display the Browser Menu:

- 1 Press either **M** or **↑**. When your phone prompts you with Access Internet, press **OK**.
- 2 Press and hold **M** until the Browser Menu appears.

You will then be presented with the following list of options:

- | | |
|-----------------------------|---|
| 1. Help | Provides help, if available, for the previously highlighted option. |
| 2. My Motorola ¹ | Takes you to the MyMotorola.com web site. |
| 3. Home | Returns you to the home page provided by your service provider. |
| 4. Mark Site | Allows you to add a site to your Bookmarks folder. |



- 5. Phone.com Takes you to the Phone.com web site.
- 6. Advanced Allows you access to advanced set up options.
- 7. Setup Contains the options to set up your mobile internet access.

1. Availability of this feature depends on your service provider

To select a menu option:

- 1 Scroll up or down using the key to highlight the appropriate menu option
- 2 Press to select it.

Using the Soft Keys

To select a soft key from the display during a mobile internet session, press or . The soft keys change so that they are appropriate for the current display, for example, Quit, Ok, Back or View. In the example display, selects the softkey1 and selects the softkey2.

Mobile Internet Icons and Messages

Icon or Message	Description
Sending))))	Sending data to the internet.
Receiving (((((Receiving data from the internet.
Connecting	Connecting to the internet.
Working	Performing an internet activity.
	Non secure internet connection.

The internet service you receive determines the icons and messages that appear on the display.

Setting Up for Mobile Internet Access

To set up your mobile internet access:

Your SIM card must be data enabled by your service provider.

- 1 At the Access Internet prompt, press .
- 2 Press and hold the key until the Browser Menu appears
- 3 Scroll up or down using the key to highlight option
- 4 Press to select it.

You will then be presented with the following options:

1. Primary Data
2. Secondary Data
3. Data Info

There are six options under this menu item:

- Phone #: This is the number that your phone will call to access the internet. Your Internet Service Provider(ISP) or operator issues this number
- Username: This is your user name. Your ISP or operator provides this name.
- Password: This is your password. Your ISP or operator provides this password.
- Baud Rate: This is set to 9600.
- Idle Time Out: This is set to 600.
- Line Type: This is set to ISDN.





- 1 Press **OK** to select Primary Data and **OK** again to edit the IP Address. Press **C** to clear the field and enter the IP address provided by your ISP. The IP address is in the format 123.123.123.123. After entering the address, press **OK**.
- 2 Using the **↓** key, scroll down to Port #: and press **OK**. Enter the number provided by your ISP, then press **OK**.
- 3 Then press **M** and scroll down to Data Info. These are the ISP details. Press **OK**.
- 4 Press **OK** to edit the Phone #: and enter the phone number supplied by your ISP. To get the +, press **M** 3 times until SYML appears, then press "1", then press **OK**.
- 5 Then scroll down to User: and enter the user name provided by your ISP. Press **OK**.
- 6 Then scroll down to Password: and enter the password provided by your ISP. Press **OK**.
- 7 The Baud Rate:, Idle Time Out: and Line Type: fields should remain set to 9600, 600 and ISDN respectively.
- 8 To exit the Browser Menu, press **M** twice and then the smart button.
- 9 To store the phone number within the phone, press **M**, then scroll to Phone Book and press **OK**. Scroll to My Phone Number(s), press **OK** and enter your mobile phone number including the + and the country code. For example: +44 then your **phone number**.
- 10 Press and hold the **C** key to exit the Phone Book Menu.

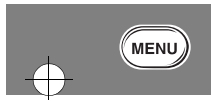

Initialising Your Internet Account for the First Time

To provide the highest level of security for your Internet capable phone, an added security feature has been implemented. Your phone will automatically lock for Internet use with the first SIM card used.

Normal voice calls are NOT affected.

This feature prevents other SIM cards from being used to access your Internet account. This means that if you use a SIM card other than your own during the **FIRST** internet connection, the following procedure must be followed to enable your own SIM to be provisioned.

Before you can start a mobile internet session, you need to contact your ISP to request that your Internet Account be initialized.

- 1 Power **OFF** the phone
- 2 Power **ON** the phone
- 3 Start the browser

The first time you connect you will be prompted to select either:

- 1 Verify Key
- 2 New Key

Choose New Key. You will see the messages Generating))))))) , Computing (((((((followed by a **welcome** message from your ISP. Once the key exchange is complete, you are ready with your new secured key and are ready to start a mobile internet session.



Starting a Mobile Internet Session

 Press **(↑)**. Select the Quick Access feature or after the tone, say the Voice Tag name.

The menu option **Access Internet** starts a mobile internet session. When you start a mobile internet session, you will see the messages **Connecting ...**, **Sending))))** and **Receiving (((((** before your home page appears. Typically, an ISDN connection will take approximately 10 seconds and a modem connection will take 30 seconds.

Using the Mobile Internet Session

Selecting Options Within a Mobile Internet Session

If the Internet page has a list of menu options, scroll up or down to highlight the appropriate menu option and then press **(OK)** to select it. Press **(C)** to return to the previous screen.

When the text for a menu option is too wide for the screen, the phone uses two screens and repeats each half of the menu list until you make a selection.

Editing Text Within a Mobile Internet Session

You edit text in a mobile internet session in a similar way to editing text in all other phone functions, but you can use softkeys to enter symbols and numbers easily. See **Entering Text on Your Phone**.

Making and Receiving Calls During a Mobile Internet Session

To make a call, you must end the mobile internet session and make your call in the normal way.

You can not receive voice calls during an on-line mobile internet session. When an on-line session is in progress, the phone displays the  (In Use) icon. If you receive a call during a mobile internet session the phone diverts the call (see **Call Diverting**).¹

If you receive a call during an off-line mobile internet session (the  (In Use) icon is not displayed) your phone prompts you to **Answer?**. Press **(OK)** to accept the call or press **(C)** to reject it.

If you answer the call, **WAP Session Paused - Resume?** appears when you end the call. Press **(OK)** to resume your mobile internet session or press **(C)** to return to the idle phone display.

Internet Service Alerts

You do not need to be using the mobile internet to receive an internet service alert. If you receive an alert, your phone:

- emits an alert tone (depending on the 'Ringer On or Off' setting)
- displays a pop up screen with appropriate alert details.

Press **(OK)** to display the contents of the alert or press **(C)** to reject it.



1. Availability of this feature depends on your service provider.



Ending a Mobile Internet Session

Press the **C** key repeatedly until the Internet home page appears. Press **C** again to end the mobile internet session. You can also press the smart key to end the mobile internet session. This immediately returns you to the idle phone display.

Summary of Keys Within a Mobile Internet Session

Key action	Effect in mobile internet	Effect in text editor ¹
Press M	Selects the first soft key (Softkey1 in the example).	
Press OK	Selects the second soft key (Softkey2 in the example).	
Press and hold M	Displays the mobile internet menu.	
Press ↔	Ends the mobile internet session.	
Press C	Takes you back to the previous screen.	Deletes the character in front of the cursor.
Press C repeatedly	Takes you back to the Internet home page.	Deletes all the characters in the edit area.
Press C again	Ends the mobile internet session.	
Press 1 ... 9 wxyz	Selects a menu option in a list	Inserts an alphanumeric character.
Press and hold 1 ... 9 wxyz	Takes you to a bookmarked page.	Changes the case for the next alphanumeric character.

Key action	Effect in mobile internet	Effect in text editor ¹
Press ↑ / ↓	Takes you up or down through a list of menu options.	Moves the cursor one position to the left or one position to the right.

1. For full details, see *Entering Text on Your Phone*.

Bookmark List

Setting the List of Preferred Sites

This function is usually available from the WAP Browser menu (option 4: "Mark Site") which can be accessed as described previously. Access to it, however, depends on the type of WAP application and on the type of server features offered by your service provider. This function may not be available in all countries.





The Phone Book Menu

Phone Book

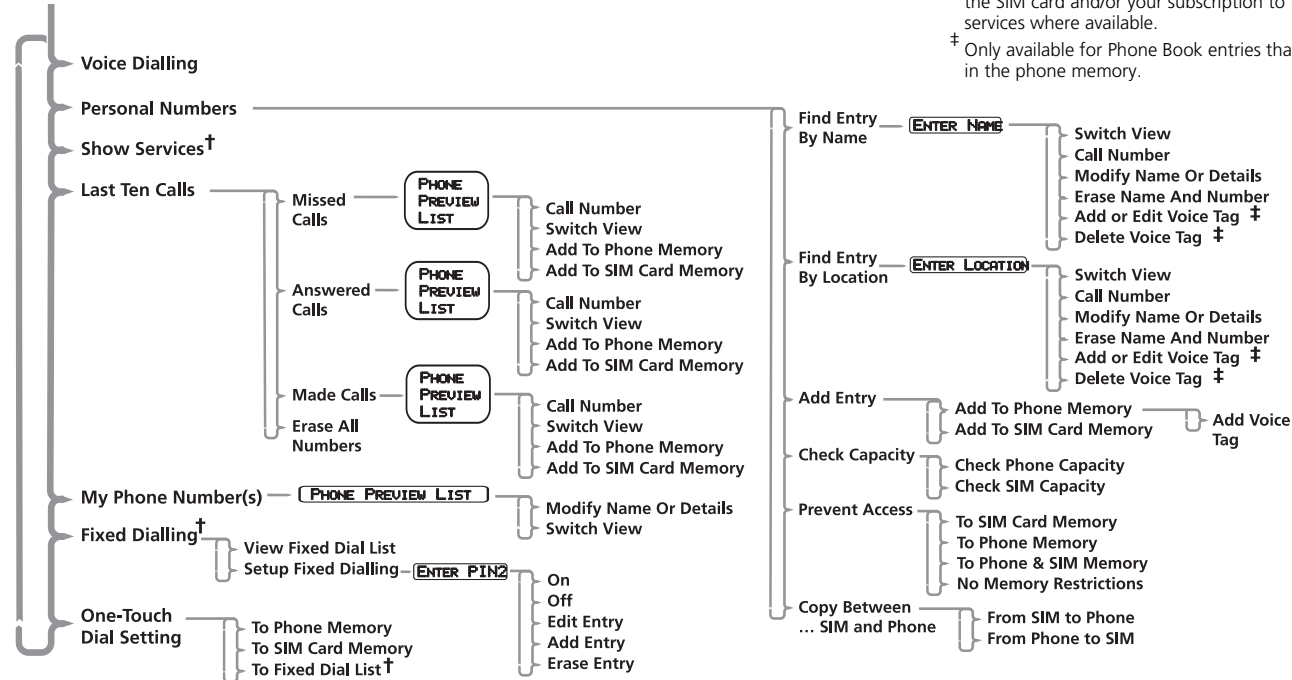

Menu Navigation

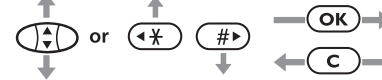

† Availability depends on the type and settings of the SIM card and/or your subscription to these services where available.

‡ Only available for Phone Book entries that are in the phone memory.





OK *What is the Phone Book?*

You can store names and telephone numbers as entries in an electronic 'Phone Book'. These entries are stored in the *Personal Numbers list* in your phone or SIM card's memory, and in the *Fixed Dial list*¹ on your SIM card. Once stored, a number can be quickly retrieved and dialled.

Your phone can store 300 entries and the SIM card can store additional entries (up to the capacity of the SIM card - 8k, 16k) in the Personal Numbers list. The number of SIM card entries will vary depending upon the type of SIM card issued by your Cellular Service Provider.

You can also store up to 40 entries in a Fixed Dialling list if you have this feature. Fixed Dialling allows you to limit use of your phone to particular numbers, or, if you wish, to country codes, area codes, or other prefixes of your choosing.

Each Phone Book entry comprises:

- A telephone number. Up to 32 digits can be stored, but this is reduced to 20 digits for SIM card locations.
- A name. Up to 16 characters for phone locations. Up to 50 characters for SIM card locations, but typically 10 or less.
- A location label - from 1 to XXX in your Personal Numbers list, or 1 to 40 in your Fixed Dial list. The value of XXX is 300 + SIM card capacity. The maximum is 555.

Postscripting

This allows you to make use of area codes and other prefixes previously stored in your Phone Book when making a call.

To use postscripting, select the Phone Book entry containing the prefix and then simply enter the rest of the number and press **OK** to make the call.

You can also use postscripting if you want to call a number similar to one you have stored in your Phone Book. Retrieve the number from the Phone Book, delete the relevant digits and then enter the new number.

 *Postscripting a number does not overwrite the entry in the Phone Book.*

 *Postscripting is not available when accessing the Phone Book using the Smart button.*

1. Availability of the Fixed Dialling feature depends on the type of SIM card you have.



Entering Text on Your Phone

You use the phone keypad (0+, 1) to (9WXYZ) to enter text on your phone. However, there are three different ways to enter text:

iTAP™: Press a key to generate a character and a dynamic dictionary uses this to build and display a set of word or name options. Please note that iTAP™ may not be available on the phone in all languages.

Tap: Press a key to generate a character.

Numeric: The keypad produces numeric characters only. For some text areas, this is the only method available, for example, phone numbers.

This section identifies:

- the characters assigned to each key
- how to select an entry method
- how to use each entry method.

Table of Characters

The table of characters identifies the characters assigned to each key. The top line shows the upper case characters and the lower line shows the lower case characters.

To change from upper case to lower case, or from lower case to upper case, press and hold the appropriate key ((2ABC) to (9WXYZ)).

In iTAP mode, the keys (2ABC) to (9WXYZ) generate standard letters as predicted by the dynamic dictionary, and the numbers 2 to 9. (1) generates all the punctuation and symbols, (0+) generates 0 and 1.

(1)	Space . 1 ? ! , @ _ & : " () ' & i % € \$
	There is no case change for this key.
(2ABC)	A B C 2 Ä Å à å Æ Ø a b c 2 ä å æ ø
(3DEF)	D E F 3 Æ é è d e f 3 æ é è
(4GHI)	G H I 4 Γ i g h i 4 γ i
(5JKL)	J K L 5 Å j k l 5 å
(6MNO)	M N O 6 Æ ö ø ò m n o 6 æ ö ø ò
(7PQRS)	P Q R S 7 Π ϑ Σ p q r s 7 π ϑ σ
(8TUV)	T U V 8 Θ Û Ü t u v 8 θ ù ü
(9WXYZ)	W X Y Z 9 Ξ Ψ w x y z 9 ξ ψ
(0+)	+ - 0 x * / = > < #
	There is no case change for this key.





Selecting a Text Entry Method

You can select a text entry method whenever you need to add or edit text, for example:

- in the phone book (Enter Name, Enter Number)
- in the message editor
- in the mobile internet session.

When you are in area where you need to add or edit text, press **M** to display each of the available entry methods. Press **OK** to select the entry method you require.

If iTAP does not support the current language set up for your phone, then only Tap is available. Your phone displays Not Available when you press **M**.



The factory default for the entry method is Tap Mode. However, you can change the default. See 'Entry Method Selection' in **Phone Setup Menu**.

How to Enter Text in iTAP Mode

Only available if iTAP supports the current language set up for your phone.

In iTAP Mode, each key has a number of different characters assigned to it. When you press a key to start a word, the available characters appear at the bottom of the display.

As you add characters, a dynamic dictionary builds and displays a set of text options along the bottom of the display. iTAP highlights the first choice text option.

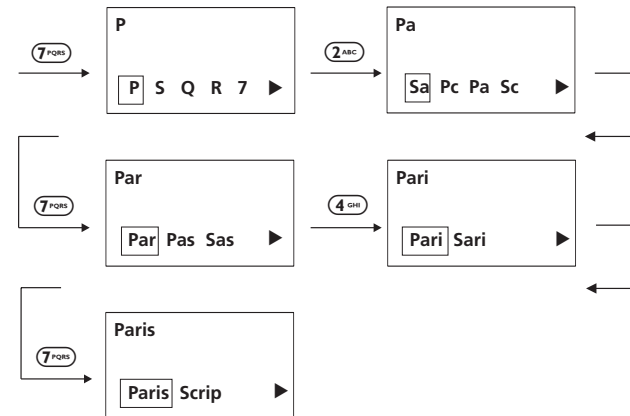

To highlight and add characters to an alternative text option, press **↑** or **↓**. A left or right arrow on the bottom line indicates that **↑** or **↓** will display more text options.

When you are ready to add a highlighted word to the main display area, press **OK**.

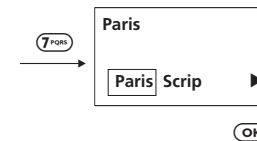

To start adding another word, press the next text key you require. However, if you have finished editing, select **OK**.



iTAP - Locking a Word

You lock a word to give yourself a better selection of text options or to stop the dynamic dictionary from changing the core text you are using. The core text can change if you create a word that is not in the dynamic dictionary.

You can lock a word in two ways:

- Use or to highlight an alternative text option (even if you then return to the original text option). The highlighted text then forms the basis for all subsequent text options.
- Use to return to the core text you require. For example you add t to Por but iTAP changes the text option to Part. If you press and highlight Por, Por is then locked.

iTAP - Punctuation and Upper Case Characters

When you select a word to go into the main display area, iTAP automatically inserts a space. However, iTAP does not necessarily add a space if you insert a punctuation character, for example, a period.

Press to add a punctuation character or symbol.

iTAP automatically adds an upper case character: at the beginning of a message; at the beginning of a sentence; and at the beginning of each word in the phone book.

To insert upper case characters at any other time, press and hold the appropriate key (to .

iTAP - Adding Numeric Characters

When you press a key, the numeric character assigned to the key appears as one of the alternative text options. Once you highlight a numeric character, all subsequent characters are numeric until you press .

iTAP - Correcting Text

In iTAP Mode, you can correct the text in the main display area. You can delete one character at a time or one word at a time.

To move the cursor (|), press or .

To delete the character before the cursor, press . You can then insert any new characters you require.

To delete the word before the cursor, press and hold . If you continue to press , you delete the next word, and so on, until you delete all the words.

iTAP - The Dynamic Dictionary

The dynamic dictionary learns the most recent and the most frequent words that you use. This includes names and acronyms. If there are words that you do not use frequently, then the dynamic dictionary deletes these first to make room for new words or words that are more frequently used.

The language you specify for the phone determines the dynamic dictionary that it uses (if there is one is available). See 'Language Selection' in **Phone Setup Menu**.

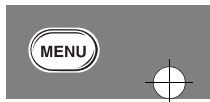



How to Enter Text in Tap Mode

In Tap Mode, each key has a number of different characters assigned to it. See 'Table of Characters'. When you press the same key several times, you scroll through the assigned characters.

For example, if you press **5**, you display the J or j character. If you press the same key again, you display the K or k character, and so on.

To enter the next character, press the next key that has the character you require. If the next character is on the same key, you must first press **↓**.

Correcting Text

In Tap Mode, you can delete one character at a time or you can delete all the text.

To move the cursor (I), press **↑** or **↓**.

To delete the character before the cursor, press **C**. You can then insert any new characters you require.

To delete all the text, press and hold **C**.

How to Enter Text in Numeric Mode

The keys **0***, **1** to **9** produce numeric characters only.

Correcting Text

In Numeric Mode, you can delete one character at a time or you can delete all the text.

To move the cursor (I), press **↑** or **↓**.

To delete the character before the cursor, press **C**. You can then insert any new characters you require.

To delete all the text, press and hold **C**.

Voice Dialling

Select this option to call any phone number that has a Voice Tag.

The phone prompts you to press the smart button **☎**. See

Using Voice Activation.

Personal Numbers

The Personal Numbers sub-menu is used for creating and managing your list of personal numbers.

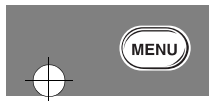



Find Entry By Name

Press **[OK]** and say the Voice Tag name after the tone.

Press **[OK]** and use the volume button to scroll to the stored number, or press the appropriate digit key to skip to a particular letter. To make the call, either hold down **[OK]** for 1.5 seconds or press **[OK]**.

This option is used to select a telephone number from a list of alphabetically sorted Phone Book names.

Once selected, this option will display the message Enter Name. You can enter a maximum of three characters from a name but you do not need to enter all three characters to begin a search.

The Phone Book entries will be searched and the first alphabetically matching entry will be displayed.

If there isn't a name matching your entry, the nearest alphabetically matching entry will be displayed.

If you do not enter any name information, the first alphabetical entry will be displayed.

If there are no names stored, No Names Stored will be displayed.

To display adjacent Phone Book entries use the **[Left/Right]** key. When the desired name is displayed press the **[OK]** key to select it. The phone then enters the options sub-menu for Find Entry By Name. See 'The Options for 'Find Entry By ...''.

Find Entry By Location

Press **[OK]** and say the Voice Tag name after the tone.

Location **[#>]**

This option is used to select a telephone number from a list of numerically sorted Phone Book locations.

Once selected, this option will display the message Enter Location. You can now enter a location number. If the entered location is not valid, a timed message Range 1-XXX will be displayed and the phone will return to the Enter Location menu item. The value of XXX is 300 + SIM card capacity. The maximum is 555.

The Phone Book entries will be searched and an entry will be displayed.

If you enter a location number for which there is no entry, Location XXX Empty will be displayed and the nearest non-empty location will be selected instead.

If you did not enter a location, the first numerical entry will be displayed.

If there are no numbers stored, No Numbers Stored will be displayed.

To display adjacent Phone Book entries use the **[Left/Right]** key. When the desired name is displayed press the **[OK]** key to select it. The phone then enters the options sub-menu for Find Entry By Location. See 'The Options for 'Find Entry By ...''.





The Options for 'Find Entry By ...'

Once a Phone Book entry has been selected, it can be called, modified or deleted.

If the Phone Book entry is in phone memory, you can also add, edit or delete the Voice Tag.

Call Number

This option is used to call the selected Phone Book telephone number.

Modify Name or Number

This option is used to change the selected Phone Book entry.

The entry's current telephone number and name will be presented, in turn, for modification. You can accept the current settings or modify as required.

Erase Name and Number

This option is used to erase the selected Phone Book entry.

Simply press the **OK** key when the phone displays the message *Erase Name And Number*. The option will display the timed message *Erased XXX* and then return to the *Find Entry* menu item.

Add or Edit Voice Tag and Delete Voice Tag

Use these options to add, edit or delete the Voice Tag for the Phone Book entry. See *Using Voice Activation*.

Add Entry

 Press **↑**. Select the Quick Access feature or after the tone, say the Voice Tag name.

This option is used to add (store) entries to the Phone Book. You can choose to add the new entry to either the phone or SIM card memory locations.

Add To Phone Memory, Add To SIM Card Memory

Once you have selected the destination of the new entry, you will be asked to enter the telephone number, name and location number of the new entry.

The last telephone number displayed will be presented by default; it can be used or discarded as required.

If the entered location is not valid, a timed message *Range YYY-ZZZ* will be displayed and the phone will return to the *Enter Location* prompt. If the chosen location is currently used by another entry, you will be asked for confirmation that the location can be overwritten.

If you do not supply a location number, the next available location will be used.

When the new entry has been entered, a timed message *Stored XXX* will be displayed.

Add Voice Tag

If you add a Phone Book entry to the phone memory, the *Add Voice Tag?* prompt appears after *Stored XXX*. Press **OK** to add a Voice Tag. See *Using Voice Activation*.

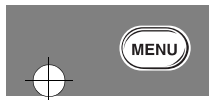



Check Capacity

This option is used to check the number of free Phone Book entries in the phone or SIM card memory areas.

Check Phone Capacity, Check SIM Capacity

Once selected, a timed message **XX Unused Locations** displays the requested information.

Prevent Access

This option enables you to prevent access to the Personal Numbers list.

You cannot record a Voice Tag if you have set Prevent Access To Phone Memory.

To SIM Card Memory, To Phone Memory, To Phone & SIM Memory, No Memory Restrictions

You can prevent access to all entries in the SIM card memory, the phone memory or both the phone and SIM card memory. To cancel all access restrictions use the No Memory Restrictions option.

When you change the restrictions, you will be requested to enter the Security Code before the change is made. See **New Security Code**.

Copy Between SIM and Phone

This feature allows you to copy entries from the SIM Card to the phone and from the phone to the SIM card. You can also copy entries between SIM cards. First, copy the information from the SIM Card to the phone. Next, replace the SIM Card with the new one you want to copy to. Finally, copy the information from the phone to the SIM Card.

From SIM to Phone

This option allows you to copy entries from the SIM Card to the phone. You can specify either to copy all entries or to copy by specific location.

From Phone to SIM

This option allows you to copy entries from the phone to the SIM card. You can specify either to copy all entries or to copy by specific location.

Show Services

Press **(↑)**. Select the Quick Access feature or after the tone, say the Voice Tag name.

This option displays a list of phone numbers and services provided by your Cellular Service Provider.

Availability depends on the type and settings of the SIM card, and/or your subscription to this feature.

Last Ten Calls

These options allow you to review your last 10 most recently missed calls, answered calls and called phone numbers, and the time and date information associated with the call. Depending on the option you choose, you can then redial a phone number, store a phone number in your phone book, or erase all of the phone numbers.

After you select an option, use the **(↓)** key to scroll through the list of phone numbers. Press the **(OK)** key to proceed.





You can use postscripting to modify a number once you have retrieved it from either of the Last Ten Calls lists.

Missed Calls

Press . Select the Quick Access feature or after the tone, say the Voice Tag name.

This option displays the last 10 calls which were unanswered by the user along with the time and date. Select this list item to call the number, add it to phone or SIM card memory. If the number matches an entry on your phone or SIM card memory, the name attached to the number will be displayed in the Missed Call List.

You will only see the incoming phone numbers in the Last Calls Missed and Answered Calls lists if you have Caller Line Identification.

When you scroll through your last ten calls, each call appears with a call position number. Press the key to select a phone number. You can then scroll through and select one of the following options:

Call Number

Select this option to call the phone number.

Switch View

Select this option to see more details for the selected item. The details include the name, number, time and date. Select **Switch View** again to return to the previous screen.

Add to Phone Memory

Select this option to add all the phone number details (including any details you have added) to your phone memory. If the name in the received call does not appear in your phone book, the phone prompts you to **Enter Name** and **Enter Location**. For further details, see 'Add Entry' in this section.

Add to SIM Card Memory

Select this option to add the phone number details (including any details you have added) to your SIM card memory. If the name in the received call does not appear in your phone book, the phone prompts you to **Enter Name** and **Enter Location**. For further details, see 'Add Entry' in this section.

Answered Calls

This option displays the last 10 answered calls and the time and date on which the call was received. Select a number to either call the number, or add it to phone or SIM card memory. If the number matches an entry in your phone or SIM card memory, the name attached to the number will be displayed in your Answered Calls list.

Made Calls

This option displays the last 10 calls made and the time and date on which the call was made. If the call was made from the phone or SIM card memory, the associated name will be displayed. Otherwise, only the number dialled will be shown.





Erase All Numbers

This option erases all the numbers stored in your Last 10 Calls Missed, Answered and Made lists.

The Last Ten Calls lists will be erased when a new SIM is inserted in the phone.

My Phone Number(s)

This option allows you to access your cellular phone, fax and data numbers so that you can retrieve or modify them when required. For example, if you have difficulty remembering your cellular phone number, store it with the name **My Phone** and then you will be able to retrieve the number as required.

The My Phone Number(s) list is stored on your SIM card.

When you select this item, the first location will be displayed. Use the key to scroll through the phone numbers stored.

To enter or change a number, scroll to the location and press **OK**. You will be prompted to enter a phone number and then a name. Press **OK** to store the information.

Depending on your Cellular Service Provider, you may find that one or more of the entries in the My Phone Number(s) list will have been defined. You may not be able to change these predefined entries.

Fixed Dialling

Availability of the Fixed Dialling menu depends on the type of SIM card.

This feature allows you to limit use (typically third-party use) of your phone to a predefined list of telephone numbers or, if you wish, to a list of country codes, area codes, or other prefixes of your choosing.

When Fixed Dialling is switched on, the only numbers that can be dialled from your phone are those stored (or whose prefix is stored) in the Fixed Dial list. If you attempt to dial any other number (apart from an emergency number), the message **Restricted** will be displayed. You will not be able to make fax or data calls.

To make a call when Fixed Dialling is switched on, either dial the number manually, or select it from the Fixed Dial list and press **OK**.

Up to 40 entries can be stored in the Fixed Dial list. The list is stored on your SIM card.

This option may be affected by the Call Barring setting.

View Fixed Dial List

This option allows you to scroll through the numbers in the Fixed Dial list. When you find the number you want, press **OK** to make the call.





Setup Fixed Dialling

This option allows you to switch Fixed Dialling on or off and to enter or change entries in the Fixed Dial list.

You will be prompted to enter your PIN2 security code when you select this option.

On

Switches fixed dialling on.

Off

Switches fixed dialling off.

Edit Entry

Modifies or clears an entry in the Fixed Dial list. When you select this option, the first non-empty location in the list will be displayed. Scroll to the entry you want to change and press **(OK)**. You will be prompted to edit the phone number and the name. To erase the entry, press **(C)**.

Add Entry

Adds a phone number and name to the Fixed Dial list. When you select this option you will be prompted to enter the phone number, name and a location number. If you do not specify a location number, it will be stored in the next available location.

When setting up your Fixed Dial list, you may want to reserve the first nine locations for phone numbers you wish to One-Touch Dial. See also One-Touch Dial Setting.

Erase Entry

Erases a phone number and name from the Fixed Dial list. The first entry in the Fixed Dial list will be displayed. Scroll to the entry you wish to delete and press **(OK)**.

One-Touch Dial Setting

This option allows you to specify which Phone Book list can be One-Touch Dialed.

To Phone Memory

Switches One-Touch Dialling to your Personal Numbers list stored in phone memory (locations 1 to 9).

To SIM Card Memory

Switches One-Touch Dialling to your Personal Numbers list stored on your SIM card (locations 101 to 109).

To Fixed Dial list

This option is only available if you have Fixed Dialling.

Switches One-Touch Dialling to your Fixed Dial list (locations 1 to 9).





The Date Book Menu

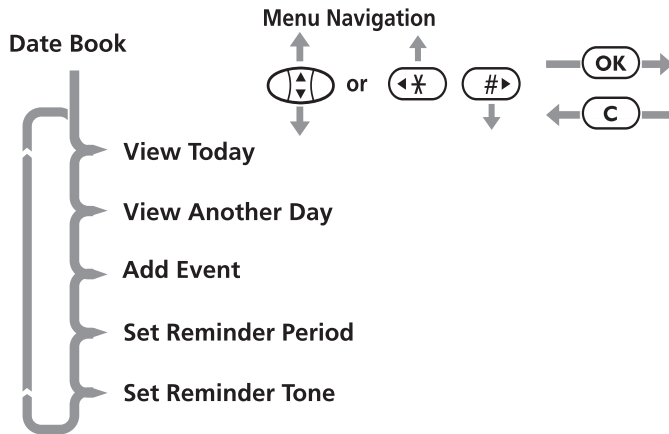

About Date Book

This feature allows you to put your schedule into your phone. You can enter your schedule either through the phone or through the computer.

The alarm icon will be set to show any alarms set up for any events in the Date Book.

To enter your schedule through your computer and synchronise it with your phone, you will need TrueSync™ Desktop installed in your computer. You will also need either an infra-red port or an RS232 Serial Data Cable in your computer. Refer to the

TrueSync™ Quick Start Guide on how to install the TrueSync™ Desktop in your computer.

View Today

This option allows you to view your schedule for the day. You can also view other days events up to 2 weeks in the past and any day in the future by pressing the button.

Press **OK** to view the events. The events are sorted by time with the earliest event shown first.

Use the button to scroll through the events.

View Another Day

This option allows you to view events on a specific day by entering the specific date.

Add Event

This option allows you to set up an event. You can set up the date, the start time and the duration of the event. You can also set up a reminder for the event.

You can schedule up to 1000 events.

Set Reminder Period

This option allows you to set the time you want to be reminded before a scheduled event.

For example, if you set an event for 10 am and a reminder period of 15 minutes, the alert will be sounded at 9:45 am and the alarm icon will be displayed for 15 minutes until the start time of the event at 10am.





If there is a reminder for another event that falls within the duration of the previous event, this will also sound the alert once as set and the icon will continue displaying for that reminder period.

When a reminder is set, the phone will set off an alarm. The default reminder period is 15 minutes.

When the alarm is set off, you will be prompted to view the scheduled event. You can also scroll through the previous events for the day.

The alarm is not set off if the phone is set to No Ring Or Vibrate mode.



Set Reminder Tone

This option allows you to set a tone to differentiate the tones between SMS and ringer tone.

The tone will be replaced by vibrate if the phone is set to Vibrate Only and Vibrate Then Ring mode.

Even if the reminder is set to Vibrate, it will still ring if the phone is connected to a charger.



Call Related Features Menu

Menu Navigation

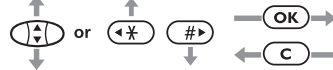

Items shown in *italics* are available only when **Extended Menus** are switched on.

† Availability depends on the type and settings of the SIM card and/or your subscription to these services where available.

\$ Only on phones with a flip.

Call Related Features

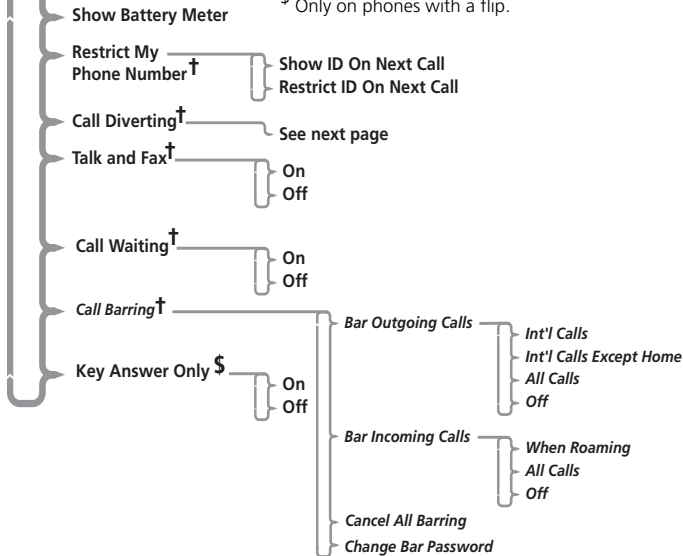

Show Battery Meter

This option displays the approximate amount of battery capacity remaining, for example:

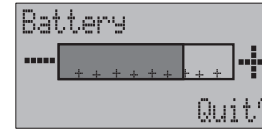

Number of Segments

Approximate Charge Level

1	less than 5% (recharging needed)
3	less than 20%
5	less than 60%
7	greater than 60%

Press . Select the Quick Access feature or after the tone, say the Voice Tag name.



Restrict My Phone Number

'Restrict My Phone Number' is a network feature. You will need to subscribe to one of the two Caller Line Identification restriction features with your Cellular Service Provider.

Show ID on Next Call

Your phone number is sent with the next attempted call, after this your phone number will not be sent until you re-select this option.

Restrict ID on Next Call

Press . Select the Quick Access feature or after the tone, say the Voice Tag name.



Your phone number will not be sent with the next attempted call, after this your phone number will be sent with calls until you re-select this option.

OK Call Diverting

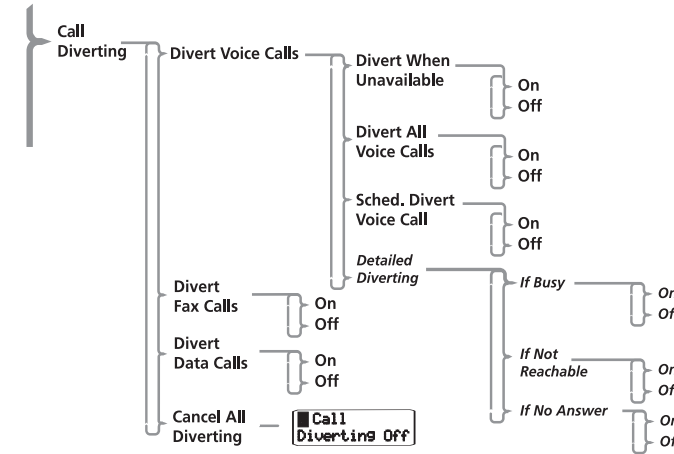

Call diverting is a network feature. If your phone is unavailable, or you do not wish to receive calls, incoming calls can be diverted to other phone numbers.

This option can be used to:

- Divert all incoming Voice calls unconditionally.
- Divert all incoming Voice calls at user scheduled times.
- Divert incoming Voice calls whenever your phone is unavailable, busy, not reachable or not answered.
- Divert incoming Fax calls.
- Divert incoming Data calls.



- Reset all diversion options to off.

You cannot change the call divert settings when you are out of network coverage.

After selecting any of the call divert options there will be a short delay while the phone asks the network for the current setting.

During Call Diverting, Answering Machine is not available.

Divert Voice Calls

This option will allow you to set your phone to *Divert When Unavailable*, *Divert All Voice Calls* or *Detailed Diverting*.

Divert When Unavailable

This option will enable you to divert all incoming Voice calls to a single number, whenever your phone is unavailable.

The option has two settings, On or Off.

If you change the setting to On, you will be asked to enter a diversion phone number using the digit keys.

Setting "Divert When Unavailable" to On will have the same effect as setting all "Detailed Diverting" options to On.

When On, Divert When Unavailable takes priority over detailed diversion settings.

Divert All Voice Calls

Press (↑). Select the Quick Access feature or after the tone, say the Voice Tag name.

This option will enable you to *unconditionally* divert all incoming Voice calls to a single number.

The option has two settings, On or Off.

If you change the setting to On, you will be asked to enter a diversion phone number using the digit keys.

To use the Quick Access option, you must have a diversion phone number set up.

When On, Divert All Voice Calls takes priority over all other Voice call diversion settings.

Scheduled Diverting

This feature will not operate when the phone is powered OFF.

This option will allow you to select the days and times during which all voice calls will be diverted to a single number. This option has 2 settings: On or Off. If you change the setting to On, you will be asked to select when you want your calls diverted.

Your call can be diverted daily, on a specific day every week, every Monday to Friday, every Monday to Saturday. Use the digit keys to specify the exact times during which you want all your calls diverted.

To complete the setting, use the digit keys to enter the diversion phone number.

If you attempt to set another voice divert feature (For Example: Divert when Unavailable, Divert All Voice calls, Detailed Diverting) when Scheduled Diverting is active, the Scheduled Diverting settings will be overwritten by your new settings.





When you perform a manual call divert while scheduled call divert is selected, the scheduled call divert is turned off. The same also happens when you change the time settings for the phone while scheduled call divert is active.

Detailed Diverting

These options will enable you to divert Voice calls to different numbers, depending upon the current status of your phone.

Each of the following detailed diverting options operate in the same way.

Each option has two settings, On or Off.

If you change the setting to On, you will be asked to enter a diversion phone number using the digit keys.

Detailed diversion settings are ignored while Divert All Voice Calls or Divert When Unavailable are On.

If Busy

This option will divert incoming calls if your phone is busy.

If Not Reachable

This option will divert incoming calls if your phone cannot be contacted by the network.

If No Answer

This option will divert incoming calls if you do not answer the call.

Divert Fax Calls

This option will enable you to divert all Fax calls to a single number.

The option has two settings, On or Off.

If you change the setting to On, you will be asked to enter a diversion phone number using the digit keys.

Divert Data Calls

This option will enable you to divert all Data calls to a single number.

The option has two settings, On or Off.

If you change the setting to On, you will be asked to enter a diversion phone number using the digit keys.

Cancel All Diverting

This option will enable you to cancel the diversion of incoming calls.

This option resets all diversion settings to Off and removes all diversion numbers.

Talk and Fax

This is a network feature that allows you to speak and then send or receive a fax during the course of a single call.

Your phone supports a data and fax transmission speed of up to 9.6 kbps.

Before making a Talk and Fax call, ensure that:

- Your phone is "fax-ready" (it has been switched off, connected to the fax with one of the optional data/fax accessories, then switched back on). Connecting your phone to the fax in the middle of the call will not work.
- The Talk and Fax mode is set to On.





A Talk and Fax call automatically switches to fax mode when you start sending the fax. While the fax is being transmitted, the message Fax In Progress will be displayed. The call automatically ends when the fax transmission is complete. You cannot switch back to voice mode in the same call.

While a Talk and Fax call is active, any incoming call and services like Call Waiting and Call Holding are suspended.

If you receive a Talk and Fax call when:

- Your phone is not fax-ready - you can only talk.
- Your phone is fax-ready but Talk and Fax mode is off - the call is automatically routed to your fax (you cannot talk).

On

Switches Talk and Fax mode on for the next and all subsequent calls.

Off

Switches Talk and Fax mode off for the next and all subsequent calls.

When you deactivate the Talk and Fax call, power off and on your phone in order to resume any incoming call and services like Call Waiting and Call Holding.

OK Call Waiting

The Call Waiting menu item has two settings On or Off. If you select Off, you will not be notified of waiting calls. The person trying to contact you will either receive the busy tone, or be diverted by the 'Detailed Diverting - If Busy' option.

If Call Waiting is On, you will be notified of a waiting call by an audible alert and by the message Call Waiting - Answer?. You can press the **OK** key to accept the waiting call, or use the **M** and then the **Left Arrow** key to scroll to an alternative option and then press **OK**.

If you have Caller Line Identification, the caller's number or name is displayed instead of the Call Waiting message.

Availability of this feature depends on your service provider.

OK Call Barring

Call barring is a network feature which can be used to selectively bar outgoing and incoming calls.

If you change the barring setting, you may be asked to enter your barring password. There will be a short delay while the phone notifies the network of the new setting. When the change has been made by the network, the phone will display a confirmation message.

The *initial* password will be supplied to you by your Cellular Service Provider when you subscribe to this service.

This option may be affected by the Fixed Dialling setting.

Bar Outgoing Calls

After selecting this option, there will be a short delay while the phone asks the network for the current setting.

Int'l Calls

When selected, this option will bar outgoing international calls.





Int'l Calls Except Home

When selected, this option will bar outgoing international calls, except those to your home country.

All Calls

When selected, this option will bar all outgoing calls, except emergency calls.

Off

When selected, this option will disable all call barring for outgoing calls.

Bar Incoming Calls

After selecting this option, there will be a short delay while the phone asks the network for the current setting.

When Roaming

When selected, this option will bar incoming calls when you are roaming.

You may wish to select this option, as some Cellular Service Providers charge an additional fee for receiving calls when you are roaming.

All Calls

When selected, this option will bar all incoming calls.

Off

When selected, this option will disable all call barring for incoming calls.

Cancel All Barring

This option can be used to set all Call Barring options to Off.

Change Bar Password

This option can be used to change the call barring password.

After selecting this option, you will be asked to enter the current password.

You will then be asked to enter, and then re-enter, your new, **4 digit**, barring password. When the change has been made by the network, the phone will display a confirmation message.

OK Key Answer Only

This option is only available if you have a phone with a flip.

This features has two options: On or Off.

When set to On, this feature allows the flip to be opened without answering an incoming call. The call can be answered by pressing an appropriate key (OK, I to WXYZ, *, or #). To reject the call press C.

When set to Off, opening the flip answers an incoming call.





Messages Menu

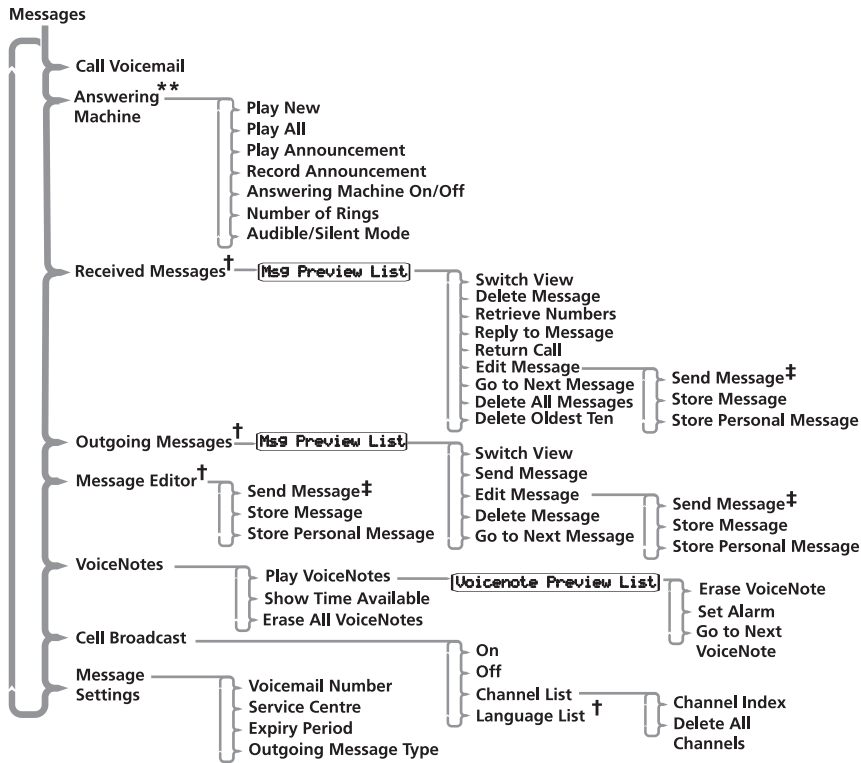

Menu Navigation

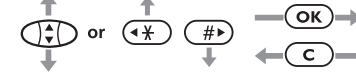

† Availability depends on the type and settings of the SIM card and/or your subscription to these services where available.

‡ See 'Send Message' option in 'Outgoing Messages' section.

**This feature is not available in all countries







Your phone supports the two GSM message features: Short Message Services (SMS) and Cell Broadcast.

SMS Messages

These are text messages that are sent specifically to and from your phone number.

When an SMS message is received, your phone:

- 1 Makes three short alert tones (depending on the 'Ring or Vibrate' setting).
- 2 Displays the  (messages) icon.
- 3 Stores the message for later viewing, if there is space. If there is not enough space, the  icon will flash. One or more messages must be removed before the message can be stored.

Your Cellular Service Provider will transmit a message for a limited amount of time. If a memory location is not made available before the message is removed from the network, then you will not be able to receive or read it.



- 4 Displays the received message animation together with the word *Message* and the prompt; *Read Now?*
 - Press **OK** to display the viewing a message animation and the contents of the new message.
 - Press **C** to return to the screen that was present before you received the message.
 - Press any other key to perform the function linked to that key.



If you do not press a key, then after 1 minute the display returns to the screen that was present before you received the message.

Cell Broadcast Messages

These are general messages that your service provider broadcasts to all phones in a geographic area. Your phone can only receive a cell broadcast message when it is in idle mode.

The messages are broadcast in numbered 'channels'. For example, channel 050 might be for local weather, traffic reports or stock market prices. Please contact your service provider for a list of available channels and the information they provide.

While a broadcast message is scrolling across the display, you can stop and start it by pressing . Press  to restart the message from the beginning. If you want to remove the message from the display, press **C**.

 *If you need to use the  and  keys for their normal functions while you are receiving a cell broadcast message, you must first remove the message.*

When the message has scrolled across the display, the beginning of the message remains until one of the following occurs: you remove it; a new message arrives; or you leave the geographic area. For set up details, see **Cell Broadcast**.

How to Read SMS Messages

You can use the scroll key () to scroll through messages in either the Received Messages or Outgoing Messages lists.

To display a specific message, enter the message number, for example press **5** to display the 5th message. If the message does not exist, *Invalid Mes Number* will be displayed.

Alternatively, to display the next message, press **OK** and select *Go to Next Message*.





How to Create and Edit SMS Messages

Use the *Message Editor* to create or modify text messages. When you enter the editor, the last message that was edited will be displayed. Press and hold **(C)** to clear the message and start a new one, or modify the message displayed. For an explanation of how to enter text, see *Entering Text on Your Phone*.

Press **(OK)** once you have completed your message. You will then be presented with the following options:

Send Message - If you select this option you will be prompted for a phone number, enter the number and then press **(OK)** to send the message.

Store Message - Select this option to store your edited message in your *Outgoing Messages* list.

If you don't store the message after it has been edited, you will lose all your changes as soon as you select another message to be edited.

OK Call Voicemail

Press **(↑)**. Select the *Quick Access* feature or after the tone, say the *Voice Tag* name.

This option will make a call to the current voicemail number. You can also press **(Ⓜ)** to call the Voicemail number.

The voicemail number is entered using the 'Voicemail Number' option in the *Message Settings* menu.

OK Received Messages

Press **(↑)**. Select the *Quick Access* feature or after the tone, say the *Voice Tag* name.

This option is used to view and manage any SMS messages that have been sent to your phone number.

When selected, this option will display a message indicating the total number of messages and how many of these are new. If there are no messages *No Messages* will be displayed.

If there are messages, the phone then displays the open envelope animation and the contents of the first message. The new messages appear first.

Press **(Ⓜ)↑**, **(Ⓜ)↓** to display the whole message; when it was sent; and the phone number that sent it (if available). The viewing a message animation repeats for each new page.

Once you have read a new message it will automatically become old.

See *How to Read SMS Messages*, for more information on navigating through the messages.

Press the **(OK)** key, when viewing any message, to enter the sub-menu.

Switch View

This allows you to see the full setting details for the selected alarm. Select *Switch View* again to return to the previous screen.

Delete Message

This option will delete the currently viewed message





Retrieve Numbers

This option allows you to retrieve all numbers embedded inside a SMS message. You can perform one of the following: call the number, or store it into your phone or SIM card memory.

If the number is more than 20 characters long (32 characters for GSM1900), the remainder digits will be automatically removed. Any non-numeric characters in the number will be treated as delimiters. A space character or a '-' character occurring in the number string will be ignored. If there is no number found to retrieve within the SMS message, you will see No Number Available message.

Reply to Message

This option allows you to reply with a message.

Return Call

This option can be used to call the person who sent you the message, if their number has been included by the network, or a number that has been included in quotes "" in the message.

Edit Message

This option allows you to use the Message Editor to edit the selected message and then to either send the modified message and/or store it in your Outgoing Messages list. See *How to Create and Edit SMS Messages*, for more information on using the Message Editor.

Go to Next Message

This option displays the viewing a message animation and the next received message.

If you are currently reading the last message in your list then this option will take you back to the top of the list.

Delete All Messages

This option allows you to delete all received messages whether they have been read or not.

Delete Oldest Ten Messages

This option allows you to delete the last ten messages whether they have been read or not.

Once deleted, messages are NOT retrievable.

Received Ringer Tone SMS Message

You can exchange (send and receive) user composed ringer tones via SMS messages between compatible Motorola phones. When a ring tone is received via SMS, you can play the tune, save it to the phone memory or delete it.

Save

This option allows you to save the incoming ring tone to your phone memory.

The newly saved tune will replace the existing user composed tune (Music Tone) in your phone memory.

Play

This option allows you to play and listen to the received ringer tone.

Delete

This option will delete the current selected ringer tone SMS message.





Outgoing Messages

Press **(↑)**. Select the Quick Access feature or after the tone, say the Voice Tag name.

This option is used to view and manage any outgoing messages. These messages will be stored on your SIM card.

When you select this option, your phone displays the total number of messages. If there are messages, your phone displays the viewing a message animation and the first message in the list.

You cannot send an outgoing message until the Message Service Centre number has been set. See *Message Settings*.

Press the **(OK)** key, when viewing any message, to enter the sub-menu. See *How to Read SMS Messages*, for more information on navigating through the messages.

Switch View

This option allows you to see the full setting details for the selected alarm. Select **Switch View** again to return to the previous screen.

Send Message

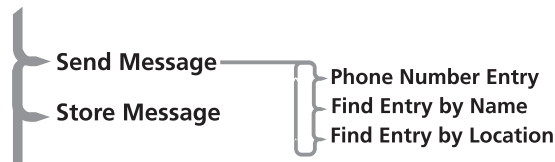

This option allows you to add the destination phone number using a sub-menu.

Using the scroll keys you can select:

Phone Number Entry - this allows you to manually enter the phone number using the keypad and send the message.

Find Entry by Name - this allows you to recall a phone number from the Phone Book by name and send the message (see 'Find Entry By Name' in *The Phone Book Menu* section).

Find Entry by Location - this allows you to recall a phone number from the Phone Book by location and send the message (see 'Find Entry By Location' in *The Phone Book Menu* section).

When you have set up a destination phone number, select **(OK)** to send the message. The phone displays the sending a message animation until you press **(OK)** to confirm that you are sending Message.

Edit Message

This option allows you to use the Message Editor to edit the selected message and then to either send the modified message or store it in your Outgoing Messages list. See *How to Create and Edit SMS Messages*, for more information on using the Message Editor.

Delete Message

This option will delete the currently viewed message.



Go to Next Message

This option displays the viewing a message animation and the next outgoing message.





Message Editor

 Press . Select the Quick Access feature or after the tone, say the Voice Tag name.

The Message Editor is used to edit the currently selected message and then to either send the modified message or store it in your Outgoing Messages list. See *How to Create and Edit SMS Messages*, for more information on using the Message Editor.



VoiceNotes

The VoiceNotes™ feature allows you to record a number of personal voice messages or to record conversations during a phone call. You can selectively delete your VoiceNotes™ or erase them all at once. You can also tag an alarm to a VoiceNote™ and have it play back to remind you when the alarm expires. See *Using VoiceNotes™*, for more information.

Answering Machine¹

This feature allows the caller to record messages in your phone when the call is not answered after a specified number of rings.



The caller will hear an announcement, which you can personalise, followed by a beep to indicate the start of the recording. Recording ends when the caller terminates the call or when the phone runs out of memory.

You can answer the call at any time by pressing . To disconnect the call, press .

1. This feature is not available in all countries.



 This feature is not available when:

- there is an incoming call and a recording is already in progress
- there is an incoming call and you are already in a call
- voice call is diverted or if you have subscribed to Voice Mail.



 The Answering Machine icon () lights if there is any unread voice messages. It is turned off when all messages are read.

 The duration of VoiceNote™ together with Answering Machine should not exceed 3 minutes.

Play New

This option plays all the new messages, that is, messages which have not been played before. Use  and  keys to scroll between messages.

Play All

This option plays all messages, both new and old. Use  and  keys to scroll between messages.

Play Announcement

This option plays the announcement the caller will hear.

Record Announcement

This option allows you to record, up to 10 seconds, your own personalised announcement.

On

Select  to activate this feature.

Off

Select  to deactivate this feature.



Number of Rings

This option determines the number of rings before Answering Machine is activated. The valid range is between 1 and 9 rings.

Audible Mode

In this option, the announcement and caller's message is echoed through the phone speaker.

Silent Mode

In this option, the announcement and caller's message is not echoed.

Cell Broadcast

This option determines the cell broadcast settings. See also *Cell Broadcast Messages*.

On

Select **On** to receive cell broadcast messages. You must then use **Channel List** to specify the appropriate channels.

Off

When you select **Off**, you do not receive any cell broadcast messages and you automatically delete all existing cell broadcast messages.

Channel List

Select either **Channel Index** or **Delete All Channels**.

Channel Index

This option allows you to select up to five different channels for receiving cell broadcast messages. If you modify a channel, you also remove any message associated with it.

Use **<#>**, **>#>** to highlight the channel index you require (1-5)

and then press **OK**. The phone prompts you to Enter Channel.

Type in the channel number and press **OK**. The phone stores the channel details and returns you to the channel index list.

Please contact your service provider for a list of available channels and the information they provide.

Delete All Channels

This option deletes all the channels and all the existing messages.

Language List

 *Availability depends on the type and settings of the SIM card, and/or your subscription to this feature where available.*

This option allows you to select different languages for Cell Broadcast messages. See also *Language Selection* in the **Phone Setup Menu**.

Message Settings

Voicemail Number

This option is used to enter a phone number which will be used by the 'Call Voicemail' option.

If there is already a Voicemail Number, this will be shown in the display. This can be used, modified or deleted as desired.

Service Centre

Before you can send any messages you must use this option to enter your Message Service Centre number. This number is obtained from your Cellular Service Provider.





If there is already a Message Service Centre number, this will be shown in the display. This can be used, modified or deleted as desired.

Expiry Period

You can use this option to specify the maximum time, in hours, that your unforwarded messages are to remain with the Message Service Centre before being deleted. When you select this option, the current expiry period will be displayed (the default is 24 hours).

The maximum value you can enter is 10584, though the real limit will depend on your Message Service Centre.



Outgoing Message Type

This option is network dependent and can be used to specify the format of your outgoing messages. You can select from the following message types: Text (default), Fax, X400, Paging, E-Mail, ERMES or Voice.

 *You do not need to select Voice to send messages to Voicemail boxes.*



Phone Setup Menu

Phone Setup
(Extended Menus - Off)

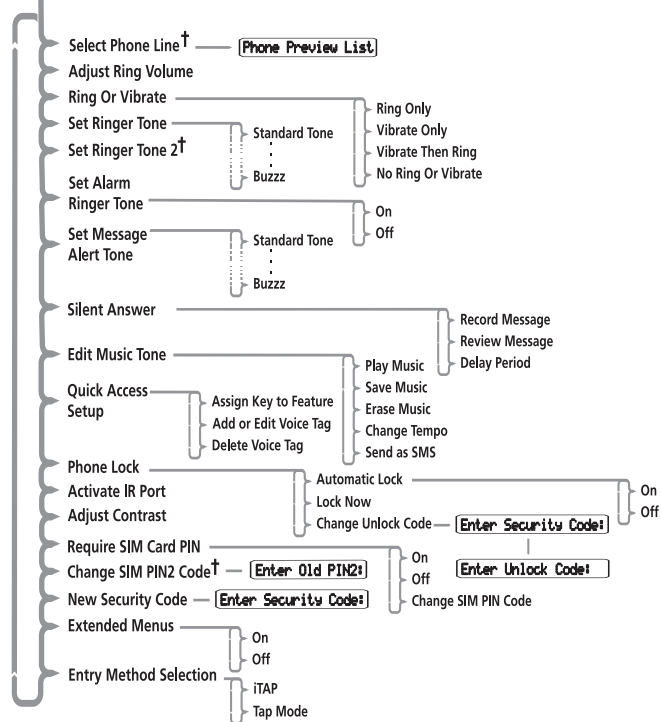

Phone Setup
(Extended Menus - On)

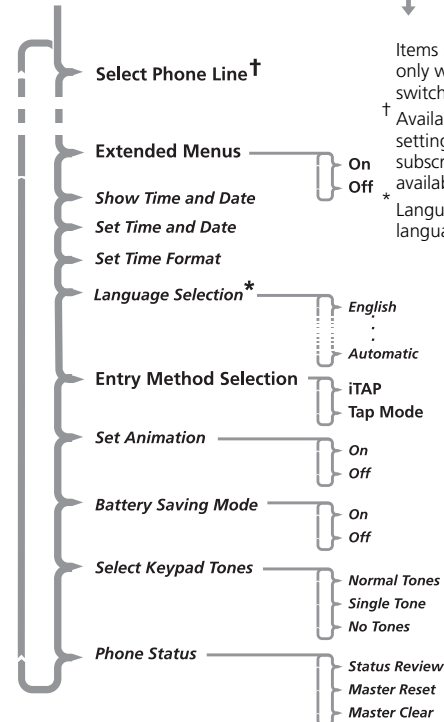

Menu Navigation

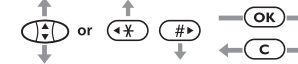

Items shown in *Italics* are available only when **Extended Menus** are switched on.

† Availability depends on the type and settings of the SIM card and/or your subscription to these services where available.

* Languages vary depending upon the language package used.





Select Phone Line

Z Press **(↑)**. Select the Quick Access feature or after the tone, say the Voice Tag name.

This option allows you to switch between Line 1 and Line 2.
I Availability depends on the type and settings of the SIM card, and/or your subscription to this feature.

Adjust Ring Volume

This option is used to set the incoming call ring tone volume. The volume will be displayed as follows:

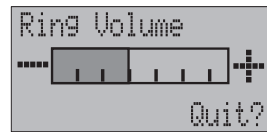
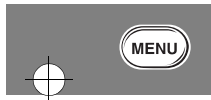

Adjust the volume by pressing the volume buttons on the side of your phone.

Z Press **(↑)** followed by the volume button to either increase or decrease the ringer volume.

OK Ring or Vibrate

Z Press **(↑)**. Select the Quick Access feature or after the tone, say the Voice Tag name.

This option sets the way your phone alerts you to an incoming call. The options are:

- Ring Only - the phone will ring with the tone specified by the Set Ringer Tone option.
- Vibrate Only - the phone will vibrate using VibraCall™.
- Vibrate Then Ring - the phone will vibrate twice and then ring.
- No Ring Or Vibrate - the phone will just display the Call message.

The setting you choose also defines the type of alert for an incoming SMS message and an Internet service alert (except that if you select Vibrate Then Ring, your phone will just vibrate).

OK Set Ringer Tone

This option sets the tone your phone will make when an incoming call is received on Line 1.

Standard Tone

Your phone makes a standard ringing tone.

Music Tones

There are different music tones like Hollywood, Jack n Jill, Buzzzzz, and so on.

When selected, your phone will produce one of these alternative ringer tones.



OK Set Ringer Tone 2

This option sets the tone your phone will make when an incoming call is received on Line 2.

This option will not appear if you do not subscribe to Line 2.

Set Alarm Ringer Tone

This option allows you to turn the alarm ringer tone on or off.

OK Set Message Alert Tone

This option sets the tone your phone makes when it receives an SMS message.

Standard Tone

Your phone makes a standard SMS alert tone.

Music Tones

There are different music tones like Hollywood, Jack n Jill, Buzzzzz, and so on.

When selected, your phone will produce one of these alternative ringer tones.

OK Silent Answer

This feature allows you to answer a call and put the caller on hold automatically for a specified period, giving you the time to excuse yourself to answer the call.

To activate this feature, press Start/Stop Record button (Ⓢ) when there is an incoming call. The call will be accepted and the caller will hear a pre-recorded message or a default music tone asking the caller to wait. The message will be repeated up to a specified delay period. During this time, the phone speaker is inactive and

the caller will not be able to hear any sounds from your surroundings. During the last 5 seconds, the phone will ring to alert you. This alert will not be activated if there is no pre-recorded message.

You can answer the call at any time by opening the flip (models with flip only) or by pressing any key except the power and cancel key. If you do not answer the call within the delay period, the call will be disconnected.

Record Message

This option allows you to record, up to 10 seconds, your own personalised message. Default is a standard music tone.

Review Message

This option plays the message the caller will hear.

Delay Period

This option determines the period the recorded message is played and the period the caller is put on hold before the call is terminated. The valid range is between 10 to 99 seconds. The default value is 30 seconds.

Edit Music

Press (↑). Select the Quick Access feature or after the tone, say the Voice Tag name.

This option allows you to compose your own ringer tone, adjust its tempo (speed) and send it via SMS to another compatible Motorola phone. The tune can contain a maximum of 35 notes, spanning a maximum of 3 octaves. You can also adjust the





duration of each individual note. The screen depicting a tune is as follows:

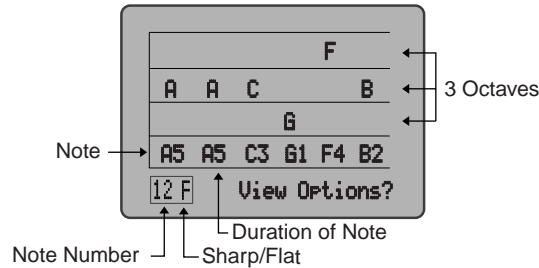

Moving the Cursor

Move the on screen cursor using the **←*** and **#→** keys to shift the key forwards and backwards respectively. Keep pressing **#→** to reach the right-hand edge of the screen. While you are at the beginning of the screen, at the 1st note, press **C** to return to the previous menu. Press and hold **C** to return to the idle screen.

Creating or Changing a Music Note

The music notes are selected using the numeric keypad. The keypad number and musical notes correspond as follows:

Music Notes - Table

Keypad	Musical Note
1	C
2	D
3	E
4	F
5	G
6	A
7	B
0	Rest - similar to a pause. That is, no music will be heard for a short adjustable duration. This is shown on the display as a 'R'.
	Press and hold 0 to fill the notes with 0.
9	Toggles pitch of the note. Two pitches are available: Flat and Sharp .
	To change the pitch of an individual note, keep the cursor between the note and its duration and press 9 . If the cursor is anywhere else, it changes the pitch for all notes.

Changing the Duration of a Note

The duration of the note or rest can last from 1 to 6 with 1 being the shortest duration and 6 the longest. The longest duration corresponds to 1 second. Before changing the duration of the note, move the cursor using the **←*** and **#→** keys and make sure that it is placed between the note and its duration indicator. Enter the duration from 1 to 6.

A5
↑
Position of cursor



Changing the Octave of the Note

Before changing the octave of the note using the volume key on the side of the phone, make sure the cursor is placed on the selected note.

Press the Volume "+" key to shift the current note one octave higher, and press the Volume "-" key to shift it one octave lower.



Play Music

This option will play back the current user composed ringer tone.

Save Music

This option will save the latest user composed ringer tone and override the tune that was previously stored in the phone memory.

Erase Music

This option will erase the latest user composed ringer tone and replace it with the standard pre-programmed musical tune.

Change Tempo

This option will change the tempo of the current user composed ringer tone. The tempo can be adjusted between the values of 1 (slowest) and 4 (fastest). The default tempo setting is 2.

To change the tempo, for example from 2 to 4, erase 2 by pressing **C** and then enter **4**.

Send as SMS

This option will allow you to send the current composed ringer tone stored in your phone to other compatible Motorola phones.

Quick Access Setup

This option allows you to do the following:

- Customise your Quick Access menu.
- Set up and change the Voice Tag allocation for the Quick Access features.

For more information, see *Using Voice Activation*.

OK Phone Lock

Press **↑**. Select the Quick Access feature or after the tone, say the Voice Tag name.

This option is used to set, and change, the unlock code.

The unlock code can be set to protect your phone from unauthorised use. It can be set to automatically lock your phone each time it is switched on.

The unlock code is a four digit number which is set at manufacture to **1234**. This can be changed at any time by using the 'change unlock code' option.

Automatic Lock

This option can be used to automatically lock your phone each time it is switched on. The option has two settings, On or Off.

Lock Now

This option can be used to immediately lock your phone. Once selected, your phone will be unusable until the unlock code is entered.





Change Unlock Code

This option is used to change the unlock code.

After selecting this option, you will be asked to enter the current security code before you can proceed.

You can now enter a four digit code to replace the old code.

By pressing the **(M)** key, you can access this option even when the phone is locked.

Activate IR Port

Press **(↑)**. Select the Quick Access feature or after the tone, say the Voice Tag name.

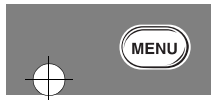

Press **(OK)** to activate the infra-red feature. Activated indicates that the phone is ready for an infra-red connection.

Your phone waits for an infra-red connection for one minute and then automatically de-activates. Before the infra-red feature de-activates, your phone emits an alert tone and displays the Reactivate IR Port prompt. Press **(OK)** to continue.

For additional setup details, see 'Setting up the Infra-Red Feature' in the **About Your Phone, Battery and SIM Card** section of this manual.

Adjust Contrast

Press **(↑)**. Select the Quick Access feature or after the tone, say the Voice Tag name.

This option is used to adjust the screen contrast.

The contrast is displayed as follows:

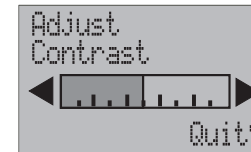

Adjust the contrast by pressing **(↑)** or **(↓)** on the keypad. Pressing **(OK)** or **(C)** on the keypad will end the contrast adjustment.

Require SIM Card PIN

This option is used to set, and change, the PIN code.

The PIN code can be set to protect your SIM card from unauthorised use. If set to **On**, access to your SIM card will be restricted each time it is inserted or the phone is turned on.

The option has two settings, **On** or **Off**.

If the SIM card does not support PIN code disabling, these items will not appear.

Change SIM PIN Code

This option is used to change the SIM card PIN code.

The 'Require SIM Card PIN' option must be set to **On** and you must enter the old PIN code before you can proceed.

You will be asked to enter a new, four to eight digit code to replace the old PIN code. The new PIN code must be entered again as confirmation.



! If the PIN number is entered incorrectly three times in a row, your SIM card will automatically lock-up and the Blocked message will be displayed.

Unlocking Your Phone

If you receive the Blocked message you will need to enter an unblock code and key sequence before you can use the phone.

I The 8 digit PIN unblocking code will have been provided with your SIM card by your Cellular Service Provider.

Enter the following key sequence to unblock your phone:

⬅️⌘ ⬅️⌘ 0➡️ 5 JKL ⬅️⌘ **Unlock Code** **OK**
New PIN Code **OK** **New PIN Code** **OK**

The new PIN code must contain four to eight digits.

! If this operation is performed incorrectly 10 times in a row, your SIM card will become permanently blocked.

Change SIM PIN2 Code

This option is used to change your PIN2 security code.

When you select this option you must enter the old PIN2 security code before you can proceed.

You will be asked to enter a new, four to eight digit code to replace the old PIN2 security code. The new PIN2 security code must be entered again as confirmation.

! If the PIN2 security code is entered incorrectly three times in a row, the Blocked message will be displayed.

When the Blocked message is displayed, you are not allowed access to menu items that require you to enter the PIN2 code, for example 'Setup Fixed Dialling' and 'Call Charge Settings'.

If you receive the Blocked message when you try to enter your PIN2 code, you will need to unblock and change the code using the following key sequence:

⬅️⌘ ⬅️⌘ 0➡️ 5 JKL 2 ABC ⬅️⌘ **Unlock Code** **OK**
New PIN2 Code **OK** **New PIN2 Code** **OK**

I The 8-digit unblocking code will have been provided with your SIM card by your Cellular Service Provider.

! If the PIN2 unblocking operation is performed incorrectly 10 times in a row, your PIN2 code will become permanently blocked.

OK New Security Code

The security code is used to control access to security and other options within the menus.

This option is used to change the security code, which is set at manufacture to 000000.

Once selected, you will be asked to enter the current security code before you can proceed.

You will then be asked to enter a new, six digit code to replace the old security code.

I In order to safeguard your phone, you should change your security code from the factory setting as soon as possible.

OK Extended Menus

⚡ Press and hold **(M)**. Extended Menus will be temporarily activated until you exit the Options menu.

This option is used to switch the extended menus on or off.





If the extended menu option is switched off, you will not be able to access any of the extended features.

The option has two settings, **On** or **Off**.

Show Time and Date

Press **(↑)**. Select the Quick Access feature or after the tone, say the Voice Tag name.

When selected, this option displays the time and date until any key is pressed.

Set Time and Date

This option is used to set the time and date. You will be prompted to Enter Time - the time must be entered in 24-hour format. You will then be prompted to Enter Date*.

Set Time Format

This option is used to set the clock to either 12-hour or 24-hour format.

Language Selection

This option is used to change the language for display messages.

The option has multiple settings. Languages vary depending upon the language package used (for example, Asian, European, and so on).

When you select a language, all further display prompts and help messages will be in the selected language.

Entry Method Selection

This option allows you to select the default entry method for editing text on your phone. Press **(M)** to display each of the available options. Then press **(OK)** to select the entry method you require.

If iTAP does not support the current language set up for your phone, then only Tap is available. Your phone displays Not Available when you press **(M)**.

See *Entering Text on Your Phone*, in **The Phone Book Menu**.

Set Animation

This option allows you to choose between still and animated menu icons.

This option has two settings, **On** or **Off**.

Battery Saving Mode

This option can help you to conserve battery power by activating DTX (Discontinuous Transmission), turning the status indicator off, and deactivating the backlight for incoming Cell Broadcast messages.

The option has two settings, **On** or **Off**.

Select Keypad Tones

This option allows you to change or disable tones you hear when you press a key.

The option has three settings, Normal Tones, Single Tone or No Tones.



Phone Status

Status Review

This option can be used to view the current setting of menu options.

When selected, your phone will display a list of menu items which have been changed from the default setting. Press the **(M)** key to view the next item.

Master Reset

! *This option should be used with caution.*

This option is used to restore certain phone options to their original settings. It only takes effect once the phone has been turned off and back on.

When selected, you will be asked to enter the security code. Once entered, the master reset option will perform the following operations:

- Cancel Automatic Answer, Audible Call Timers, In-Call Display Meter, Battery Save (DTX), Auxiliary Alert, Automatic Handsfree, Automatic Lock, Cell Broadcast and Talk and Fax Mode.
- Return Language Selection and Entry Method Selection to Original.
- Restore Keypad Tones to Normal, Ringer Tones to Standard, SMS Alert Tones to Standard, Volume Level to Medium and Network Search frequency to Medium.
- Restore Extended Menus to their default settings.
- Return the band selection to the default setting.

Master Clear

! *This option should be used with extreme caution, for example it will clear all the Phone Book entries from your phone memory.*

This option is used to restore certain phone options to their original settings.

When selected, you will be asked to enter the security code. Once entered, the master clear option will perform the same operations as 'Master Reset', plus the following operations:

- Clear the Phone Book entries from phone memory (not from SIM memory)
- Clear the Last Calls Made and Last Calls received list
- Clear the Message Editor
- Reset the Resettable Call Timers.
- Erase all recorded VoiceNotes™.
- Erase all recorded Voice Tags.

Master Clear does **not** clear the:

- Fixed Dial list
- My Number(s) list
- Charge Meters
- Received and Outgoing Messages list
- Voicemail number
- SMS Service Centre number
- Lifetime timer.





Network Selection Menu

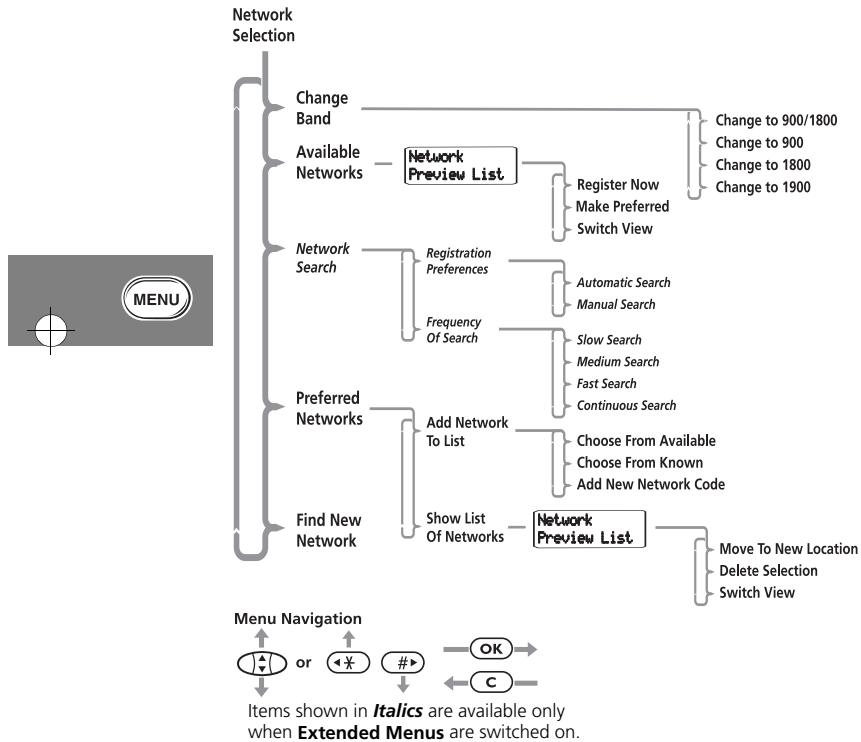

Network Selection

In order for the phone to make and receive phone calls, it must register with one of the available networks. These can be either GSM900, GSM1800 or combined GSM 900/1800, and GSM 1900.

Your phone automatically searches for the last network used. If, for any reason, this network is unavailable, your phone will attempt to register with a new network.

When your phone needs to register with a new network, it will generate a sorted list of networks. The network list is sorted in the following order:

- The Home network.
- Networks from a preferred list.
- A random list of other networks found above a certain signal strength.

Any forbidden networks, stored in the SIM card, will not be included in the sorted list.



Change Band

Press **(↑)**. Select the Quick Access feature or after the tone, say the Voice Tag name.

The country where you purchased your phone determines the default band that it uses. Phones purchased in the USA default to the GSM 1900 band. Phones purchased elsewhere normally default to the GSM 900/1800 band. When you travel abroad, you must remember to change to an appropriate band.

Use this option to change the band of operation for your phone.

The country where you purchased your phone also determines which of the following options are available:

- GSM 900/1800 (referred to as 900/1800)
- GSM 900 (referred to as 900)
- GSM 1800 (referred to as 1800)
- GSM 1900 (referred to as 1900)

When you select Change Band, your phone prompts you to View Options?. Press **(OK)** and then use the **(↓)** key to scroll through the options. Press **(OK)** to select the band you require.

When you select a new band, your phone displays the confirmation message Changed to XXX. and then automatically searches all the available networks.

Your phone then attempts to register with a preferred network within the selected band.

If you re-select the currently selected band, the confirmation message still appears but the band is not changed and the phone does not attempt to register with any other network.

You cannot change bands during a call. If you attempt to change bands during a call, your phone displays Can't Access Network and then returns to the in-call display.

Available Networks

When selected, this option will scan to see which networks are operating in your current location. When the scan is complete, press the **(↓)** key to scroll through the list. When you see a network you wish to register with or store in your preferred list, press the **(OK)** key. You will now enter the 'Register Now' and 'Make Preferred' sub-menu.

Register Now

Once selected, your phone will try to register with the selected network. If the registration fails, your phone will try to register in the normal way.

Make Preferred

Once selected, you will be asked where the selected network is to be located in the preferred list.

Switch View

Allows you to view the details of the selected network. It displays the network name, ID and the network priority. Press **(↓)** to scroll through the networks in the list.





Network Search

These options determine how often your phone tries to register with a network and how the attempt is made.

Registration Preferences

This option determines how the phone tries to register with a network.

The option has two settings, Automatic Search or Manual Search.

Automatic Search Mode

In the automatic mode, the phone will try to register with the first network in the sorted list. If this is successful, your phone will display the network name and then enter the standby mode.

If registration is unsuccessful with one network in the list, your phone will try the next listed network. If your phone fails to register with any of the listed networks, it will start at the beginning of the list after a preset period. The preset period is determined by the 'Frequency Of Search' option.

Manual Search Mode

In the manual mode, the phone will present you with the sorted list of networks. Use the and keys to select one network from the list. Your phone will try to register with the selected network. If this is successful, the phone will display the network name and then enter the standby mode.

If registration is unsuccessful, your phone will present the list again after a preset period. The preset period is determined by the 'Frequency Of Search' option.

Frequency of Search

This option is used to determine how long your phone waits before attempting to re-register after a registration attempt has failed.

The option has the following settings: Slow Search, Medium Search, Fast Search or Continuous Search.

! *Fast and Continuous Search may use up a significant amount of battery power.*

Preferred Networks

Add Network to List

This option enables you to add networks to your preferred list.

When selected, the 'Choose From Available' option will scan to see which networks are operating in your current location. When the scan is complete, press the key to scroll through the list. When you see a network you wish to store in your preferred list, press the key. You will be asked where the selected network is to be located in the preferred list.

The 'Choose From Known' option will, when selected, present you with a preset list of networks. Press the key to scroll through the list. When you see a network you wish to store in your preferred list, press the key. You will be asked where the selected network is to be located in the preferred list.

Select the 'Add New Network Code' option to enter network codes directly. Once entered, you will be asked where the network is to be located in the preferred list.





Show List of Networks

This option is used to display the networks you have stored in your preferred list. In addition, pressing the **OK** key will select the currently displayed entry and enter a move/delete sub-menu.

When 'Move to New Location' is selected you will be asked to enter a new location for the selected network. When selected, 'Delete Selection' will remove the selected network from the preferred list. When selected, *Switch View* displays the network name, ID and the network priority.

Find New Network

 Press **↑**. Select the Quick Access feature or after the tone, say the Voice Tag name.

When selected, the phone will try to register with a network in the normal manner, with one exception. When the registration attempt is made, your current network will be excluded from the list of those available. If the attempt fails, your phone will then try to re-register with the previous network.





Call Meters Menu

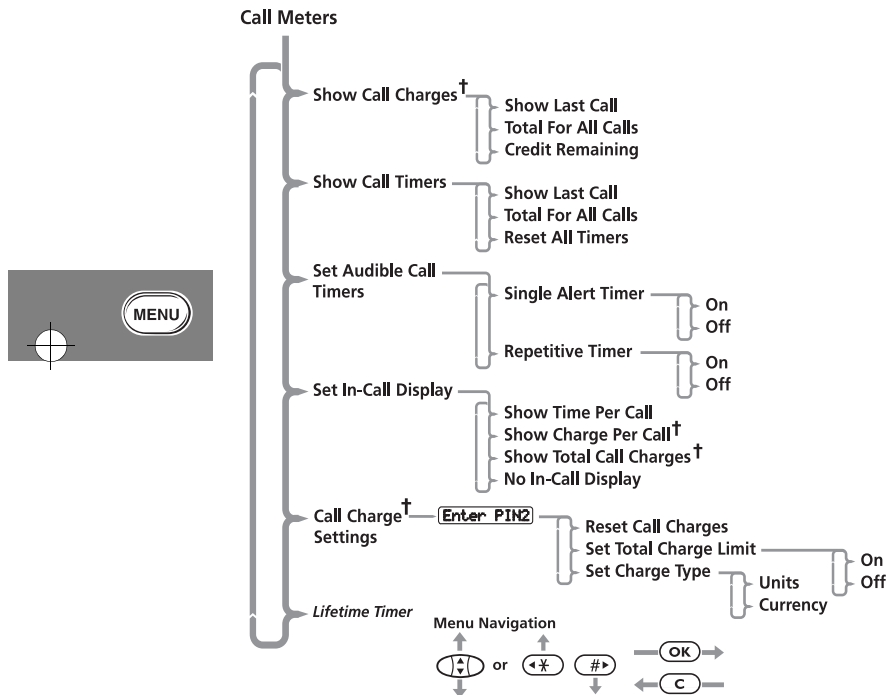

Items shown in *Italics* are available only when **Extended Menus** are switched on.
 † Availability depends on the type and settings of the SIM card and/or your subscription to these services where available.

Call Metering

Your phone has an internal metering system which can be used to provide you with individual and total call times or costs.

Call cost information is only available if you receive the Advice of Charge service. If you do not receive this service, then only time meters are available.

The meter can be displayed during a phone call and audible tones can be generated to indicate the passage of call time.

Your phone can handle values up to 21 digits long, although during calls it can only display the last 12 digits. If the value exceeds 21 digits, then Too Large is displayed.

In addition, you can set a maximum charge limit so that your phone will monitor either the number of units used or the call cost, and then not allow the limit to be exceeded.



Show Call Charges

This feature allows you to display the cost of your calls or the amount of credit remaining. The figures are in phone units or currency depending on the setting of the *Set Charge Type* option.

Show Call Charges is only available if you receive the Advice of Charge service.

Show Last Call

Press . Select the Quick Access feature or after the tone, say the Voice Tag name.

Displays the cost of your last chargeable call.

Total For All Calls

Displays the cost of all your chargeable calls since the charge meters were reset to zero using the 'Reset Call Charges' option.

Credit Remaining

Press . Select the Quick Access feature or after the tone, say the Voice Tag name.

Displays the difference between your total call costs and the limit specified by the 'Set Total Charge Limit' option. If there is no limit, *No Charge Limit Set* will be displayed.

Show Call Timers

This feature allows you to display the duration of your calls and to reset your time meters to zero.

If you receive the Advice of Charge service then all calls are timed. If you do not receive the Advice of Charge service then, depending on the model, either all calls or only outgoing calls are timed.

Show Last Call

Press . Select the Quick Access feature or after the tone, say the Voice Tag name.

Displays the duration of your last call.

Total For All Calls

Displays the duration of all your calls since the time meter was reset to zero using the 'Reset All Timers' option.

Reset All Timers

Sets the resettable time meters to zero. The Lifetime Meter is not resettable.

Set Audible Call Timers

Your phone provides two programmable audible call timers:

- The 'Single Alert Timer' will sound a beep just once during a call, after a preset time has elapsed.
- The 'Repetitive Timer' will sound regular beeps during a call, at preset intervals.

In both cases, the timers will sound their beeps ten seconds before the end of the programmed time.





Set In-Call Display

This feature allows you to specify whether the time or charge meters are displayed during a call. If you do not have the Advice of Charge service, then only the time meter is available.

If a total charge limit has been set, then the in-call display always shows your remaining credit.

Show Time Per Call

This option is used to display the time meter during calls. If you receive the Advice of Charge service, only the chargeable calls will be displayed.

Show Charge Per Call, Show Total Call Charges

These menu items are only available if you receive the Advice of Charge service.

These options are used to display the call charges meter during and after chargeable calls. The meter shows phone units or currency depending on the setting of the 'Set Charge Type' option.

No In-Call Display

This option switches off in-call display of the charge/time meter.

Call Charge Settings

This feature allows you to customise your Advice of Charge settings. You will be prompted to enter your PIN2 security code before you can access the options.

This menu item is only available if you receive the Advice of Charge service.

Reset Call Charges

This option resets your charge meters to zero.

Set Total Charge Limit

This option sets the maximum limit for call charges; once this limit has been reached, the network will refuse any further chargeable calls.

If you switch the charge limit On, you will be prompted to enter a new limit. Enter the amount as either units or currency depending on the setting of the Set Charge Type option. Units must be entered as whole numbers.

When the charge limit is On, you will not be able to make fax or data calls.

Once a limit is set, the in-call display will show the remaining credit. When you reach your last two minutes, the warning message Approaching Charge Limit will be displayed and a warning alert will sound. The sound will be repeated when one minute remains. When the limit is reached the message Charge Limit Reached will be displayed and you will not be able to make any more chargeable calls.

Once the limit is reached the Total Charge Limit will need to be reset or switched off before any chargeable calls can be made.

Select Off to switch off the charge limit.



Set Charge Type

This option defines whether charge information is displayed as either phone units or currency.

Units

Sets the charge type to phone units.

Currency

Sets the charge type to currency. You will be prompted to enter the **Currency** name. Enter a 3-character notation, for example GBP for the UK, DEM for Germany or FFR for France. You will then be prompted to Enter Charge Per unit. Enter the amount and press **OK**.

Lifetime Timer

This option is used to display the total time of all calls made on your phone.

This meter can not be reset, the **Reset All Timers**, **Master Reset** or **Master Clear** options have no effect.





The Calculator Menu

This feature is not available in all countries

About Calculator

This feature allows you to perform simple calculations using the keypad on your phone. The calculator also allows you to set up an exchange rate that you can then use in simple currency conversions.

Accessing the Calculator

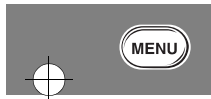

Press **(↑)**. Select the Quick Access feature or after the tone, say the Voice Tag name.

The Calculator feature can be accessed either from the main menu by pressing **(MENU)** and scrolling to the Calculator menu item, or from the Quick Access menu by pressing **(↑)** and scrolling to the Calculator menu item.

Press **(OK)** to confirm selection of the feature and to enter the following screen:

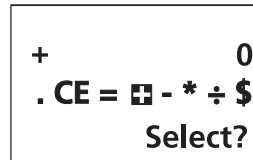

Calculator Screen Elements

The following table defines the elements and their function when using the calculator.

Element	Function
.	Inserts a decimal point.
CE	Clears the entire editor.
=	Performs any operation on the previous two numbers.
+	Adds (+ is highlighted as the default).
-	Subtracts
*	Multiplies
÷	Divides
\$,£,€	Applies a user defined exchange rate to perform a currency conversion.
(←*) (#→)	To scroll left or right for additional operations.
+	Display area for the selected operator symbol (+, -, *, ÷)
0	Display area for numbers and results

Navigating the Calculator Operations

Use the **(←*)** and **(#→)** keys to move around the calculator and highlight a desired calculation symbol or operator. Press **(OK)** to select it.

The + sign is highlighted as the default.

If the right most symbol or operator is selected and you press **(#→)**, the highlight will move to the left most symbol or operator.



If the left most symbol or operator is selected and you press **←X**, the highlight will move to the right most symbol or operator

Using the Calculator

To enter numbers, use the phone's keypad. Each number you enter appears at the end of the line and any previously entered numbers move one position to the left.

The numbers that you enter and the results of any calculations appear in the display area for numbers and results.

The calculator display always starts with a default value of zero

The value you enter and the result of any calculation can have up to 10 digits including the decimal point.

To delete a single number or character from the display, press **C**. To delete your entire entry, select the CE operator.

If you try to perform an invalid calculation or operation, Error appears as the numeric value.

The example that follows illustrates how you use the keypad to perform a simple calculation: 5 + 12 = 17

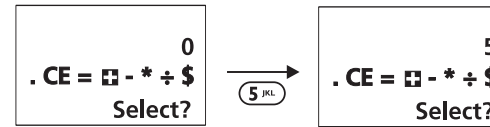

The highlight defaults to the + sign.

5 appears right justified in the display.

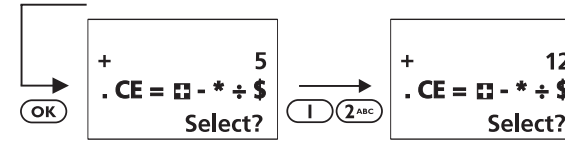

The command + appears left justified in the display.

12 is entered as the second value.

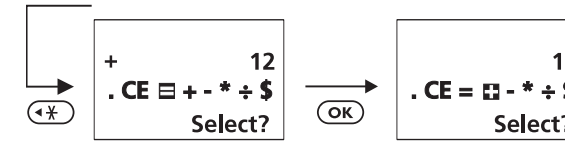

Highlights the equals sign

Displays the result.

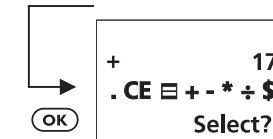

Continues with a new calculation

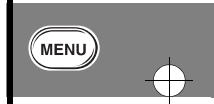



Using the Currency Converter

The currency converter is identified by one of the following currency symbols on the calculator screen:

- £ (for Pounds Sterling)
- \$ (for US Dollars)
- € (for Euros)

Before you can use the currency converter, you must first set up an exchange rate.

Setting the Exchange Rate

To access the Exchange Rate editor, press **MENU** from within the calculator screen.

At the Exchange Rate prompt, enter the exchange rate for the currency that you want to convert to. For example: To enter a rate of **1.4**:

- 1 Press **1** **#>** **4** **GH**.

The **#>** key adds the decimal point

- 2 Press **OK**.

Currency Conversion Example

The following example explains how to convert £5 to US Dollars using a previously stored exchange rate of **1.4**.

- 1 Press **5** **PL**.
- 2 Press **#>** repeatedly to scroll to the currency symbol (\$) and press **OK** to select \$ US Dollars.
- 3 The calculator then takes the entered value of **£5** and multiplies it by the exchange rate of **1.4**. The result is **7**.



Games Menu

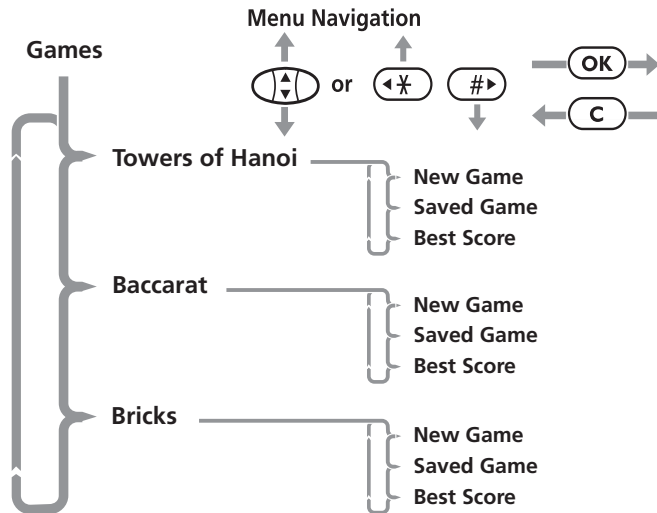

About Games

The Games option allows you to select and play three different games: Towers of Hanoi, Baccarat and Bricks. You can begin each game by selecting either **New Game** or **Saved Game**. You can also view the **Best Score** of a previous game.

New Game

The **New Game** option starts a new session of the game you selected. When you select **New Game** for Towers of Hanoi only, you will be asked to select the level of difficulty for the game.

Saved Game

The **Saved Game** option indicates the last game you saved before you left the Games option. If you saved the last state of the game, you can continue playing at the exact point you left the game, the next time you select the game.

Best Score

You can view the **Best Score** in each type of game and its levels. When you complete a game, the phone records the shortest time of completion. The best score is either the maximum points you earned or the shortest time you have taken in the last game you played.

Keys used in Games

The keys you use to play all the Games are: **4 GHI**, **5 JKL** and **6 MNO**, positioned in the middle row of the keypad. This arrangement enables you to navigate and play easily.

To move left, press **4 GHI**.

To select, press **5 JKL**.

To move right, press **6 MNO**.

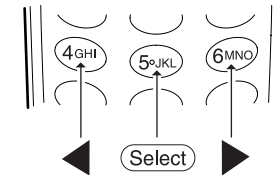



Ending and Saving a Game

While playing a game, you will be interrupted when:

- you receive an incoming call¹
- your phone reminds you of an event
- the battery is discharging, or
- when you press **(C)** to end the game.

When the phone interrupts your play, or you press **(C)** to end the game, the phone will prompt you to select one of the following:

- Press **(C)** (again) to resume playing the game.
- Press **(OK)** to save the game.

Then press **(OK)** (again) to save the state of the game or press **(C)** to return to the Games menu without saving.



Towers of Hanoi

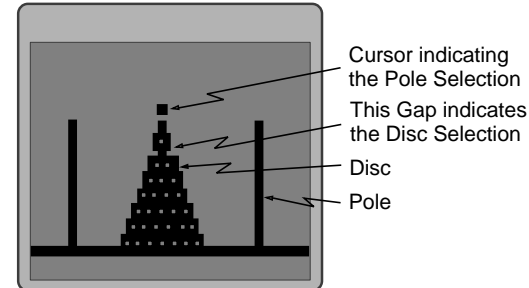

Towers of Hanoi is a single player game requiring skill and logic. When you start a new game the screen displays a number of discs having different widths stacked in an ascending order on a centre pole. There are two empty poles, one positioned on either side of the centre pole. The objective of the game is to move all the discs from the centre pole and stack them on one of the side poles in an ascending order (the smallest at the top of the pole and the largest at the bottom). You can select a level of difficulty between 3 to 7 to indicate the number of discs. The more discs you select, the more difficult the game. When you have moved all the discs from the centre pole to one of the side poles, you end the game.

Once you have selected to play you can choose:

New Game - to start a new game

Saved Game - to continue with last saved game state, or

Best Score - to view the best ever score.

1. Press any key to answer an incoming call. The key you press will not affect your move in the current game.



Game Rules

- You can only move the top disc on the stack.
- You can only move one disc at a time.
- You can not stack a disk on top of one that is smaller.

Playing Towers of Hanoi

When you start a new game, the phone asks you to select the level of difficulty for the new game.

Press any key from **3 DEF** to **7 PQRS** to select the level of the game.

Press **4 GHI** or **6 MNO** to switch between the poles. The cursor positioned above a pole indicates the pole you highlighted and the pole from which you can select discs.

Press **5 JKL** to select a disc on the highlighted pole. (The selected disc moves up a bit and a gap appears below it.)

Press **4 GHI** or **6 MNO** to switch to another pole, then press **5 JKL** to transfer the disc to the pole you highlighted. If the disc you moved is not valid, meaning it is bigger than the disk below, the phone emits a beep. When you have removed all the discs from the centre pole and positioned them on one of the side poles, the phone gives a **Congrats** message and your score for the game.

Baccarat

Baccarat is an exciting card game played at major casinos around the world. The objective of the game is to predict which hand (P - indicating Player, or B - indicating Banker) will get a score closest to 9 or whether it will be a Tie.

Game Rules

- The game starts after you place a bet on either B, P or a Tie; then each player is given 2 cards. Following standard Baccarat rules, a third card may be given to P and/or B.
- The player with a score closest to 9 points wins. If the total of the points on the cards is more than 10, subtract 10 points. The remaining points is the score. For example: $8+8=16$ and it scores as a 6.
- If either B or P wins, all winning bets pay even money (the value of your score). Also, if you win by betting on B, B will receive 5% commission. If the result is a Tie and you bet on a Tie, you will get 8 times the amount you bet.
- All cards carry the points value stated in the card. Ace is one point and tens and face cards (King, Queen and Jack) are zero.

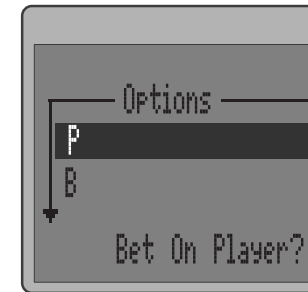



Playing Baccarat

When you start a new game, you are given a balance of 500 points. You will be asked to choose the hand on which you want to place a bet.

Press **(↑/↓)** to scroll up or down to highlight the hand on which you want to place a bet (B, P or Tie).

Press **(5)** to select the hand on which you want to place a bet.

Enter the amount of your bet, then press **(OK)**. The amount must be between 5 and 500 points (up to a maximum of your current balance).

You will be prompted to Deal? Press **(OK)** to deal.

Before you deal, you can bet on more than one hand. Press **(C)** and reselect the hand and the amount of the bet. The sets of cards for both B and P are displayed and flash for some time.

The result of the bet is shown as below:

beeps, followed by a screen message *Conrats* and amounts *Won:*, *Lost:* and *Balance:*

followed by a screen message *Bad Luck* and amounts *Won:*, *Lost:* and *Balance:*.

The Best Score in this game is the highest balance amount ever reached.

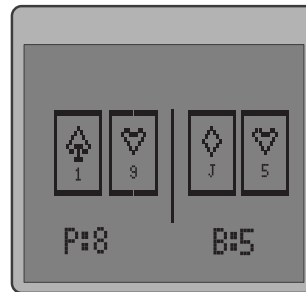

If you want to end the game press **(C)** at the first betting screen or at the result screen. When you save a game, your current balance also gets saved.

Bricks

Bricks is a single player game of fun. There are bricks at the top of the screen and a paddle at the bottom. A ball moves between the bricks and the paddle. The objective of the game is keep the ball in motion (so it does not hit the bottom boundary of the screen) and hit the maximum number of bricks. To do this, you must hit the ball with the paddle to make the ball bounce upwards at an angle so it hits the bricks. The angle that the ball takes is determined by the angle it hits the paddle. When the ball hits a brick, the brick disappears and the score of the game increases by the number of points assigned to the brick you hit. The ball may hit more than one brick at a time. All the bricks in the 5th (top) row have 30 points, 4th row 25 points, 3rd row 20 points, 2nd row 15 points, and 1st (bottom) row 10 points. The ball bounces when it hits any of the surfaces in the screen, except for the bottom boundary.

For best viewing set the display contrast to moderate.

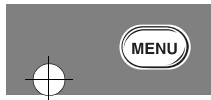



Game Rules

- You must ensure that the ball does not hit the bottom boundary. If it does, the game will end.
- To move the paddle to the left, press **(4 GHI)**.
- To move the paddle to the right, press **(6 MNO)**.
- When the ball hits the left or the right boundaries it will deflect in the opposite direction.

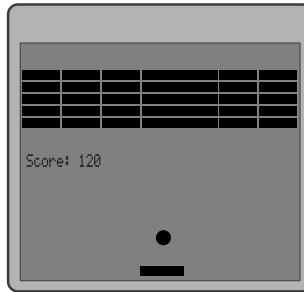

want to start the game again, by the three options *New Game*, *Saved Game*, or *Best Score*.

To end a game in progress press **(C)**.

You can save an unfinished game with the score you achieved, if you want to continue later on.

Playing Bricks

Once you have selected the Bricks game you can choose:

New Game - to start a new game

Saved Game - to continue with last saved game state, or

Best Score - view the best ever score.

When you start a new game, the paddle appears in the middle of the screen on the lower boundary, with the ball slightly above the paddle.

To ensure that the ball doesn't hit the bottom boundary, you must hit it with the paddle.

Press **(4 GHI)** to move the paddle left and **(6 MNO)** to move the paddle right while the game is in progress. The game ends when the ball hits the bottom boundary or when you have hit all the bricks.

When the game ends, the screen flashes three times and displays your score. After your score appears you are prompted, if you





Accessory Setup Menu

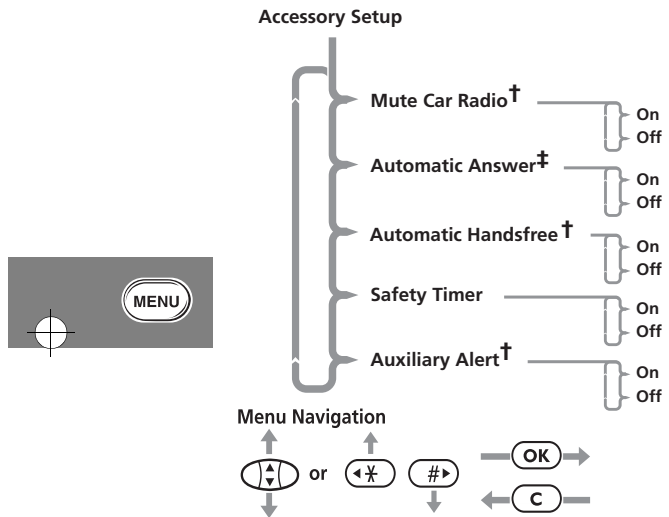

- † Availability depends on the type of car kit installed.
- ‡ Only this option will be displayed when the headset accessory is attached.

You will only be able to access this menu when your phone is mounted in a car kit or when a headset accessory is attached. Car kits can provide charging facilities and some provide connection to an external antenna for better reception.

Your phone can also be linked to external microphones and speakers for hands free operation, and provides several options to complement the use of car kits.

OK Mute Car Radio

This option can be used to mute your car radio when you make, or receive, a call when your phone is attached to the car kit. It must be enabled by your local dealer.

This option has two settings, **On** or **Off**.

This option will have no effect if your car radio does not have a mute feature, or if the car kit installation does not support this option.

Automatic Answer

This option allows your phone to automatically answer an incoming call after two rings.

This option has two settings, **On** or **Off**.

If this option is **On**, we recommend that the 'Ring or Vibrate' option be set to **Ring Only**.

Automatic Handsfree

This option is used in conjunction with the 'Automatic Answer' option and a car kit, to transfer call conversation to external microphones and speakers. It is available only with selected car kits. Contact your *Motorola* representative for further details.

This option has two settings, **On** or **Off**.



Safety Timer

This option can be used to keep the phone on for a set period after the vehicle ignition has been turned off. This prevents the vehicle's battery from becoming drained and saves you from having to re-enter PIN and Unlock codes after every short stop.

As standard the 'Safety Timer' is set to 60 minutes. Once selected, this option can be adjusted to any value between zero and 999 minutes. When set to zero, this option is effectively switched off.

Auxiliary Alert

This option allows your phone to alert you of an incoming call by flashing your vehicle lights, or by sounding the horn. It must be enabled by your local dealer.

 *Some local regulations prevent the use of this option and, accordingly, this option may not be present on your phone.*





Using the Quick Access Menu

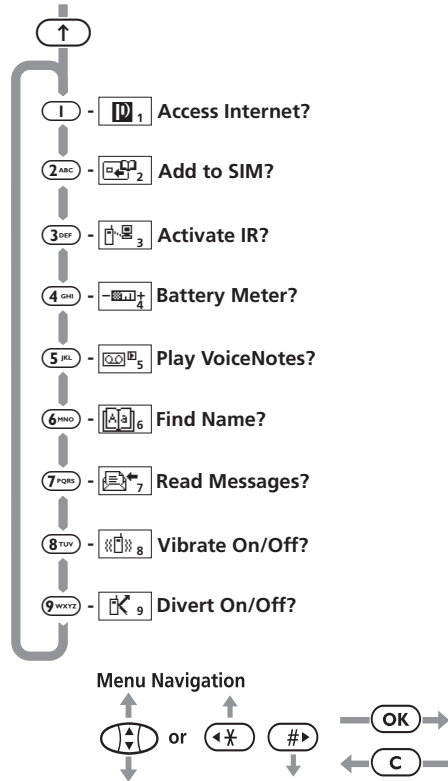

The menu shown above represents the default setting supplied with your phone.

Although the features in your phone are available through easy access menus, some of the most commonly used features are also available in the Quick Access menu. Each feature in the menu is allocated a number from 1 to 9.

To use a Quick Access feature, you can use any of the following methods:

- Press the quick access key (↑) and say the Voice Tag name after the tone. For best results, use in an area with minimal wind or background noise. See *Using Voice Activation*.
- Press (↑) followed by the number of the feature.
- Press (↑). Use (↓) to highlight the appropriate menu option and then press (OK) to select it.

You can change the features, and the positions of the features, available in the Quick Access menu - see *Customising the Quick Access Menu*.

Each Quick Access feature is represented by an icon as well as the feature name. The currently selected icon is shown with a dark background.



Access Internet?

This is a network and subscription dependent feature. Contact your service provider for details about the mobile internet services based on the WAP (Wireless Application Protocol) technology that they provide.

Use this option to start your mobile internet session. This option connects to the Phone.com website. See *Access Internet* for more information.

 **Add to SIM?**

You will be prompted to enter a phone number and then a name.

 *If you already had a number displayed, it will automatically be re-displayed when you select this feature.*

The number will be stored in the next available SIM card location. See *Add Entry*, for more information.

 **Activate IR?**

Activates the infra-red lens on the top of your phone. This allows you to communicate with any external device that also supports infra-red communications.

See *Activate IR Port*, for more information.

 **Battery Meter?**

A bar graph indicating the approximate battery charge level will be displayed. The more bars displayed, the greater the charge level.

See *Show Battery Meter*, for more information.

 **Play VoiceNotes?**

Plays the recorded VoiceNotes™. See *Using VoiceNotes™*, for more information.

 **Find Name?**

You will be prompted to Enter Name. Enter the first three characters of the name and press **OK**. The first matching entry in the Phone Book will be displayed. Press **OK** to call the number.

 **Read Messages?**

Your newest message will be displayed; you can then read, delete and edit messages as normal. See 'Received Messages' for more information.

 **Vibrate On/Off?**

VibraCall™ will be switched either on or off depending on the current setting. If VibraCall™ is switched on, the 'Ring or Vibrate' setting changes to Vibrate Only. If VibraCall is switched off, the 'Ring or Vibrate' setting changes to Ring Only. See *Ring or Vibrate* for more information.

 **Divert On/Off?**

Unconditional voice call diversion will be switched either on or off depending on the current setting. This will allow Fax and Data diversion to remain enabled independent of the Voice Call Diversion setting.

 *You must have defined a diversion number using the 'Divert All Voice Calls' option in the Call Diverting menu in order to use this feature.*

 *You cannot switch call diverting on or off if you are outside network coverage.*

 **Find Location?**

You will be prompted to Enter Location. Enter the location number and press **OK**. The first matching entry in the Phone Book will be displayed. Press **OK** to call the number.

Add to Phone?

You will be prompted to enter a phone number and then a name.

 *If you already had a number displayed, it will automatically be re-displayed when you select this feature.*

The number will be stored in the next available phone memory location. See 'Add Entry', for more information.

Call Voicemail?

Your phone will make a call to your voicemail number.

 *You must have defined a Voicemail number in order to use this feature.*

See 'Call Voicemail' for more information.

Mute Phone?

Temporarily turns the microphone off during a phone call. Reselect this option to resume your conversation.

Lock Now?

Immediately locks your phone, you will not be able to use your phone until the unlock code is entered. See *Phone Lock* for more information.

Adjust Ring?

This option is used to display and to set the incoming call ring tone volume.

Switch Memory?

Switches one-touch dialling between the phone and SIM memories depending on the current setting.

Outgoing SMS?

Your newest message will be displayed; you can then read, send, delete and edit messages as normal. See *Outgoing Messages*, for more information.

Message Editor?

The last message that was edited will be displayed. Press and hold **C** to clear the message and start a new one, or modify the message displayed. See *How to Create and Edit SMS Messages*, for more information.

Games - Towers of Hanoi?

Games - Baccarat?, Games - Bricks?

Allows you to enter one of the above 3 games. See *Games Menu*, for more information.

Date Book?

Allows you to put your schedule into your phone.

Answering Machine?¹

Lists the unread voice messages.

Missed Calls?

Answered Calls?, Made Calls

Allows you to access and select the list of Missed, Answered and Made calls respectively. See 'Missed Calls', 'Answered Calls' and 'Made Calls' for more information.

¹ This feature is not available in all countries.

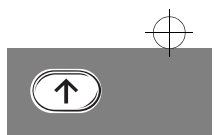



Call Charge?

Displays the cost of your last chargeable call. See 'Show Call Charges', for more information.



Call Timer?

Displays the duration of your last chargeable call. See *Show Call Timers*, for more information.



Switch Line 1/2?

 *Availability depends on the type and settings of the SIM card, and/ or your subscription to this feature.*

Allows you to switch between Line 1 and Line 2.



Restrict My ID?

Your phone number will not be sent with the next attempted call; after this your phone number will be sent until you reselect this option.



Show Services?

 *Availability depends on the type and settings of the SIM card, and/ or your subscription to this feature.*

Displays a list of phone numbers and services provided by your Cellular Service Provider.



Show Time/Date?

Displays the current time and date.



Show Credit?

Allows you to quickly display the Credit Remaining.

 *This will only show the credit remaining if you receive the Advice of Charge service.*



Find New Network?

Allows you to quickly search for a new network.



Adjust Contrast?

Allows you to adjust the screen contrast.



My Motorola?

Use this option to start your mobile internet session and access the *MyMotorola.com*¹ web site. See **Access Internet** for more information.



Calculator?

 *This feature is not available in all countries*

Use this option to display the calculator. See **Using the Calculator** for more information.



Change Band?

Use this option to change the band of operation for your phone. See *Network Selection Menu*, for more information.



Edit Music?

Use this option to compose your own ringer tone.

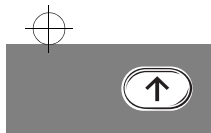



¹ Availability depends on the type and settings of the SIM card and/or your subscription to these services where available.

Customising the Quick Access Menu

You can change the features in the Quick Access menu to suit your personal preferences.

To customise the menu, you can use either the Quick Access Setup menu (See *Using Voice Activation*) or you can do the following:

- 1 Press  and scroll to the menu item you wish to change.
- 2 Press and hold  to access the list of features available. The currently selected feature will be displayed.
- 3 Scroll through the list until you find the feature you wish to store in the Quick Access menu; press .
- 4 Completed will be displayed to confirm that the feature has been stored.

The items in the Quick Access list will appear in the following order:

- Find by Name
- Find by Location
- Add Entry to Phone
- Add Entry to SIM
- Call Voicemail
- Battery Meter
- Phone Lock Now
- Phone Mute on or off
- Ring Volume
- VibraCall On or Off
- Switch Memory

- Read Messages
- Outgoing Messages
- Message Editor
- Missed Calls
- Last Call Charge
- Last Call Timer
- Show Time and Date
- Credit Remaining
- Restrict My ID
- Show Services¹
- Find New Network
- Switch Lines 1/2¹
- Change Band
- Play VoiceNotes™
- Divert Voice Call
- Adjust Contrast
- Activate IR Port
- Access Internet
- My Motorola
- Edit Music Tone
- Date Book

¹ Availability depends on the type and settings of the SIM card and/or your subscription to these services where available.

- Answering Machine¹
- Games Bricks
- Games Baccarat
- Games Towers of Hanoi
- Answered Calls
- Made Calls
- Calculator¹

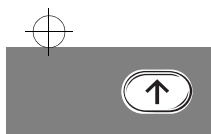

¹ This feature is not available in all countries.

English

112 Using the Quick Access Menu

Accessories

The following accessories have been designed to work with your phone. Additional accessories may be available and are packaged separately. Please refer to your local service provider or retail outlet for more information.

Desktop Charger

The Desktop Charger allows you to charge a battery fitted in a phone and a spare battery at the same time. The charging status for each battery is indicated by LEDs at the front of the charger.

 *The Desktop Charger must be used with the Power Adapter.*

Power Adapter

The Power Adapter (charger) connects to the Desktop Charger or directly to the phone. When connected directly to the phone, it charges the battery and also provides dead battery operation.

The Power Adapter requires an appropriate Adapter Plug.

UK Adapter Plug

The UK Adapter Plug connects the Power Adapter to a UK-style mains power outlet.

European Adapter Plug

The European Adapter Plug connects the Power Adapter to a Continental European-style mains power outlet.

AustINZ Adapter Plug

The Australia/New Zealand Adapter Plug connects the power adapter to a Australian/New Zealand mains power outlet.

US Adapter Plug

The US Adapter Plug connects the Power Adapter to a US mains power outlet. This plug can also be used in the Philippines.

Indian Adapter Plug

The Indian Adapter Plug connects the power adapter to an Indian mains power outlet. This plug can also be used in Pakistan and Bangladesh.

Cigarette Lighter Adapter

The Cigarette Lighter Adapter connects to your phone and allows you to charge your phone's battery while driving. When the phone is in use, the adapter overrides the battery therefore preserving battery life. The adapter also provides dead battery operation.

Smart CELlect™ 2000

Allows you to browse the Internet, email, fax, and send SMS using just your phone and a cable with a RS232 connection.

TrueSync® Software

Allows you to synchronise the phone book and send SMS.

Personal Handsfree System

A personal headset for convenient handsfree operation.

Carry Cases

Protects the surface of the phone. Carry cases can be used with the belt clip.



Belt Clip

The Belt Clip holds the phone while being worn on your belt.

 *To use the belt clip, you must remove the rubber plug from the rear housing.*

Easy Install Handsfree Car Kit

Includes a battery charger and speaker for handsfree operation in the car. There is no installation needed.

Professional Install Handsfree Car Kit

The Standard Vehicle Handsfree System includes a battery charger, phone holder, speaker and microphone.

 *These accessories require professional installation.*



 **A tri-band antenna should be specified when installing a Vehicle Handsfree System for use with tri-band phones.**



What to do if...

You can't switch your phone on	<i>Check the battery.</i> Is it charged, properly fitted and are the contacts clean and dry? See 'Important Battery Information'.
You can't make calls	<p><i>Check the signal strength meter in the display.</i> If the signal is weak, move to an open space or, if you are in a building, move closer to a window.</p> <p><i>Check the Network Selection settings.</i> Try Manual Selection, or try another network. See 'Network Search'.</p> <p><i>Check your Operator coverage map.</i></p> <p><i>Is Restricted displayed?</i> Check the Call Barring and Fixed Dialling settings.</p> <p><i>Has the call charge limit been reached?</i> Use your PIN2 code to reset the limit or contact your Service Provider. See 'Set Total Charge Limit'.</p> <p><i>Has a new SIM card been inserted?</i> Check that no new restrictions have been imposed.</p>
You can't receive calls	<p><i>Check the signal strength meter in the display.</i> If the signal is weak, move to an open space or, if you are in a building, move closer to a window.</p> <p><i>Check the Call Diversion and Call Barring settings.</i></p> <p><i>Check the Ringer and VibrateCall™ settings.</i> If both are off, there is no audible alert. See 'Ring or Vibrate'.</p>
Your phone won't unlock	<p><i>Have you inserted a new SIM card?</i> Enter the new PIN code. See 'Entering Your SIM Card PIN Code'.</p> <p><i>Do you have a replacement phone?</i> Enter the default phone unlock code - 1234.</p> <p><i>Have you forgotten the unlock code?</i> Press (M) to change the unlock code (you will need your security code).</p>
Your PIN is blocked	<i>Enter the PIN unblocking code supplied with your SIM card (see 'Unlocking Your Phone').</i>
Your PIN2 is blocked	<i>Enter the PIN2 unblocking code supplied with your SIM card (see 'Change SIM PIN2 Code').</i>
Your SIM card won't work	<p><i>Is the card inserted the right way round?</i> See 'SIM Card Insertion/Removal'.</p> <p><i>Is the gold chip visibly damaged or scratched?</i> Return the card to your Service Provider.</p> <p><i>Check the SIM contacts.</i> If they are dirty, clean them with an antistatic cloth.</p>



The battery won't charge	<p><i>Check the charger.</i> Is it properly connected? Are its contacts clean and dry? See 'Your Battery'.</p> <p><i>Check the battery contacts.</i> Are they clean and dry?</p> <p><i>Check the battery temperature.</i> If it is warm, let it cool before recharging.</p> <p><i>Is it an old battery?</i> Battery performance will decline after several years use. Replace the battery.</p> <p><i>Are you using a Motorola original battery?</i> Your charging system may not be able to communicate with your battery. See 'Your Battery'.</p>
The battery icon and meter are missing	<p><i>Are you using a Motorola original battery?</i> Your charging system may not be able to communicate with your battery. See 'Your Battery'.</p>
The battery drains faster than normal	<p><i>Are you in an area of variable coverage?</i> This uses extra battery power.</p> <p><i>Is it a new battery?</i> A new battery will need two to three charge/discharge cycles to attain normal performance. See 'Charging a New Battery'.</p> <p><i>Is it an old battery?</i> Battery performance will decline after several years use. Replace the battery.</p> <p><i>Is it a battery that hasn't been completely discharged?</i> Allow the battery to fully discharge (until the phone turns itself off) and then charge the battery overnight.</p> <p><i>Check that the Frequency Of Search feature in the Network Selection menu has not been set to Fast Search or Continuous Search.</i> See 'Network Search'.</p> <p><i>Check that the Battery Saving Mode feature has not been set to Off.</i></p> <p><i>Are you using your phone in extreme temperatures?</i> At extreme hot or cold temperatures, battery performance is significantly reduced.</p>
You can't cancel Call Diverting or Call Barring	<p><i>Wait until you are in an area with good network coverage and try again.</i></p>
The  symbol is flashing	<p><i>There is not enough memory available to store another SMS message.</i> Use the Messages menu to delete one or more existing messages.</p>
I can't make international calls	<p><i>Some Service Providers automatically bar the ability to make international calls.</i> Contact your Service Provider.</p> <p><i>Have you included the relevant codes?</i> Press and hold the  key to display the international dialling prefix (+) and then enter the appropriate country code followed by the phone number.</p>



Index

A

- Access Internet46
- Accessories 113
- Accessory setup menu 104
- Activate IR Port
 - Setting up 20
 - Using 84
- Add entry
 - To phone memory 58, 109
 - To SIM card memory 58, 108
- Adjust Contrast 84, 110
- Adjust ring volume 80
- Alert tones 81
- Answered Calls 60
- Answering Machine 76
- Assign Key to Feature 42
- Automatic answer 104
- Automatic Handsfree 104
- Automatic lock 83
- Automatic redial 28
- Auxiliary alert 105
- Available networks 89

B

- Bar incoming calls 70
- Bar outgoing calls 69

Batteries

- Charging 21
 - Desktop charging 23
 - Fitting 22
 - Low battery warning 21
 - Maintaining 21
 - Removing 22
- Battery charge indicator 19
- Battery meter 65, 108
- Battery saving mode 86
- Blocked message 27, 85
- Bookmark List 50
- Buttons
 - Smart button 17
 - Start/Stop Record 18
 - Volume 18

C

- Calculator Menu 96
- Call charge settings 94
- Call diverting 108
- Call holding 33
- Call metering 92
- Call meters menu 92
- Call related features menu 65
- Call timers 93
- Call Transfer 36
- Call Voicemail 73
- Call waiting 33
- Calling a number 28
- Cancel all diverting 68, 108

Capacity

- Checking battery capacity 65
- Checking Phone Book capacity 59
- Cell broadcast 77
 - Battery saving mode 86
 - Channel List 77
 - Messages 72
- Change band 89, 110
 - From the default (1900) 89, 110
 - From the default (900/1800) ... 89, 110
- Change bar password 70
- Change SIM PIN2 code 85
- Change unlock code 84
- Characters 53
- Charge meters
 - Resetting 94
- Check capacity (of the Phone Book) 59
- Communications
 - Infra-Red 20, 84, 108
 - RS-232 Serial Data 20
- Conference Call 33
 - End Active And Held 33
 - Hold Call 32
 - Make a New Call 32
 - Reconnect 33
 - Reconnect Held Call 33
 - Restrict My Number 32
 - Split Call 33
 - Switch Calls 33



Contrast		E		H	
Adjust Contrast	84, 110	Earpiece connector	20	Handsfree On/Off	32
adjusting	110	Edit Music Tone	81	Headset	
Copy between SIM and Phone	59	Editing messages	73	Making and receiving calls	17
Creating or Changing a Music Note	82	Emergency calls	30	Hold Call	32
Currency Converter	98	Ending a phone call	31		
D		Entering text	53	I	
Date Book	63	Entry Method Selection	54, 86	In use symbol	19
Delete		Erase Music	83	Infra-Red	20, 84, 108
Last ten calls	61	Erase name and number	58	Initiating Transfer Call	36
Message	73, 75	Extended menus	5, 85	International phone calls	29
Phone book entries	58	F		Internet	
Desktop charging of your battery	23	Fault finding	115	Accessing	46
Detailed diverting	68	Find entry by location	57, 108	Internet service alerts	49
Dialling phone book numbers	29	Find entry by name	57, 108	iTAP Mode	54
Display	18	Find new network	91	Dynamic Dictionary	55
Adjusting the contrast	84, 110	Fitting your battery	22	Locking a word	55
Display characters	53	Fixed dialling	61	K	
Displaying your own phone number	61	Calling numbers	61	Key Answer Only	70
Divert		Setting	62		
Cancelling	68	Flip	17		
Fax calls	68	G			
Diverting Scheduled	67	Games Menu	99		
DTX	86	Baccarat	101		
Dynamic Dictionary	55	Bricks	102		
		Towers of Hanoi	100		



L

Language selection86
 Last Calls Received
 Add to Phone Memory60
 Add to SIM Card Memory60
 Last ten calls 59, 109
 Lifetime timer95
 Lock now 83, 109
 Locking the keypad27
 Low battery warning21

M

Made Calls60
 Making a phone call28
 Master clear87
 Master reset87
 Menu
 Access Internet46

Menus

Accessory setup menu 104
 Call Diverting menu66
 Call meters menu92
 Call related features menu65
 Extended menu5
 Messages menu71
 Network selection menu88
 Options menu45
 Personalised menus5
 Phone Book menu51
 Phone setup menu79
 Quick Access menu 107
 Send Messages menu75
 Short menu5
 Message editor 76, 109
 Message settings77
Messages
 Call holding/call waiting messages ...34
 Cell broadcast messages72
 Creating and editing73
 Reading SMS messages72
 Sending SMS messages75
 Messages menu71
 Missed Calls60

Mobile Internet

Display features46
 Editing Text49
 Ending the session 50
 Icons and messages47
 Internet service alerts49
 Making and Receiving Calls49
 Setting Up47
 Soft Keys47
 Starting the session49
 Summary of keys 50
 Moving the Cursor82
Music Tone
 Edit81
Music Tones
 Set Ringer Tone80
 My phone number(s)61

N

Names
 Entering53
 Network search90
 Network selection menu88
Networks
 Automatic search90
 Change band 89, 110
 Finding new networks91
 Manual search90
 New security code85
 Numeric Mode56



O

One-touch dial setting 62
 One-touch dialling 29, 109
 Options menu 45
 Outgoing messages 75, 109

P

Pauses
 Inserting into phone numbers 29
 Personal numbers 56
 Personalised menu 5
 Phone book
 Call number 58
 Capacity 52
 Deleting/erasing entries 58
 Dialling phone book numbers 29
 Modify name or number 58
 Preventing access to 59
 Storing numbers - see *Add Entry* 58
 Phone calls
 Automatic redial 28
 Dialling phone book numbers 29
 Emergency calls 30
 Ending 31
 International 29
 Making 28
 One-touch dialling 29
 Receiving 30
 Phone setup menu 79
 Phone status 87



PIN code

 Entering 27
 Setting and changing 84
 PIN2 code 85
 Play Music 83
 Postscripting 52
 Prevent access (to Phone Book) 59

Q

Quick Access features
 Assign key 42
 Setup 41
 Quick access menu 107
 Customising 111
 Quick Access Setup 41

R

Reading SMS messages 72
 Received messages 73
 Receiving a phone call 30
 Recording VoiceNotes 37, 76
 Redialling the last number called 28
 Removing your battery 22
 Require SIM card PIN 84
 Restrict My Number 32
 Restrict my phone number 66, 110
 Retrieve Numbers 74
 Return call 74
 Ring or vibrate 80
 Ring tones 80

S

Safety timer 105
 Scheduled Diverting 67
 Screen
 adjusting the contrast 110
 Security code
 Changing 85
 Select Phone Line 80
 Send as SMS 83
 Sending SMS messages 75
 Service centre 77
 Set Alarm Ringer Tone 81
 Set Animation 86
 Set in-call display 94
 Set Message Alert Tone 81
 Set Reminder Period 63
 Set Reminder Tone 64
 Set Ringer Tone 80
 Set Ringer Tone 2 81
 Set Time and Date 86
 Set Time Format 86
 Setup fixed dialling 62
 Short menu 5
 Short message service symbol 19
 Show battery meter 65, 108
 Show call charges 93, 110
 Show call timers 93, 110
 Show Services 59
 Show Time and Date 86
 Signal strength symbol 18
 Silent Answer 81

SIM card
 Insertion/removal26
 PIN code27, 84
 PIN2 code85
 Smart button17
 SMS Message
 Received Ringer Tone74, 75
 SMS messages72
 Special keys17
 Split Call33
 Start/Stop Record button18
 Status indicator20
 Battery saving mode86
 Status review87
 Switch Calls33
 Switch View60, 73, 89
 Symbols18

T
 Talk and fax68
 Tap Mode56
 Text Entry Method
 iTAP Mode54
 Numeric Mode56
 Selecting54, 86
 Tap Mode56
 Timers93
 Tones
 Setting alert tones81
 Setting ringer tones80
 Transfer Call36
 Transmission rate68

Troubleshooting115
 Turn Mute On or Off33

U
 Unanswered Call Notification31
 Unblocking your phone85
 Unconditional call diversion108
 Unlock code
 Setting and changing83
 Using the Calculator97

V
 VibraCall80, 108
 Voice Activation
 Phone Book entries40
 Quick Access features43
 Voice Dialling41, 56
 Voice Features37
 Voice Activation39
 VoiceNotes37
 Voice Tag (Phone Book)
 Adding or editing when entry
 exists40
 Adding when entry is new39
 Deleting40
 Voice Tag (Quick Access)
 Adding or editing42
 Deleting42
 Voicemail
 Number77
 VoiceNotes37, 76
 Recording18, 37

Volume
 Adjusting the earpiece and keypad
 volume18
 Adjusting the ringer volume80
 Automatic volume control18
 Button18

W
 What to do if...115







