









Special Keys

-  Press to turn phone on and off.
-  Press to see more information on the current operation.
-  Press to accept call, setting, option,...
-  Press to switch privacy mute on and off.
-  Press to access the Phone Book menu.
-  Press to access the Messages menu.
-  Press to access the Options menu.
-  Press to reject call, setting, option,...

Making a Call

Enter **Phone No.** .





Receiving a Call

Press  or open the flip.

Ending a Call

Press  or close the flip.



Making an Emergency Call

Enter    . The call will be directed to a central emergency operator.

Adjusting the Ringer Volume

Press the volume buttons on the right hand side of the phone with the flip closed.

Calling the Last Number Dialed

- 1 Press the  key. The last number dialed will be shown in the display.
- 2 Press  to call the number.







One Touch Dialling

Press and hold the appropriate digit key  to .

Dialling Phone Book Numbers

Press  **Location**  .

Storing Numbers in the Phone Book

- 1 Press and hold  to access the Phone Book.
- 2 Press  to choose whether to store the number in the phone memory or the SIM card memory. Press .
- 3 Enter **Phone No.**  (remember to include the full area code).
- 4 Enter the name followed by  and then the location number followed by .
- 5 The phone will confirm the location of the stored number, for example: **Stored 123**.

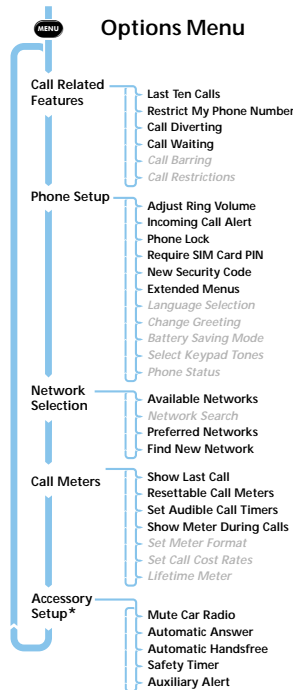
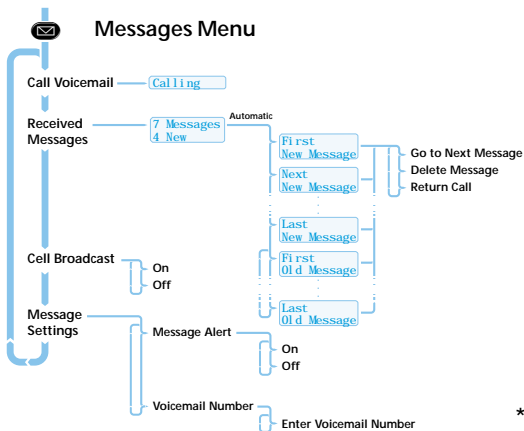
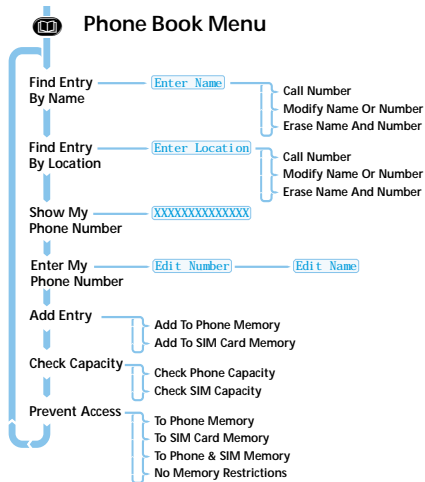

Menu Navigation



Items shown in *italics* are available only when **Extended Menus** are enabled.

* The **Accessory Setup** section is available only when a car kit is fitted.

Introduction



Congratulations on your purchase of a cellular telephone from *Motorola*, the world leader in cellular technology.

All Motorola cellular telephones are manufactured to exacting specifications and world-class quality standards, and are designed to withstand the harshest environmental conditions. Our commitment to *Total Customer Satisfaction* and over sixty five years of experience in personal communications mean you can depend upon the quality of this Motorola product.

This cellular telephone incorporates **Personality™**. Unique to Motorola, **Personality™** removes the complexity of cellular communications by guiding you through the features and presenting you with simple choices every step of the way. **Personality™** also allows you to personalise the way you use your phone - for example, different ringer tones, a phone book and network selection preferences - all presented with clarity and simplicity. In this manual, each of the **Personality™** features is identified with an **OK** symbol to indicate that it is customisable to meet your requirements.

This cellular telephone has been designed for use with the worldwide GSM (Global System for Mobile communications) network. By using digital communications methods, your phone provides a number of advantages over traditional cellular systems:

- Superior speech quality is attained without the usual background noises and interference.
- Your conversation may be encrypted for security. Conversations cannot be eavesdropped using scanning equipment when the signal is encrypted.
- You are not restricted to use within one country.

Your subscriber number is not contained within the phone as with other systems. Instead, a 'Smart Card' known as a SIM (Subscriber Identity Module) is supplied by your Cellular Service Provider. All call billing is made to the subscriber number on the card whether it is used in this or any other GSM unit.

 *Before you use your phone, please ensure that you charge your battery for at least 14 hours.*

Understanding this Manual

Explains how to use this manual 4

Safety

Important information for the efficient and safe operation of your phone 5

Using Your Phone

Introduces your phone and explains how to charge batteries and make a call 9

Menu Navigation

Explains how to access and use the phone's menus 21

Using The Phone Book Menu

Provides an explanation of the Phone Book Menu and how to use it 23

Using The Messages Menu

Provides an explanation of the Messages Menu and how to use it 29

Using The Options Menu

Provides an explanation of the Options Menu and how to use it 33

Accessories

Details the accessories available for use with your phone 55

Useful Information

Space for you to make a record of your phone book numbers and useful information 57

Index

A comprehensive index 61



The Manufacturer reserves the right to make changes in technical and product specifications without prior notice.

Understanding this Manual

The Phone Operation and Menu System

Your phone has been designed to be used in as simple and consistent a manner as possible. We have made the next, most obvious, action selectable by pressing the **OK** key.

Many of your phone options are accessed by a simple, three key, menu system. A full description of the menus and how to move around them is covered in the later section **Menu Navigation**. When the manual describes the use of each menu item, it will be assumed that you are familiar with the menu system.

The Keys

The key press features of your phone are represented in this manual using symbols, so that you may locate and use the required sequence quickly. A sequence of key presses may be shown as follows:



This means that you should press the **MENU** key followed by the **OK** key and then the **C** key, in sequence, not simultaneously.

Multiple Key Presses

Symbols, such as the following, will appear in this manual. They are not keys on the phone, but they represent multiple key presses. For example:

Phone No. - enter the required telephone number.

PIN Code - enter your Personal Identification Number.

Unlock Code - enter your unlock code.

Location - enter the location number.

The Display

The LCD display of your phone is also represented graphically within this manual, either as a full screen display such as this:







or as a line of text or symbols such as this:

Enter PIN, , 

Other Symbols

You will find the following symbols used throughout this manual:

-  A **Note** contains additional information which is relevant to the feature/item.
-  A **Caution** contains important additional information which is relevant to the efficient and/or safe usage of your phone.
-  This symbol indicates that the feature is a **Personality™** feature that can be customised to meet your requirements.
-  This symbol indicates a quick access key sequence for the feature.

IMPORTANT

For the efficient and safe operation of your GSM Cellular Telephone, *Read this information before use.*

Your GSM cellular telephone is one of the most exciting and innovative electronic products ever developed. With it you can stay in contact with your office, your home, emergency services, and others, wherever service is provided.

General

Your cellular telephone utilizes the GSM standard for cellular technology. GSM is a newer radio frequency ("RF") technology than the current FM technology that has been used for radio communications for decades. The GSM standard has been established for use in the European Community and elsewhere.

Your cellular telephone is actually a low power radio transmitter and receiver. It sends out and receives radio frequency energy. When you use your cellular telephone, the cellular system handling your call controls both the radio frequency and the power level of your cellular telephone.

Exposure To RF Energy

There has been some public concern about possible health effects of using cellular telephones. Although research on health effects from RF energy has focused for many years on the current RF technology, scientists have begun research regarding newer radio technologies such as GSM. After existing research had been reviewed, and after compliance to all applicable safety standards had been tested, it has been concluded that the product is fit for use.

If you are concerned about exposure to RF energy there are things you can do to minimize exposure. Obviously, limiting the duration of your calls will reduce your exposure to RF energy. In addition, you can reduce RF exposure by operating your cellular telephone efficiently by following the below guidelines.

Efficient Phone Operation

For your phone to operate at the lowest power level, consistent with satisfactory call quality:

If your phone has an extendable antenna, extend it fully. Some models allow you to place a call with the antenna retracted. However, your phone operates more efficiently with the antenna fully extended.

Hold the phone as you would any other telephone. While speaking directly into the mouthpiece, position the antenna up and over your shoulder.

Do not hold the antenna when the phone is "IN USE". Holding the antenna affects call quality and may cause the phone to operate at a higher power level than needed.

Antenna Care and Replacement

Do not use the phone with a damaged antenna. If a damaged antenna comes into contact with the skin, a minor burn may result. Replace a damaged antenna immediately. Consult your manual to see if you may change the antenna yourself. If so, use only a manufacturer-approved antenna. Otherwise, have your antenna repaired by a qualified technician.

Use only the supplied or approved antenna. Unauthorised antennas, modifications or attachments could damage the phone and may contravene local RF emission regulations or invalidate type approval.



Driving

Check the laws and regulations on the use of cellular telephones in the areas where you drive. Always obey them. Also, when using your phone while driving, please:

- give full attention to driving,
- use hands-free operation, if available, and
- pull off the road and park before making or answering a call if driving conditions so require.

Electronic Devices

Most electronic equipment, for example in hospitals and motor vehicles is shielded from RF energy. However, RF energy may effect some malfunctioning or improperly shielded electronic equipment.

Vehicle Electronic Equipment

Check with your vehicle manufacturer's representative to determine if any on board electronic equipment is adequately shielded from RF energy.

Medical Electronic Equipment

Consult the manufacturer of any personal medical devices (such as pacemakers, hearing aids, etc.) to determine if they are adequately shielded from external RF energy.

Turn your phone **OFF** in health care facilities when any regulations posted in the area instruct you to do so. Hospitals or health care facilities may be using RF monitoring equipment.

Aircraft

Turn your phone **OFF** before boarding any aircraft.

- Use it on the ground only with crew permission.
- Do not use in the air.

To prevent possible interference with aircraft systems, Federal Aviation Administration (FAA) regulations require you to have permission from a crew member to use your phone while the plane is on the ground. To prevent interference with cellular systems, local RF regulations prohibit using your phone whilst airborne.

Children

Do not allow children to play with your phone. It is not a toy. Children could hurt themselves or others (by poking themselves or others in the eye with the antenna, for example). Children could damage the phone, or make calls that increase your telephone bills.

Blasting Areas

To avoid interfering with blasting operations, turn your unit **OFF** when in a "blasting area" or in areas posted: "turn off two-way radio". Construction crews often use remote control RF devices to set off explosives.

Potentially Explosive Atmospheres

Turn your phone **OFF** when in any area with a potentially explosive atmosphere. It is rare, but your phone or its accessories could generate sparks. Sparks in such areas could cause an explosion or fire resulting in bodily injury or even death.

Areas with a potentially explosive atmosphere are often, but not always, clearly marked. They include fuelling areas such as petrol stations; below decks on boats; fuel or chemical transfer or storage facilities; and areas where the air contains chemicals or particles, such as grain, dust, or metal powders.

Do not transport or store flammable gas, liquid, or explosives, in the compartment of your vehicle which contains your phone or accessories.

Before using your phone in a vehicle powered by liquefied petroleum gas (such as propane or butane) ensure that the vehicle complies with the relevant fire and safety regulations of the country in which the vehicle is to be used.



Safety Standards

This Cellular Telephone complies with all applicable RF safety standards.

This cellular telephone meets the standards and recommendations for the protection of public exposure to RF electromagnetic energy established by governmental bodies and other qualified organisations, such as the following:

- **Verband Deutscher Elektroingenieure (VDE) DIN-0848**
- **Directives of the European Community, Directorate General V in Matters of Radio Frequency Electromagnetic Energy**
- **National Radiological Protection Board of the United Kingdom. GS-11, 1988.**
- **American National Standards Institute (ANSI)/IEEE. C95. 1-1992**
- **National Council on Radiation Protection and Measurements (NCRP). Report 86**
- **Department of Health and Welfare Canada, Safety Code 6.**

Battery Safety

To prevent injury or burns, do not allow metal objects to contact or short circuit the battery terminals.













Using Your Phone

Introducing Your Phone

Special Keys

-  Press to turn phone on and off.
-  Press to see more information on the current operation.
-  Press to accept call, setting, option,...
-  Press to switch privacy mute on and off.
-  Press to access the Phone Book menu.
-  Press to access the Messages menu.
-  Press to access the Options menu.
-  Press to reject call, setting, option,...

The Other Keys

The digit keys, used to enter phone numbers, security codes and other numeric items.

 Press to move backward and forward through entries.

The Flip

The flip can be used to answer and end calls.

SIM Card Release

The SIM card release button is on the left hand side of your phone. To remove the SIM card, slide this button down toward the base of the phone and pull the SIM card out.

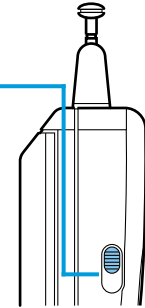

Volume Buttons

The buttons on the right hand side of your phone adjust the earpiece, keypad tone and ringer volume levels. Volume is increased with the upper button and decreased with the lower button.

Adjusting the Earpiece Volume

Press the volume buttons during a call.

Adjusting the Keypad Tone Volume

With the flip open, press the volume buttons when not in a call.

Adjusting the Ringer Volume

With the flip closed, press the volume buttons.

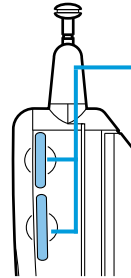

The Display

The Liquid Crystal Display (LCD) on your phone can display two rows of twelve alphanumeric characters as well as useful information symbols.



The various elements of the display are as follows:

ABC123 Characters are used to display messages and telephone numbers.



Battery Charge Level. When the battery is fully charged this symbol will be on. As the battery charge is used, the symbol will begin to flash slowly. The flash will become rapid when the battery is nearly depleted. Replace or recharge the battery at this point.



Signal Strength. The more segments displayed in the bar graph, the better the signal strength.



Power On. Displayed while your phone is switched on.



In Use. Displayed when a call is in progress.



Roam. This symbol will be on, or flashing, when you are registered on a system other than your home system.

On, for preferred networks.

Flashing, for non-preferred networks.



No Service. This symbol will be on when you are out of cellular system coverage, you will not be able to make or receive calls.

The symbol will flash, when you are in an area with coverage but are not registered on the system. You will be able to make emergency calls using the special GSM emergency number, 112, but cannot make or receive ordinary calls.



Short Message Service. When the phone has received a message this symbol will be on. The symbol will flash when your message storage area is full.

Low Temperature Use

The liquid crystal display screen used in your phone will behave differently at extremely low temperatures. You may notice that the display responds slowly to key presses, this is to be expected and does not affect the phone operation in any way.

Attaching and Using Batteries

Charging a New Battery

To ensure maximum battery performance, it is recommended that a new battery (or battery that has not been used for several months) be charged for at least 14 hours before use, but not for more than 24 hours.

- ☞ *A new battery, or a battery that has not been used for several months, may cause a premature fully charged indication on the charger. Ignore this indication and let the battery charge for several more hours, remove and re-insert the battery into the charger, and charge for an additional 14 hours.*
- ☞ *A new battery will require two to three full charge/discharge cycles in order to achieve the stated performance.*

Important Charging Information

To ensure that you enjoy maximum battery life and use your battery to its fullest capacity:

- Always use Motorola approved battery chargers.
- The battery should be at or near room temperature when charging.
- Once a week, allow your battery to discharge completely before recharging (to fully discharge, leave your phone on until it turns itself off).
- Do not leave the battery in the charger for longer than 24 hours.

Fitting Your Battery

Place the battery onto the rear of the phone just below the marked arrow indicators. Next, slide the battery upwards on the phone's moulded runners, until it locks into place.

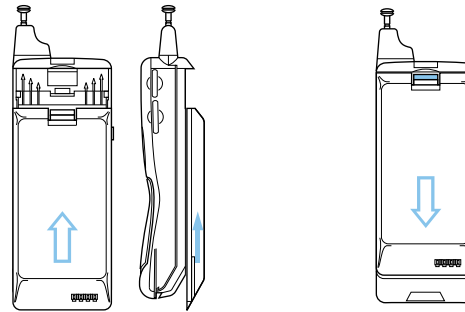

Removing Your Battery

Press the release catch inwards and simultaneously slide the battery downwards, until it reaches the end of its travel. Next, pull the battery away from the rear of the phone.

Low Battery Warning

When the battery level becomes too low for normal operation, a warning signal (two double beeps) will sound. The battery symbol  will begin to flash rapidly.

When the battery is completely discharged, your phone will turn off.



Desktop Charging of Your Battery

☞ Typical charge times for the desktop chargers are:

<i>Slim XT NiCd:</i>	<i>Overnight Charger - 10 hours</i>
	<i>Rapid Charger Base - 90 minutes</i>
<i>Ultra Slim NiMh:</i>	<i>Overnight Charger - 10 hours</i>
	<i>Rapid Charger Base - 90 minutes</i>



Adapter Connection

Two types of charger units are available for use with your phone: the Overnight Charger and the Rapid Charger Base (a rapid charging variant). Both charger models have two charging slots so that you may charge your phone and unattached batteries. The front slot can accommodate a spare battery or a battery attached to your phone. The rear slot accepts unattached batteries only.

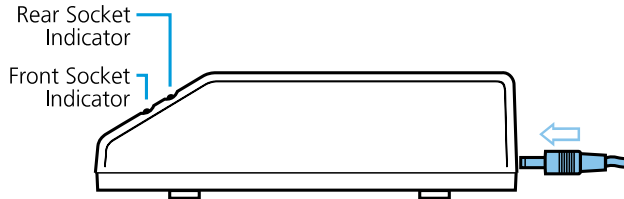

Both charger models are supplied with a mains adapter which can be plugged into a standard mains socket. The mains adapter lead can then be plugged into the socket at the rear of the charger unit.

Charger Indicators

Both chargers have two indicators at the front to provide charging status information. The lower indicator represents the front slot while the upper indicator shows charge status for the rear slot. On the Overnight Charger, the indicators are yellow and show that the phone and/or battery are being charged. The Rapid Charger Base indicators use a three colour code to show the charge status, as follows:

Red	Rapid charge
Yellow	Trickle charge
Green	Charging completed

On both chargers, when both slots are used, the front slot will be serviced first, followed by the rear slot.

- ! *It is normal for batteries to become warm during charging.*
- ! *Do not leave batteries to charge for more than 24 hours.*

Inserting Your Phone into the Charger

Tilt your phone back until it rests at the same angle as the cut away front panel of the charger. Next, guide your phone into place in the front slot, until the lower indicator lights up.

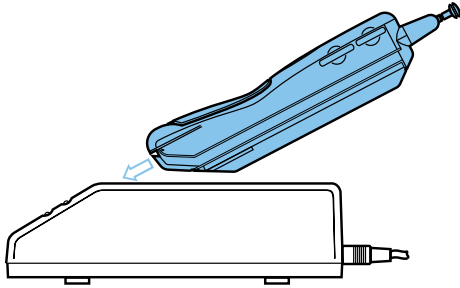

Inserting a Spare Battery into the Charger

If you wish to insert a spare battery at the same time as charging your phone, slide the battery into the rear slot, at the angle shown, until the upper indicator lights up.

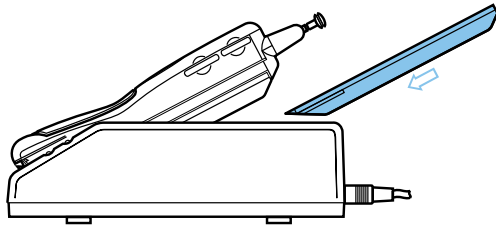

Using Your SIM Card

SIM Card Insertion

The SIM card can be inserted into the phone at any time, before or after the phone is switched on.

Insert the SIM card into the slot in the base of the phone, as shown.

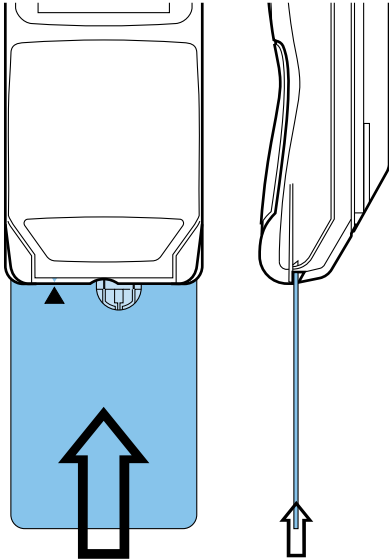

If the SIM card is inserted the wrong way round, or damaged, the **Check Card** message may be displayed. Remove the SIM card, check that it is the right way round and then re-insert it into the phone.

If either of the **Bad Card See Supplier** or **Blocked See Supplier** messages are displayed, then you will need to contact your Cellular Service Provider.

SIM Card Removal

Push the release button towards the base of the phone and pull the SIM card out. The SIM card can be removed at any time, before or after the phone is switched off.

Switching the Phone On and Off

To switch the phone on or off press the **⏻** key.

If you are switching the phone on and there is no SIM card inserted, you will be asked to insert one. Once inserted, the phone will check that the SIM card is valid.

Two security codes may be requested at this point:

- the SIM card PIN code
- the phone unlock code.

Entering Your SIM Card PIN Code

To enter the PIN code, press **PIN Code** **OK**.

As you type in each digit of the PIN code a * character will be displayed.

If you have made a mistake, pressing and releasing the **C** key will remove the last digit. Holding the **C** key down will remove the entire entry.

When the PIN code is complete press the **OK** key.

If the PIN code entered is incorrect, the warning message **Wrong PIN** will be displayed, followed by **Enter PIN**.

! *If the PIN number is entered incorrectly three times in a row, your phone will automatically lock-up and the **Blocked** message will be displayed.*

The code can be changed, see 'Change SIM PIN Code' in the **Options Menu** section for more details.

Unlocking Your SIM Card

To unblock your SIM card, enter the following key sequence:

⬅ * ⬅ * 0 + 5 *ⓂⓁ ⬅ * **Unlock Code **OK****
****New PIN Code** **OK** **New PIN Code** **OK****

The 8 digit unblocking code will have been provided with your SIM card by your Cellular Service Provider.

The new PIN code must contain four to eight digits.

! *If this operation is performed incorrectly 10 times in a row, your SIM card will become permanently blocked.*

OK Entering Your Unlock Code

If your phone displays the message **Enter Phone Unlock Code** you must enter your unlocking code by pressing

Unlock Code **OK**.

The unlock code is a four digit number which is set at manufacture to **1234**. The code can be changed, see 'Change Unlock Code' in the **Options Menu** section for more details.



Phone Calls

To make or receive a phone call, your phone must be switched on, unlocked and have the antenna fully extended.

If the ∅ symbol is showing, your phone has been unable to find a cellular service. It will not be possible to make or receive a phone call unless you move to an area where there is a GSM service. When a service has been found, a series of rising bars, , will show the signal strength.







There are a number of different ways to make a phone call:

- Using the digit keys.
- Using automatic redial.
- Redialling the last number called.
- One touch dialling a Phone Book entry*.
- Dialling a Phone Book entry*.
- Calling an embedded number in a message.

 *Your phone contains a 'phone book' that can be used to store names and telephone numbers.

Making a Phone Call

The simplest method of making a phone call is to enter the number using the digit keys then press .

 If you make a mistake, press and release the  key to remove the last digit. Holding the  key down will remove the entire number.

Your phone will then attempt to make the phone call. The display will show **Calling** to show the call attempt is being made. If the call is not answered, pressing , or closing the flip, at this point will end the attempt.

When the phone call is answered, the display will change to **Connected** for a few seconds, followed by **End Call?**.

To end your call press , or close the flip.

If service is temporarily interrupted during a phone call, the message **Reconnecting** may appear. Your phone will automatically try to reconnect the call if possible.

Automatic Redial

If your call attempt does not succeed, the message **Redial?** will be displayed for five seconds. Pressing  at this point will automatically redial the phone number.

When the call is answered, you will hear a short ring tone.

The maximum number of redial attempts is set by your Cellular Service Provider. If the phone call cannot be connected within this maximum, the message **Redial Failed** will be shown.

Redialling the Last Number Called

To call the last number dialled, press the **OK** key when in standby mode. The last number dialled will be shown in the display, press **OK** to call the number.

OK One Touch Dialling Phone Book Numbers

To quickly retrieve and dial a number stored in Phone Book locations 1 to 9, press and hold the appropriate digit key. For example, pressing and holding **2 ABC** will dial the phone number stored in location 2 of your Phone Book.

 You do not need to press **OK** to call the number.

OK Dialling Phone Book Numbers

To quickly retrieve a number from your Phone Book:

Press **Location**. For example **2 ABC 3 DEF** will retrieve the phone number stored in location 23 of your Phone Book.

Press **OK OK** to call the number.

Calling an Embedded Number in a Message

Details on how to call a number embedded in a message are given in *Using the Messages Menu*.

International Phone Calls

To make an international phone call press and hold the **0 +** key. After a couple of seconds the international dialling prefix **+** will appear in the display, this allows you to call from any country without knowing the local international access code.



Now enter the country code, followed by the phone number. The country code follows the conventional format, 49 for Germany, 44 for the UK, 46 for Sweden, etc.

Just like a conventional international call, remove the leading '0' of the area code when you dial.

The *Useful Information* section at the end of this manual contains a list of the more commonly used international dial codes.





Inserting Pauses Into Phone Numbers

To obtain a three second 'pause' character in a phone number, press and hold the  key for a couple of seconds, the pause symbol  will appear.

The pause character produces a three second delay whenever it is used. However, the first pause character in a phone number is a special case, it will not begin its delay until the call is answered.



Pause - A Working Example.

If, for example, you have a tone-based voicemail system on 555-6911, with a mailbox number 1066# and password 2001#. Then you may dial the following number **555691110662001**.

The first part of the number would be used to call the voicemail system.

When the call is answered the first pause will produce a delay of three seconds before the tones for **1066** are sent to select the mailbox.





There will be a second pause of three seconds before the tones for **2001** are sent as the password.

GSM Emergency Calls

The worldwide GSM network provides a standard number, 112, to dial in cases of emergency.

Provided that your phone has found a network, you will be able to make an emergency call. The call can be made with or without a SIM card inserted and regardless of any security codes.

The emergency call will be directed to a central emergency operator.

To dial the GSM emergency number, press    .

While the emergency call is being made and connected, the display will show **Emergency**.

Receiving a Phone Call

When your phone receives a call, it will ring and the display will show the **Call** message (if the caller's phone supports the Caller Line Identification option, their number will be displayed instead).

Press **OK** or open the flip to answer the call.

If you do not wish to answer a call you can either:

Press and release the **C** key. If you have enabled the 'Detailed Diverting - If Busy' option in the *Options Menu*, the caller will be diverted to the forwarding number, otherwise the caller will hear the busy tone.

or

Press and hold the **C** key. This will reject the incoming call. No call divert option will be offered.

If your phone rings and you do not answer it, the message **Unanswered Call** will be displayed to show you that a call attempt was received.

Ending a Phone Call

To end a phone call, press **OK** or close the flip.

OK Storing Numbers in the Phone Book

You can store up to 255 names and telephone numbers in your Phone Book. Full details on how to use the Phone Book are given in the *Using the Phone Book* section, however, the following steps provide a brief overview of how to store a number in the Phone Book.

- 1 Press and hold **OK** to access the Phone Book.
- 2 Press **OK** to choose whether to store the number in the phone memory or the SIM card memory. (If you store the number on your SIM card then it is accessible if you use your SIM card in another phone.) Press **OK**.
- 3 When prompted, enter the number you wish to store (remember to include the full area code) followed by **OK**.
- 4 When prompted, enter the name followed by **OK** and then the location number followed by **OK**.
- 5 The phone will confirm the location of the stored number, for example: **Stored 123**.



DTMF Tone Dialling

The tones produced by your phone when you press the keys are known as Dual Tone Multi Frequency tones, or DTMF tones for short.

Some possible uses of the DTMF tones are to:

- Get messages from answering machines.
- Signal pagers.
- Control tone operated voice/mail systems.



Your phone will produce DTMF tones when you press the following keys:

0 + , **1** , ... , ... , **8** tuv , **9** wxyz , ***** or **#** **>**

When you press these keys during a phone call, the DTMF tones will be produced and the display will show the keys pressed.

In addition to showing the keys pressed, the display will also show **Call ?**. This message will be removed, three seconds after the last key press.

If you press **OK** at this point, your phone will place the current call on hold and attempt to call the number entered.

OK Phone Services

Your phone offers a number of services that enable you to make more efficient use of the GSM network and your time.

The following services are provided:

- Call Holding and Call Waiting - allows you to place a current phone call on hold and either accept an incoming call or start a second call.
- Call Diversion - allows you to divert incoming calls to another phone number.
- Short Message Services - allows you to receive text messages.
- Call Metering - provides you with individual and total call times or costs.
- Network Selection - allows you to travel and be able to select different cellular networks so that you always have the best coverage.

These services are covered in detail later in this manual.

What is Menu Navigation?



A large number of your phone's options are accessed by using menus. The Phone Book, Short Message Services and Options menus all use a common approach for selection, change and cancellation.



Please read this section carefully before attempting to access a menu option. When you understand the common approach to menu navigation and how the menus are shown on the page, you will be able to access and change options with ease.

The menus described here can only be accessed when the phone is in the standby mode. Menu operation is not possible when you are making or answering a phone call.



Entering the Menus

Three different keys are used to access the three menus:



-  accesses the Phone Book menu
-  accesses the Messages menu
-  accesses the Options menu

Once entered, each of these menus use the ,  and  keys in a common manner to access and change individual options.

Leaving the Menus

To leave any of the menus, you can either, press and hold the  key or repeatedly press the  key. Both of these actions will return your phone to the standby mode.

Moving to and Selecting a Menu Option

Each time you press the  key, the next menu item at the current level is displayed. This menu item will not be 'selected' unless you press the  key.

Some of the menu items are merely a means of accessing a sub-menu. When a sub-menu is selected, pressing the  key will display the next sub-menu item.

To leave an option or sub-menu, press the  key. This will take you back to the 'parent' menu item.

Menu Options with Multiple Settings

Many of the options have multiple settings, such as **On** or **Off**, or **High**, **Medium** or **Low**. The current setting of such options will be indicated by the **B** character.



Menu Options with Security Codes

Some options are protected from misuse by requiring you to enter one of the security codes. In order to use these options, you must enter the requested code before proceeding.

Confirmation Messages

When you change the setting of an option, it will confirm that the change has been made.

Menu Navigation - A Working Example

If you wish to switch the Extended Menus option on or off, then follow these steps:

- 1 When the phone is in the standby mode, press the **MENU** key. This will access the Options menu.
- 2 Press the **MENU** key again, the display will now show the 'Call Related Features' menu item.
- 3 Press the **MENU** key to go to the next menu item. The display will now show the 'Phone Setup' menu item.
- 4 Press the **OK** key to select the sub-menu. The display will now show the 'Adjust Ring Volume' menu option.
- 5 Press the **MENU** key five times to go to the 'Extended Menus' sub-menu item.
- 6 Press the **OK** key to select this option. You will now be able to change the setting of this option.

When you get to the end of a menu it repeats.

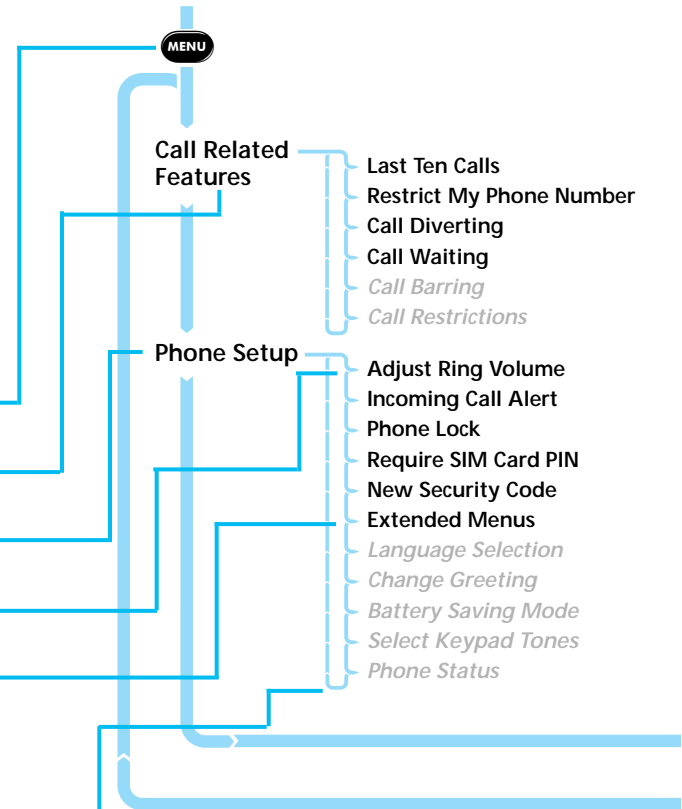

Using The Phone Book Menu



What is the Phone Book ?

You can store up to 255 names and telephone numbers as entries in an electronic 'Phone Book'. These entries are stored in both the phone's and SIM card's memory and can be used for fast dialling.

Your phone can store 100 entries and the SIM card can store up to 155 entries. The number of SIM card entries will vary depending upon the type of SIM card issued by your Cellular Service Provider.

Each Phone Book entry comprises:

- A telephone number. Up to 32 digits can be stored, but this is reduced to 20 digits for SIM card locations.
- A name. Up to 16 characters for phone locations. Up to 50 characters for SIM card locations, but typically 10 or less.
- A location label from 1 to 255.

To access the Phone Book menu press the  key. **Phone Book Options** will appear, a second press of the  key will display the **Find Entry By Name** menu item. Use the navigation keys ,  and  to select the Phone Book option you wish to use.



How to Enter a Name

The **0+**, **1**,, **8TUV** and **9WXYZ** keys are used to enter characters when you are asked to enter a name.

For example, if you press the **5JKL** key, the first displayed character will be **J**. If this is not the required character, then you can press the same key again to show **K**. Another press will display **L**, another... ..will display **5**. Your phone will continue to scroll through the characters available on the selected key with each new key press.

A long press of any of the keys will switch all the characters to lower case, a second long press will switch back to upper case.



To enter the next character press the appropriate key. If, however, the next character is on the same key as the previous character you will first need to press the **#>** key. Pressing the **#>** key a second time will produce a space.

If a mistake has been made, you can go back to the incorrect character by pressing **<***.

Characters can be removed from the name by pressing the **C** key.

The character *before* the cursor (**ö**) is the character which will be deleted.

When the name is complete press the **OK** key.

Available Characters for Names

Press the appropriate keys to get the following characters:

1	Space . ? ! , & : " () ' ` % i c 1 Space . ? ! , & : " () ' ` % i c 1
2ABC	A B C [® ± ¼ ¾ © 2 a b c { - ± ½ ¾ © 2
3DEF	D E F ° ¿ ¨ ≈ 3 d e f ° ¥ ¨ ≈ 3
4GHI	G H I À \$ 4 g h i À \$ 4
5JKL	J K L Á 5 j k l Á 5
6MNO	M N O] \ « » µ 6 m n o } ~ " µ 6
7PQRS	P Q R S Â ¾ , 7 p q r s Â ¾ , 7
8TUV	T U V ^ ^ 8 t u v ^ ~ 8
9WXYZ	W X Y Z ° · 9 w x y z ° · 9
0+	+ - x * / = > < # 0 + - x * / = > < # 0

The top line(s) for each key show the upper case characters, the lower line(s) show the lower case.

The Phone Book Menu Items

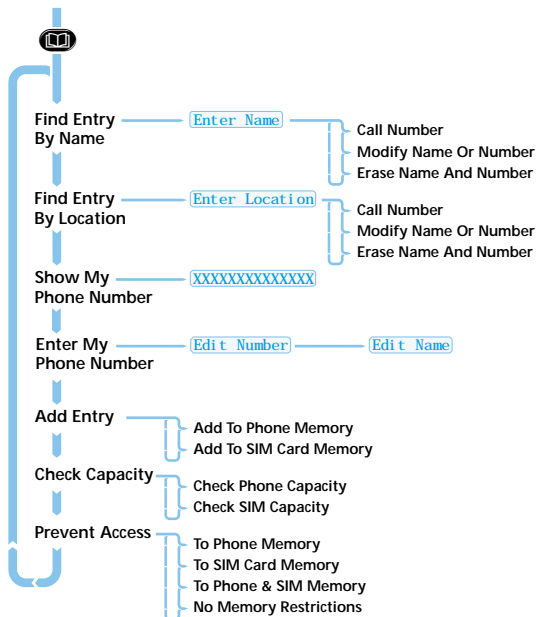

Menu Navigation



Find Entry By Name

This option is used to select a telephone number from a list of alphabetically sorted Phone Book names.

Once selected, this option will display the message **Enter Name**. You can enter the first three characters of a name. You do not need to enter all three characters, but a longer entry will result in a more accurate search.



The Phone Book entries will be searched and the first matching entry will be displayed.

If you did not enter any name information, the first alphabetical entry will be displayed.

If there are no names stored, **No Names Stored** will be displayed.

To display adjacent Phone Book entries use the **← * →** and **# →** keys. When the desired name is displayed press the **OK** key to select it. The phone will now enter the 'Call Number', 'Modify Name Or Number' or 'Erase Name And Number' options sub-menu.

Find Entry By Location

 Press  **Location** - you must enter the location within two seconds.



This option is used to select a telephone number from a list of numerically sorted Phone Book locations.

Once selected, this option will display the message **Enter Location**. You can now enter a location number. If the entered location is not valid, a timed message **Range 1-XXX** will be displayed and the phone will return to the **Enter Location** menu item.

The Phone Book entries will be searched and an entry will be displayed.

If you did not enter a location, the first numerical entry will be displayed.

If there are no names stored, **No Numbers Stored** will be displayed.

To display adjacent Phone Book entries use the  and  keys. When the desired name is displayed press the  key to select it. The phone will now enter the 'Call Number', 'Modify Name Or Number' or 'Erase Name And Number' options sub-menu.

Show My Phone Number

This option can be used to display your telephone number.

 You may need to enter your phone number into memory before you can display your number - see 'Enter My Phone Number'.

Enter My Phone Number

Use this option to store your phone number for future reference.

Call Number, Modify Name Or Number or Erase Name And Number Options

Once a Phone Book entry has been selected, it can be used to make a call to, modify or erase an entry.

Call Number

This option is used to call the selected Phone Book telephone number.

Simply press the  key when the phone displays the message **Call Number**.

Modify Name Or Number

This option is used to change the selected Phone Book entry.

The entries current telephone number and name will be presented, in turn, for modification. You can accept the current settings or modify as required.

The option will display the timed message **Modified XXX** and then return to the **Find Entry** menu item.



Find Entry
By Name

Find Entry
By Location

Show My
Phone Number

Enter My
Phone Number

Add
Entry

Check
Capacity

Prevent
Access

Erase Name And Number

This option is used to erase the selected Phone Book entry.

Simply press the **OK** key when the phone displays the message **Erase Name And Number**. The option will display the timed message **Erased XXX** and then return to the **Find Entry** menu item.

Add Entry

 Press and hold **OK**. You will be prompted to add an entry.

This option is used to add (store) entries to the Phone Book. You can choose to add the new entry to either the phone or SIM card memory locations.

Add To Phone Memory, Add To SIM Card Memory

Once you have selected the destination of the new entry, you will be asked to enter the telephone number, name and location number of the new entry.

The last telephone number dialled, will be presented by default, it can be used or discarded as required.

If the entered location is not valid, a timed message **Range YYY-ZZZ** will be displayed and the phone will return to the **Enter Location** menu item. If the chosen location is currently used by another entry, you will be asked for confirmation that the location can be overwritten.

If you do not supply a location number, the next available location will be used.

When the new entry has been entered, a timed message **Stored At XXX** will be displayed and the phone will return to the **Add Entry** menu item.

Check Capacity

This option is used to check the number of free Phone Book entries in the phone or SIM card memory areas.

Check Phone Capacity, Check SIM Capacity

Once selected, a timed message **XX Unused Locations** displays the requested information. The phone will return to the **Check Capacity** menu item.

Prevent Access

This option enables you to prevent access to the Phone Book information.

To Phone Memory, To SIM Card Memory, To Phone & SIM Memory, No Memory Restrictions

The entries in the phone and SIM card can be restricted individually or together. To allow unrestricted access to all entries, this option can be disabled.

When you change the restrictions, you will be requested to enter the Security Code before the change is made.





Using The Messages Menu

What are Short Message Services?

The Short Message Service, or SMS, is a GSM network feature that allows you to receive two types of text messages:

Point to Point Messages

These are text messages that are sent specifically to your phone number.

When a point to point message is received, your phone:

- 1 Makes three short alert tones.
- 2 Displays the  (messages) icon.
- 3 Stores the message for later viewing, if there is space.

Cell Broadcast Messages

These are general messages, broadcast to a group of phones and can only be received when your phone is in standby mode.

These messages are broadcast in numbered 'channels' and, in general, each channel will tend to carry one particular type of information.

Typical cell broadcast channels could have information on local weather conditions, traffic reports or stock market prices. Please contact your network operator for a list of available channels and the information they supply.

When your phone receives a cell broadcast message, it will attempt to scroll the message across the display. Your phone will be unable to display a message if you have entered a partial phone number, as the **Call?** prompt uses the same display area. To remove the **Call?** prompt press and hold the **C** key.

When the message has scrolled across the display, the beginning of the message will be shown until you either, remove it or a new message arrives.

To start or stop scrolling press the **⏪*** key. The **#⏩** key will restart scrolling from the beginning of the message.

To remove a displayed message, press the **C** key.



The Messages Menu Items

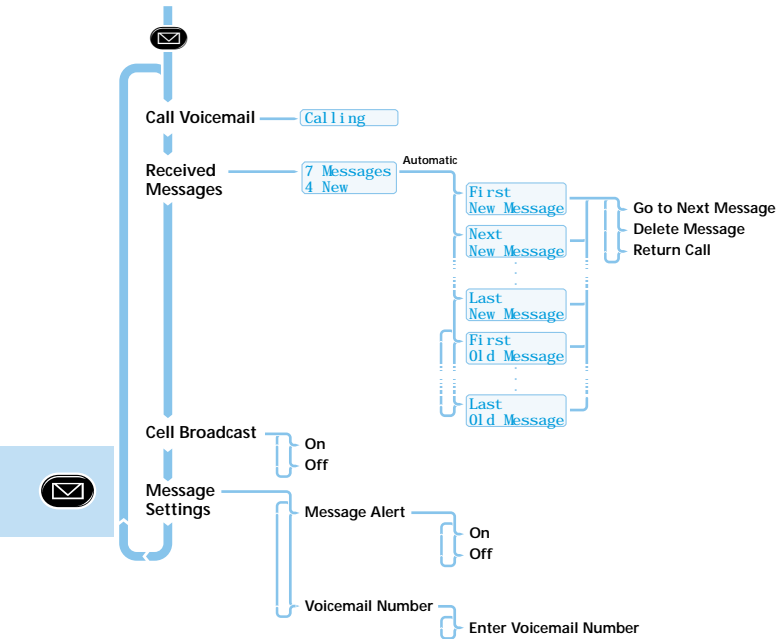

OK Call Voicemail

Once selected, this option will leave the Messages menu and automatically make a phone call to the current voicemail number. The display will show **Calling** and standard call operations can be performed.

The voicemail phone number can be entered by selecting the 'Voicemail Number' option in the 'Message Settings' sub-menu.

Menu Navigation





Received Messages

This option is used to view and manage any Point to Point messages, that have been sent to your phone number/SIM card.

When a Point to Point message is received, your phone will attempt to store it in your SIM card. If there is not enough space, the  icon will flash. One or more messages must be removed before the message can be stored.

Your Cellular Service Provider will transmit a message for a limited amount of time. If a memory location is not made available before the message is removed from the network, then you will not be able to receive or read it.

When selected, this option will display a message indicating the total number of messages and how many of these are new, if any. **No Messages** will be displayed if there are none and the phone will return to the 'Received Messages' menu item.

If there are messages, the new messages will be displayed first, followed by the old. Repeated presses of the  key will display the whole message, when it was sent and the phone number who sent it (if available).

Once you have read a new message it will automatically become old.

Press the **OK** key, when viewing any message, to enter the 'Go to Next Message', 'Delete Message' and 'Return Call' sub-menu.

Go to Next Message

This option will display the next stored message.

If you are currently viewing the last old message, your phone will either display the first new message (if there is one) or the first old message.

Delete Message

This option will delete the currently viewed message

Return Call

This option can be used to call the person who sent you the message, if their number has been included by the network, or a number that has been included in quotes " " in the message.





Cell Broadcast

This option is used to set the cell broadcast settings.

The option has two settings **On** or **Off**.

If you change the setting to **On**, you will be asked to enter the channel you wish to receive information from.

Please contact your Cellular Service Provider for a list of available channels and the information they provide.

Message Settings

OK Message Alert

Your phone can notify you with an audible tone when a message is received. This option is used to switch the alert tones **On** or **Off**.

OK Voicemail Number

This option is used to enter a phone number which will be used by the 'Call Voicemail' option.

If there is already a Voicemail Number, this will be shown in the display. This can be used, modified or deleted as desired.

Using The Options Menu

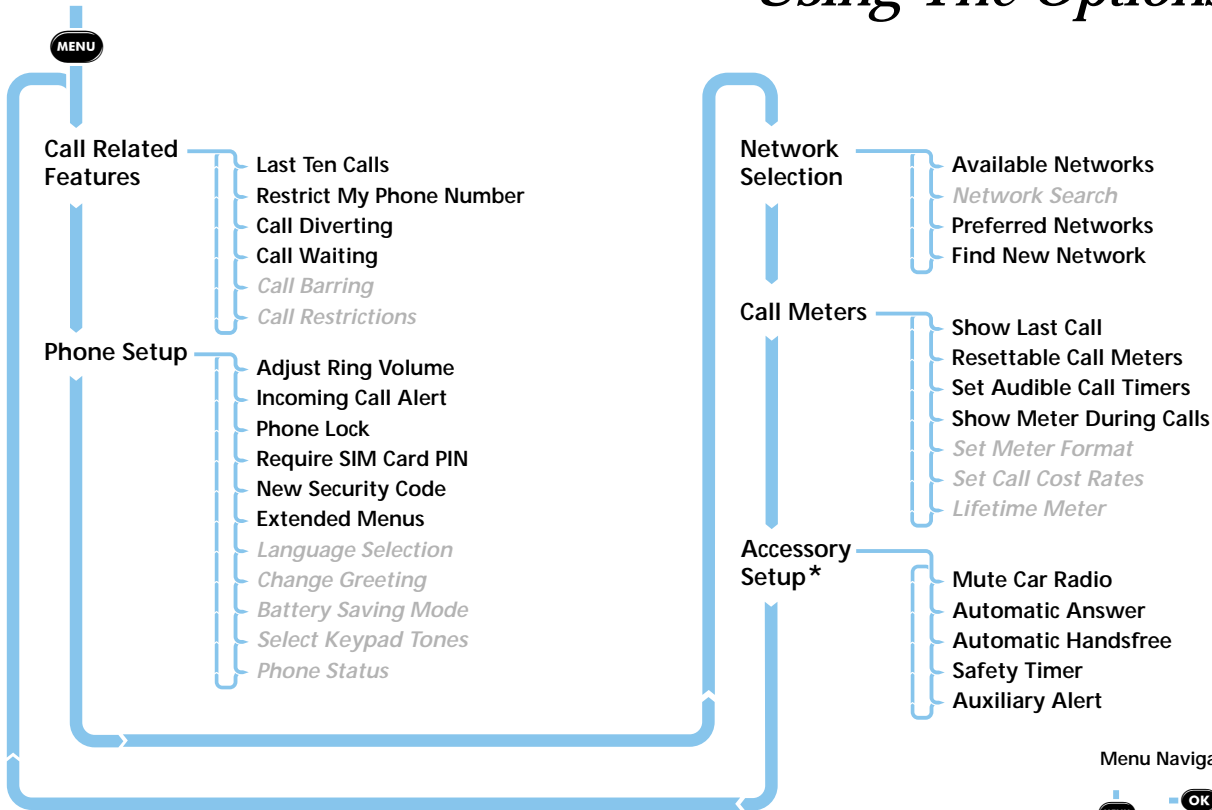

Menu Navigation



Items shown in *italics* are available only when **Extended Menus** are enabled.

* The **Accessory Setup** section is available only when a car kit is fitted.

OK *Short, Extended and Personalised Menus*

With **Personality**[™] you can personalise the Options Menu by choosing which features you want quick access to. The features that are less frequently used can be stored out of sight.

The menu diagrams in this manual show the condition of the menu settings when you first receive your phone. Some features are in the Short Menu and are shown in **bold** type. Other features are in the Extended Menu and appear in shaded *italics* - these features do not appear when you first scroll through the Options Menu.

You can change which features appear in the Short and Extended Menu, and therefore personalise the Options Menu, to suit your requirements.

If you want to move a feature from the Short Menu to the Extended Menu (or from the Extended Menu to the Short Menu), **a long press of the  key** will offer you the following choices:

- Add the current feature to the Short Menu/Extended Menu.
- Leave the current feature in the Short/Extended Menu.

Once selected, the menu settings will change accordingly and your phone will return to the Options Menu.

 *The settings for some menu features cannot be changed.*

The 'Extended Menus' feature in the Options Menu allows you to scroll through all the features in the Short and Extended menus.

MENU

Call Related Features Menu Items

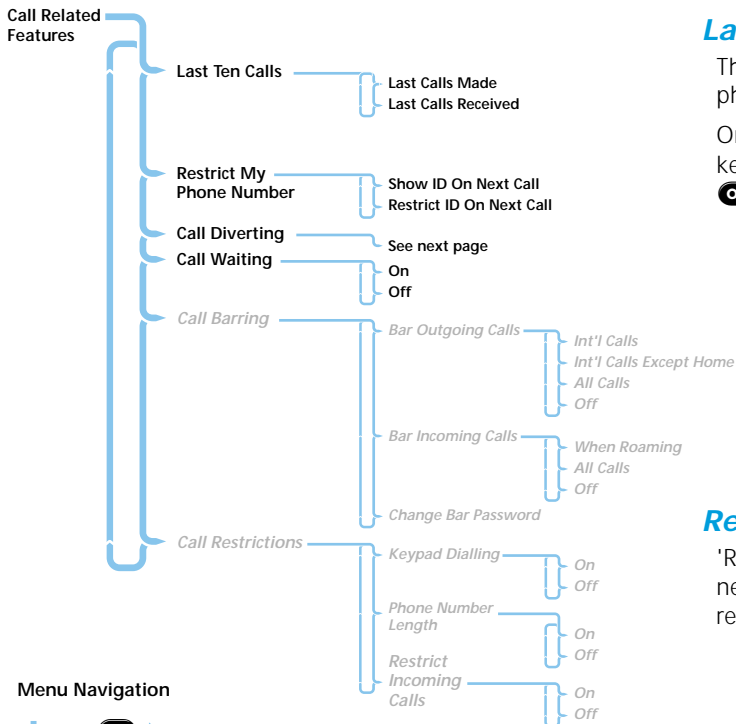

Menu Navigation



Items shown in *italics* are available only when **Extended Menus** are enabled.

Last Ten Calls

These options can be used to call the most recently used phone numbers.

Once an option has been selected, use the **◀** and **▶** keys to scroll through the list of phone numbers. Press the **OK** key to call the displayed number.

Last Calls Made

This option can be used to redial the phone number of any one of the last ten calls made.

Last Calls Received

This option can be used to redial the phone number of any one of the last ten calls received.

Only calls from phones that supply their own phone number will be stored in the calls received list.

Restrict My Phone Number

'Restrict My Phone Number' is a network feature. You will need to subscribe to one of the two Caller Line Identification restriction features with your Cellular Service Provider.

MENU



Show ID On Next Call

Your phone number is sent with the next attempted call, after this your phone number will not be sent until you re-select this option.

Restrict ID On Next Call

Your phone number will not be sent with the next attempted call, after this your phone number will be sent with calls until you re-select this option.

OK Call Diverting

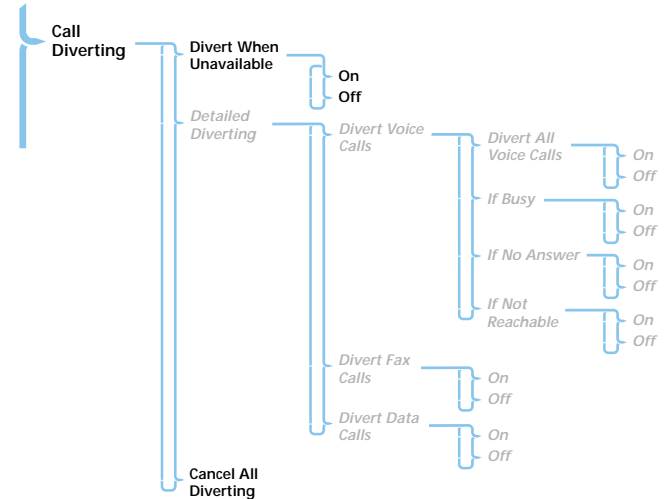

Call diverting is a network feature. If your phone is unavailable, or you do not wish to receive calls, incoming calls can be diverted to other phone numbers.

This option can be used to:

- Divert *all* incoming call types to a *single* number, whenever your phone is unavailable, or,
- Divert calls to *different* numbers, depending upon the call type and the current status of your phone, or,
- Switch call diversion off.



Divert When Unavailable

This option will enable you to divert *all* incoming calls to a *single* number, whenever your phone is unavailable.

After selecting this option, there will be a short delay while the phone asks the network for the current setting.

The option has two settings, **On** or **Off**.

If you change the setting to **On**, you will be asked to enter a diversion phone number by using the digit keys.

! *If you change this option to **On**, the detailed diversion settings for 'If Busy', 'If No Answer' and 'If Not Reachable' will be changed automatically.*

Detailed Diverting

These options will enable you to divert calls to *different* numbers, depending upon the call type and the current status of your phone.

Each of the following detailed diverting options operate in the same way.

After selecting an option, there will be a short delay while the phone asks the network for the current setting.

Each option has two settings, **On** or **Off**.

If you change the setting to **On**, you will be asked to enter a diversion phone number by using the digit keys.

! *If you change any of the settings for 'If Busy', 'If No Answer' and 'If Not Reachable', then the 'Divert When Unavailable' setting will be automatically changed to **Off**.*

Divert Voice Calls

Divert All Voice Calls

When selected, this option will *unconditionally* divert *all* incoming calls. You will have no opportunity to answer an incoming call.

If Busy

When selected, this option will divert incoming calls, if your phone is busy.

If No Answer

When selected, this option will divert incoming calls, if you do not answer the call.

If Not Reachable

When selected, this option will divert incoming calls, if your phone cannot be contacted by the network.

Divert Fax Calls, Divert Data Calls

When selected, these options will divert incoming 'Fax' and 'Data' calls.

Cancel All Diverting

This option will enable you to cancel the diversion of incoming calls.

After selecting this option, there will be a short delay while the phone asks the network to cancel all diversion settings.



OK *Call Holding and Call Waiting*

Your phone supports the GSM network options of Call Holding and Call Waiting. Using these options you can place a current phone call on hold and either, accept an incoming call or start a second call.

The Call Holding and Call Waiting options are selected by using the **MENU** and **OK** keys. By repeatedly pressing the **MENU** key, you will see the current hold/wait options. When you see the desired option, press the **OK** key to accept.

If this option is disabled, you will not be notified of waiting calls. The waiting caller will either receive the busy tone or be diverted by the 'Detailed Diverting - If Busy' option.

Call Holding and Call Waiting Scenarios

The precise function of the **MENU**, **OK** and **C** keys when used for call hold/wait options will depend upon the call status at the time.

The valid scenarios are as follows:

A call is active:

- OK** The active call ends and your phone is available for further calls as normal.
- C** As above.
- MENU** Offers the following options:

Hold Call?

If accepted, the active call is held and **Call Holding** will be displayed.

A call is active and there is a call waiting:

- OK** The active call is held, the waiting call is connected and **2 Calls** will be displayed.
- C** The waiting call is rejected and the display will return to the normal call display.
- MENU** Offers the following option:

End Active Call?

If selected, the active call ends. The waiting call now becomes a normal incoming call which can be received by pressing **OK**.

Reject Call Waiting?

If selected, the waiting call is rejected and the display will return to the normal call display.

A call is held:

- OK** The held call is reconnected and **Connected** will be displayed.
- C** The held call ends and your phone is available for further calls as normal.
- MENU** Offers the following options:

Make New Call?

If selected, you will be asked to enter the new number to call. The currently held call will remain on hold during the new call.

End Held Call?

The held call ends and your phone is available for further calls as normal.



A call is held and there is a call waiting:

OK The waiting call is connected and **2 Calls** will be displayed.

C The waiting call is rejected.

MENU Offers the following options:

Reconnect Held Call?

If selected, the held call is reconnected and the waiting call is still waiting.

Reject Call Waiting?

If selected, the waiting call is rejected.

End Held Call?

If selected, the held call ends. The waiting call now becomes a normal incoming call which can be received by pressing **OK**.

A call is active and a call is held:

OK The active call ends and the held call is reconnected.

C As above.

MENU Offers the following options:

Switch Calls?

If selected, the active call is held and the previously held call is reconnected, **2 Calls Connected** will be displayed.

End Held Call?

If selected, the held call ends and the display will return to the normal call display.

A call is active, a call is held and there is a call waiting:

OK The waiting call is rejected and the display will return to the **2 Calls** display.

C As above.

MENU Offers the following options:

End Active Call?

If selected, the active call ends. The held call remains held and the waiting call is still waiting.

Switch Calls?

If selected, the active and held calls swap.

End Held Call?

If selected, the held call ends, the active call remains active and the waiting call still waits.

MENU



Call Holding and Call Waiting Messages

During Call Holding and/or Call Waiting operations, your phone may display one, or more, of the following messages:

Trying

A request to hold the active call, or swap the active call with a held call, has been made.

or

A request to reconnect the held call has been made.

Hold Failed

The request to hold a call has been unsuccessful.

Cannot Hold Second Call

A call is already on hold, you cannot place two calls on hold at the same time.

Reconnect Failed

The held call could not be made active again.

Busy Try Later

Your phone is still working on a previous command. Wait a short time before repeating the command.

OK Call Barring

Call barring is a network feature which can be used to selectively bar outgoing and incoming calls.

If you change the barring setting, you may be asked to enter your barring password. There will be a short delay while the phone notifies the network of the new setting. When the change has been made by the network, the phone will display a confirmation message.

The *initial* password will be supplied to you by your Cellular Service Provider when you subscribe to this service.

Bar Outgoing Calls

After selecting this option, there will be a short delay while the phone asks the network for the current setting.

Barring Int'l Calls

When selected, this option will bar outgoing international calls.

Barring Int'l Calls Except to Home

When selected, this option will bar outgoing international calls, except those to your home country.

All Calls

When selected, this option will bar *all* outgoing calls, except emergency calls.

Off

When selected, this option will disable all call barring for outgoing calls.

MENU



Bar Incoming Calls

After selecting this option, there will be a short delay while the phone asks the network for the current setting.

When Roaming

When selected, this option will bar incoming calls when you are roaming.

 *Roaming, indicated by the ▲ symbol in the display, is when you are registered on a network other than your home network.*

You may wish to select this option, as some Cellular Service Providers charge an additional fee for receiving calls when you are roaming.

All Calls

When selected, this option will bar *all* incoming calls.

Off

When selected, this option will disable all call barring for incoming calls.

Change Bar. Password

This option can be used to change the call barring password.

After selecting this option, you will be asked to enter the current password.

You will then be asked to enter, and then re-enter, your new, **4 digit**, barring password. When the change has been made by the network, the phone will display a confirmation message.

OK Call Restrictions

These options can be used to limit outgoing and incoming calls. They are phone based options, you do not need to subscribe to call barring to use them.

Keypad Dialling

This option can be used to restrict your phone to dialling numbers stored in your phone and SIM card memory. You will not be able to use the digit keys to make a call.

The option has two settings, **On** or **Off**.

Phone Number Length

This option can be used to limit the number of digits allowed in a phone number. By setting this limit, you may be able to restrict access to international or long distance calls.

The option has two settings, **On** or **Off**.

If you change the setting to **On**, you will be asked to enter the maximum phone number length by using the digit keys.

Restrict Incoming Calls

This option can be used to stop your phone from receiving incoming calls. It is a phone based option, you do not need to subscribe to call barring to use this option.

The option has two settings, **On** or **Off**.



Phone Setup Menu Items

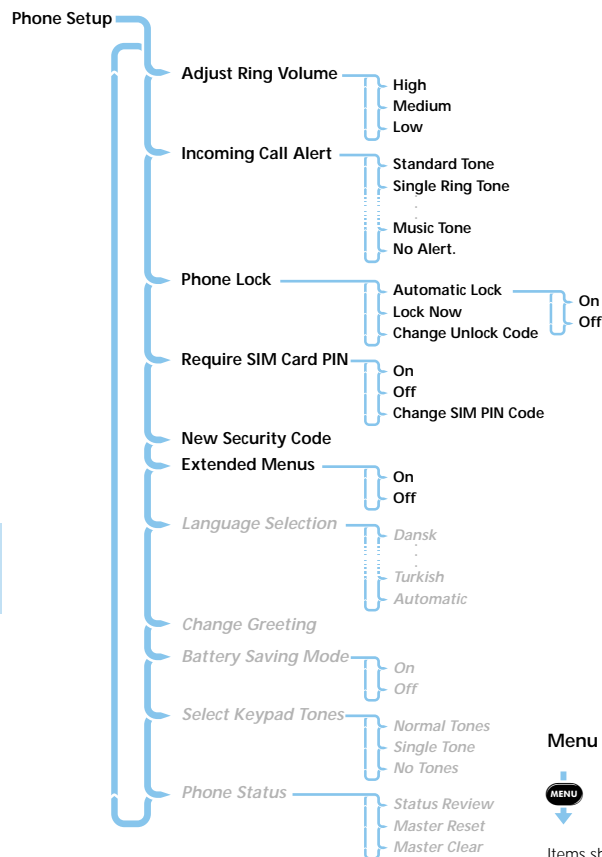

Adjust Ring Volume

This option is used to set the incoming call ring tone volume. The option has three settings, **high**, **medium** or **low**.

OK Incoming Call Alert

This option sets the way your phone alerts you to an incoming call.

Standard Tone

Your phone makes a standard ringing tone.

Single Ring Tone,... .., Music Tone

When selected, your phone will produce one of these alternative alert tones.

If you select the Single Ring Tone option, the phone will only ring once when a call is received.

No Alert

Your phone will alert you to an incoming call by displaying a message.

Menu Navigation

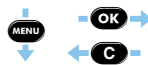

Items shown in *italics* are available only when **Extended Menus** are enabled.



OK Phone Lock

This option is used to set, and change, the unlock code.

The unlock code can be set to protect your phone from unauthorised use. It can be set to automatically lock your phone each time it is switched on.

The unlock code is a four digit number which is set at manufacture to **1234**. This can be changed at any time by using the 'change unlock code' option.

Automatic Lock

This option can be used to automatically lock your phone each time it is switched on.

The option has two settings, **On** or **Off**.

Lock Now

This option can be used to immediately lock your phone. Once selected, your phone will be unusable until the unlock code is entered.

Change Unlock Code

This option is used to change the unlock code.

After selecting this option, you will be asked to enter the current security code before you can proceed.

You can now enter a four digit code to replace the old code.

Require SIM Card PIN

This option is used to set, and change, the PIN code.

The PIN code can be set to protect your SIM card from unauthorised use. If set to **On**, access to your SIM card will be restricted each time it is inserted or the phone is turned on.

The option has two settings, **On** or **Off**.

 *If the SIM card does not support PIN code disabling, these items will not appear.*

OK Change SIM PIN Code

This option is used to change the SIM card PIN code.

The 'Require SIM Card PIN' option must be set to **On** and you must enter the old PIN code before you can proceed.

You will be asked to enter a new, four to eight digit code to replace the old PIN code. The new PIN code must be entered again as confirmation.

 *If the PIN number is entered incorrectly three times in a row, your SIM card will automatically lock-up and the **Blocked** message will be displayed.*

See 'Unlocking Your SIM Card' in the [Using Your Phone](#) section for details on unblocking your phone.





OK **New Security Code**

The security code is used to control access to security and other options within the menus.



This option is used to change the security code, which is set at manufacture to **000000**.

Once selected, you will be asked to enter the current security code before you can proceed.

You will then be asked to enter a new, six digit code to replace the old security code.

 *In order to safeguard your phone, you should change your security code from the factory setting as soon as possible.*

OK **Extended Menus**

 *Press and hold . Extended Menus will be temporarily activated until you exit the Options menu.*

This option is used to switch the extended menus on or off.

If the extended menu option is switched off, you will not be able to access any of the extended features.

The option has two settings, **On** or **Off**.

OK **Language Selection**

This option is used to change the language for display messages.

The option has multiple settings.

When you select a language, all further display prompts and help messages will be in the selected language.

OK **Change Greeting**

This option is used to change the message displayed when you switch on your phone.

Once selected, you will be able to enter a new greeting of up to 24 characters. The characters are entered in the same way as names, see 'How to Enter a Name' in the *Using the Phone Book Menu* section for more information.

The new greeting will be displayed when your phone is next switched on.

Battery Saving Mode

This option can help you to conserve battery power. Also know as DTX (Discontinuous Transmission), this feature will cause your phone to operate at reduced power when you are not talking.

The option has two settings, **On** or **Off**.

OK **Select Keypad Tones**

This option allows you to change or disable tones you hear when you press a key.

The option has three settings, **Normal Tones**, **Single Tone** or **No Tones**.



Phone Status

Status Review

This option can be used to view the current setting of menu options.

When selected, your phone will display a list of menu items which have been changed from the default setting. Press the  key to view the next item.

Master Reset

 *This option should be used with caution.*

This option is used to restore certain phone options to their original settings.

When selected, you will be asked to enter the security code. Once entered, the master reset option will perform the following operations:

- Cancel Automatic Answer, Audible Call Timers, Call Meter During Calls, Battery Save (DTX), Auxiliary Alert, Automatic Handsfree, Automatic Lock, Call Restrictions and Cell Broadcast.
- Return Language Selection to Original.
- Restore Keypad Tones, Ringer Tones and Volume Level to Medium.

Master Clear

 *This option should be used with extreme caution.*

This option is used to restore certain phone options to their original settings.

When selected, you will be asked to enter the security code. Once entered, the master clear option will perform the same operations as 'Master Reset', plus the following operations:

- Clear the Phone Book Entries in the Phone, Last Number Called, Voicemail Number, Home Call Cost Rates and Roam Call Cost Rates.
- Reset the Resettable Call Timers and Meters.



Network Selection Menu Items

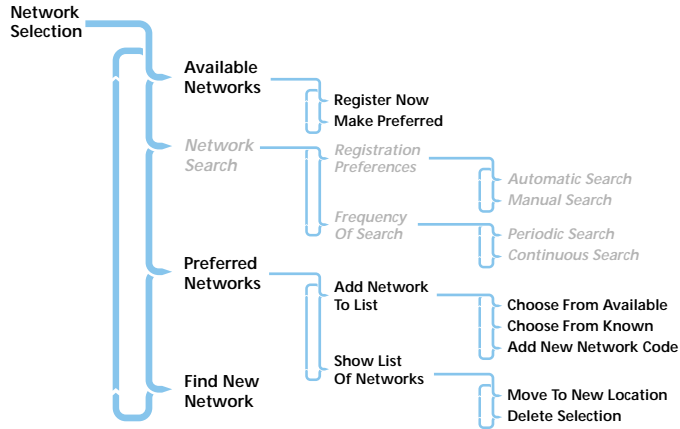

Menu Navigation



Items shown in *italics* are available only when **Extended Menu** are enabled.

The network list is sorted in the following order:

- The Home network.
- Networks from a preferred list.
- A random list of other networks found above a certain signal strength.
- All remaining networks in descending order of signal strength. Any forbidden networks, stored in the SIM card, will not be included in the sorted list.

Available Networks

When selected, this option will scan to see which networks are operating in your current location. When the scan is complete, press the **MENU** key to scroll through the list. When you see a network you wish to register with or store in your preferred list, press the **OK** key. You will now enter the 'Register Now' and 'Make Preferred' sub-menu.

Register Now

Once selected, your phone will try to register with the selected network. If the registration fails, your phone will try to register in the normal way.

Make Preferred

Once selected, you will be asked where the selected network is to be located in the preferred list.

MENU

Network Selection

In order for the phone to make and receive phone calls, it must register with one of the available networks.

Your phone automatically searches for the last network used. If, for any reason, this network is unavailable, your phone will attempt to register with a new network.

When your phone needs to register with a new network, it will generate a sorted list of networks. If no networks are found **No Service** will be displayed.



Network Search

These options determine how often your phone tries to register with a network and how the attempt is made.

Registration Preferences

This option determines how the phone tries to register with a network.

The option has two settings, **Automatic Search** or **Manual Search**.

Automatic Selection Mode

In the automatic mode, the phone will try to register with the first network in the sorted list. If this is successful, your phone will display the network name and then enter the standby mode.

If registration is unsuccessful with one network in the list, your phone will try the next listed network. If your phone fails to register with any of the listed networks, it will start at the beginning of the list after a preset period. The preset period is determined by the 'Frequency Of Search' option.

Manual Search Mode

In the manual mode, the phone will present you with the sorted list of networks. Use the **← * →**, **# →** and **OK** keys to select one network from the list. Your phone will try to register with the selected network. If this is successful, the phone will display the network name and then enter the standby mode.

If registration is unsuccessful, your phone will present the list again after a preset period. The preset period is determined by the 'Frequency Of Search' option.

Frequency Of Search

This option is used to determine how long your phone waits before attempting to re-register after a registration attempt has failed.

The option has two settings, **Periodic Search** or **Continuous Search**.

When set to periodic, your phone will wait a set time before attempting to register.

The continuous setting will cause your phone to try again immediately.

! *The continuous setting will cause heavy battery usage and should be avoided if possible.*





OK Preferred Networks

Add Network To List

This option enables you to add networks to your preferred list.

When selected, the 'Choose From Available' option will scan to see which networks are operating in your current location. When the scan is complete, press the **MENU** key to scroll through the list. When you see a network you wish to store in your preferred list, press the **OK** key. You will be asked where the selected network is to be located in the preferred list.

The 'Choose From Known' option will, when selected, present you with a preset list of networks. Press the **MENU** key to scroll through the list. When you see a network you wish to store in your preferred list, press the **OK** key. You will be asked where the selected network is to be located in the preferred list.

Select the 'Add New Network Code' option to enter network codes directly. Once entered, you will be asked where the network is to be located in the preferred list.

Show List Of Networks

This option is used to display the networks you have stored in your preferred list. In addition, pressing the **OK** key will select the currently displayed entry and enter a move/delete sub-menu.

When 'Move to New Location' is selected you will be asked to enter a new location for the selected network.

When selected, 'Delete Selection' will remove the selected network from the preferred list.

Find New Network

When selected, the phone will try to register with a network in the normal manner, with one exception. When the registration attempt is made, your current network will be excluded from the list of those available. If the attempt fails, your phone will then try to re-register with the previous network.

MENU

Call Meters Menu Items

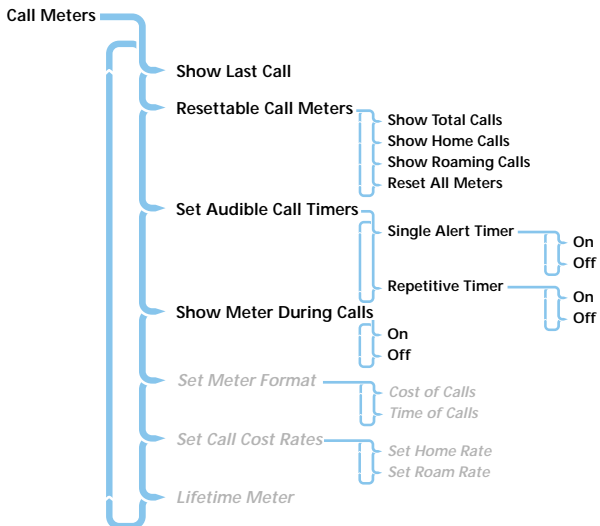

Menu Navigation



Items shown in *italics* are available only when **Extended Menus** are enabled.

Call Metering

Your phone has an internal metering system which can be used to provide you with individual and total call times or costs.

The default setting for these meters is to show call time.

If you wish to display the cost of calls, you must set the 'Set Call Cost Rates' option. This setting is then used to calculate the call costs. There are two call cost rates, home and roam, these are both required to calculate accurate costs.

The meter can be displayed during a phone call and audible tones can be generated to indicate the passage of call time.

Depending on the model, your phone will monitor either all calls or only outgoing calls.

Show Last Call

This option is used to display how long, or how much, the last call was.

Once selected, the display will show **Time** or **Cost** and the appropriate value.

The 'Set Meter Format' option is used to determine which call value is shown. The rates in the 'Set Call Cost Rates' options must be set if you wish to display the cost of a call.

Resetable Call Meters

The resettable call meters options are used to provide information on the combined length, or approximate cost, of calls made since the last meter reset. These meters can not be reset individually, all three will be reset by the 'Reset All Meters' option.



Show Total Calls

This option is used to display the total call time, or cost, since the last meter reset. The total is a combination of home calls and calls made while roaming.

Once selected, the display will show **Time** or **Cost** and the appropriate value.

The 'Set Meter Format' option is used to determine which call value is shown. The rates in the 'Set Call Cost Rates' options must be set if you wish to display the cost of a call.

Show Home Calls

This option is used to display the total call time, or cost, on your home network, since the last meter reset.

Once selected, the display will show **Time** or **Cost** and the appropriate value.

The 'Set Meter Format' option is used to determine which call value is shown. The rates in the 'Set Call Cost Rates' options must be set if you wish to display the cost of a call.

Show Roaming Calls

This option is used to display the total call time, or cost, on other networks, since the last meter reset.

Once selected, the display will show **Time** or **Cost** and the appropriate value.

The 'Set Meter Format' option is used to determine which call value is shown. The rates in the 'Set Call Cost Rates' options must be set if you wish to display the cost of a call.

Reset All Meters

This option is used to reset the resettable call meters.

OK Set Audible Call Timers

Your phone provides two programmable audible call timers:

- The 'Single Alert Timer' will sound a beep just once during a call, after a preset time has elapsed.
- The 'Repetitive Timer' will sound regular beeps during a call, at preset intervals.

In both cases, the timers will sound their beeps ten seconds before the end of the programmed time.

Single Alert Timer

This option will sound a beep just once during a call, after a preset time has elapsed.

The option has two settings, **On** or **Off**.

If you change the setting to **On**, you will be asked to enter a new preset time by using the digit keys. The preset time should be between 011 and 999 seconds.

Repetitive Timer

This option will sound regular beeps during a call, at preset intervals.

The option has two settings, **On** or **Off**.

If you change the setting to **On**, you will be asked to enter a new preset interval by using the digit keys. The preset interval should be between 011 and 999 seconds.



OK Show Meter During Calls

This option allows you to display the current call meter, during a call.

The option has two settings, **On** or **Off**.

The 'Set Meter Format' option is used to determine which call value is shown. The rates in the 'Set Call Cost Rates' options must be set if you wish to display the cost of a call.

OK Set Meter Format

This option allows you to select the way call meters are displayed.

The option has two settings, **Cost of Calls** or **Time of Calls**.

If you change the setting to **Cost of Calls**, all further meter displays will show call costs. The rates in the 'Set Call Cost Rates' options must be set if you wish to display the cost of a call.

If you change the setting to **Time of Calls**, all further meter displays will show call times.

OK Set Call Cost Rates

The rates used by your phone's call meters are programmed using this option. The rates that you enter can either be currency per minute or charge units per minute. The call cost rates for home and roaming calls should be obtained from your Cellular Service Provider.

Set Home Rate

This option is used to enter the cost of a call, per minute, on your home network.

Once selected, you will be asked to enter the rate. You should enter either the currency cost per minute or charge units per minute.

When the rate has been entered, your phone will display a confirmation message.

Set Roam Rate

This option is used to enter the cost of a call, per minute, when roaming.

Once selected, you will be asked to enter the rate. You should enter either the currency cost per minute or charge units per minute.

Lifetime Meter

This option is used to display the total time, or cost, of *all* calls made on your phone.

This meter *can not* be reset, the 'Reset All Meters', 'Master Reset' or 'Master Clear' options have no effect.

Accessory Setup Menu Items

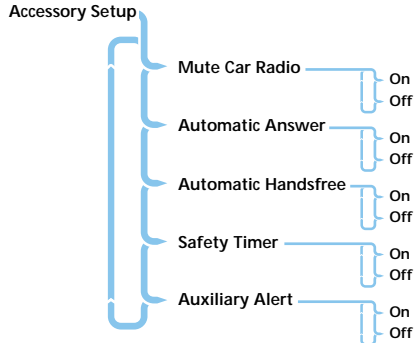

Menu Navigation



MENU

You will only be able to access this section when your phone is mounted in a car kit.

Car kits can provide charging facilities and some provide connection to an external antenna for better reception. Your phone can also be linked to external microphones and speakers for hands free operation.

Your phone provides several options to complement the use of car kits.

OK Mute Car Radio

This option can be used to mute your car radio when you make, or receive, a call when your phone is attached to the car kit.

This option has two settings, **On** or **Off**.

This option will have no effect if your car radio does not have a mute feature, or if the car kit installation does not support this option.

This option and the 'Auxiliary Alert' option are mutually exclusive. Only one of the two can be on at any time.

Automatic Answer

This option allows your phone to automatically answer an incoming call after two rings.

This option has two settings, **On** or **Off**.

If this option is **On**, we recommend that the 'Incoming Call Alert' option be set to one of the audible tones.

If you are using the Coupled Micro Car Kit, ensure that your phone is resting in the cradle.

This option will not work in conjunction with the Simple Micro Car Kit.



Automatic Handsfree

This option is used in conjunction with the 'Automatic Answer' option and a car kit, to transfer call conversation to external microphones and speakers.

This option has two settings, **On** or **Off**.

Safety Timer

This option can be used to keep the phone on for a set period after the vehicle ignition has been turned off. This prevents the vehicle's battery from becoming drained and saves you from having to re-enter PIN and Unlock codes after every short stop.

As standard the 'Safety Timer' is set to 60 minutes. Once selected, this option can be adjusted to any value between zero and 999 minutes. When set to zero, this option is effectively switched off.

Auxiliary Alert

This option allows your phone to alert you of an incoming call by flashing your vehicle lights, or by sounding the horn.

 *Some local regulations prevent the use of this option and, accordingly, this option may not be present on your phone.*

This option and the 'Mute Car Radio' option are mutually exclusive. Only one of the two can be on at any time.



MENU

The following accessories have been designed to work with your cellular phone. Additional accessories may be available and are packaged separately. Please refer to your local service provider or retail outlet for more information.

Overnight Charger (SLN5039)

The Overnight Charger allows you to charge a phone with a battery attached and a spare battery at the same time. The charging status for each battery is indicated by LEDs at the front of the charger.

 *The Overnight Charger must be used with a Transformer - SPN4026 (UK) or SPN4034 (Euro).*

Rapid Charger Base (SLN9347)

The Rapid Charger Base allows you to quickly charge a phone with a battery attached and a spare battery at the same time. The charging status for each battery is indicated by LEDs at the front of the charger.

 *The Rapid Charger Base must be used with a Transformer - SPN4026 (UK) or SPN4034 (Euro).*

Battery Saver (SKN4591)

The Battery Saver connects to your phone and allows you to power your phone from a car's cigarette lighter socket. The Battery Saver does not charge the phone's battery.

Simple Car Kit (S1759)

The Simple Car Kit allows you to safely store your phone while driving. The car kit provides power to the phone from the car's cigarette lighter socket and also charges the battery at the same time.

 *The Simple Car Kit is also available as just a Hang Up Kit and Charger without the Battery Saver (S1758).*

Simple Micro Car Kit (S3060)

The Simple Micro Car Kit allows you to safely store your phone while driving. The car kit provides power to the phone from the car's electrical system and also charges the battery at the same time.

Coupled Micro Car Kit (S3285)

The Coupled Micro Car Kit allows you to safely use your phone in your car without taking your hands off the wheel. This car kit also incorporates an external antenna and supports entertainment muting and automatic answering. The car kit provides power to the phone from the car's electrical system and also charges the battery at the same time.





Record of Phone Book Locations

Use the following table to record the names and numbers you have stored in your phone's memory; the table over page can be used to record the names and numbers you have stored in your SIM card's memory.

Location	Name	Number
1		
2		
3		
4		
5		
6		
7		
8		
9		
10		
11		
12		
13		
14		
15		
16		
17		
18		
19		
20		

Location	Name	Number
21		
22		
23		
24		
25		
26		
27		
28		
29		
30		



Location	Name	Number
101		
102		
103		
104		
105		
106		
107		
108		
109		
110		
111		
112		
113		
114		
115		
116		
117		
118		
119		
120		

Location	Name	Number
121		
122		
123		
124		
125		
126		
127		
128		
129		
130		



International Dial Codes

The following table summarises some of the more commonly used international dial codes. Remember to press and hold  before you enter the code so that the international dialling prefix + is displayed.

Country	Country Code
Australia	61
Austria	43
Bahrain	973
Belgium	32
Canada	1
Denmark	45
Egypt	20
Finland	358
France	33
Germany	49
Gibraltar	350
Greece	30
Hong Kong	852
Hungary	36
India	91
Italy	39
Japan	81
Kuwait	965
Luxembourg	352
Malta	356
Mexico	52
Monaco	33
Morocco	212

Country	Country Code
Netherlands	31
New Zealand	64
Norway	47
Poland	48
Portugal	351
Saudi Arabia	966
Singapore	65
South Africa	27
Spain	34
Sweden	46
Switzerland	41
Turkey	90
UAE	971
USA	1
UK	44





A

Accessories	55
Accessory setup menu	52
Adapter connection	12
Add entry	27
Add to phone memory	27
Add to SIM card memory	27
Adjust ring volume	42
Automatic answer	52
Automatic handsfree	53
Automatic lock	43
Automatic redial	16
Auxiliary alert	53
Available networks	46

B

Bar incoming calls	41
Bar outgoing calls	40
Batteries	
Fitting	11
Low battery warning	11
Removing	11
Battery charge level symbol	10
Battery saver	55
Battery saving mode	44
Buttons	
SIM card release	9
Volume	9

C

Call barring	40
Call cost rates	51
Call diverting	36
Call holding	38
Call metering	49
Call meters menu	49
Call number	26
Call related features menu	35
Call restrictions	41
Call timers	50
Call waiting	38
Calling a number	16
Calling an embedded number	31
Cancel all diverting	37
Capacity	
Checking	27
Cell broadcast	32
Cell broadcast messages	29
Change bar. password	41
Change greeting	44
Change SIM PIN code	43
Change unlock code	43
Characters	24
Charger indicators	12
Check capacity	27
Coupled micro car kit	55

D

Delete	
Entries from phone book	27
Desktop chargers	12
Detailed diverting	37
Dialling a phone book entry	17
Display	10
Display characters	24
Divert when unavailable	37
DTX	44

E

Embedded messages	
Returning calls	31
Emergency calls	18
Ending a phone call	19
Enter my phone number	26
Entering names	24
Erase	
Name and number	27
Extended menus	34, 44

F

Find entry by location	26
Find entry by name	25
Find new network	48
Flip	9

I

In use symbol	10
Incoming call alert	42
International dial codes	59
International phone calls	17

K

Keypad tones	44
Keys	9

L

Language selection	44
Last ten calls made/received	35
Lifetime meter	51
Lock now	43
Low battery warning	11

M

Making a phone call	16
Master clear	45
Master reset	45
Menu navigation	21
Menus	
Accessory setup menu	52
Call meters menu	49
Call related features menu	35
Extended menu	34
Messages menu	29
Network selection menu	46
Personalised menus	34
Phone Book menu	23
Phone setup menu	42
Short menu	34
Message settings	32
Messages	29
Call holding and call waiting messages	40
Calling an embedded number	31
Messages menu	29
Modify	
Name	26
Number	26
Moving around the menus	21
Mute car radio	52
Muting the phone	9

N

Names	
Entering	24
Network search	47
Network selection menu	46
Networks	
Automatic selection	47
Finding new networks	48
Manual search	47
New security code	44
No service symbol	10

O

One touch dialling	17
Overnight charger	12, 55



P

Pauses	
Inserting into phone numbers	18
Personalised menus	34
Phone book	23
Add entry	27
Call number	26
Capacity	23
Deleting/erasing entries	27
Modify name or number	26
Preventing access to	27
Storing numbers	19
<i>See also</i> Add entry	
Phone Book menu	23
Phone call	
Automatic redial	16
Dialling a phone book entry	17
Emergency calls	18
Ending	19
International calls	17
Making	16
One touch dialling	17
Receiving	19

Phone lock	43
Phone services	20
Phone setup menu	42
Phone status	45
PIN code	
Entering	15
Setting and changing	43
Point to point messages	29
Power on symbol	10
Preferred networks	48
Prevent access	27

R

Rapid charger base	12, 55
Received messages	31
Receiving a phone call	19
Record of phone book numbers	57
Redialling the last number called	17
Require SIM card PIN	43
Resettable call meters	49
Restrict	
Incoming calls	41
Keypad dialling	41
Phone number length	41
Return call	31
Ring tones	42
Ringer volume	9
Roam symbol	10

S

Safety information	5
Safety timer	53
Security code	
Changing	44
Select keypad tones	44
Set audible call timers	50
Set call cost rates	51
Set meter format	51
Short, extended and personalised menus	34
Short menu	34
Short message service symbol	10
Short Message Services (SMS)	29
Show last call	49
Show meter during calls	51
Show my phone number	26
Signal strength symbol	10
SIM card	
Insertion	14
Removal	14
Unblocking	15
SIM card PIN code	15, 43
SIM card release button	9

Simple car kit	55
Simple micro car kit	55
Status review	45
Storing phone numbers	19
<i>See also</i> Add entry	
Symbols	10

T

Timers	50
Tones	
Selecting keypad tones	44
Setting alert tones	42

U

Unblocking your SIM card	15
Understanding this manual	4
Unlock code	
Entering	15
Setting and changing	43
Useful information	57

V

Voicemail number	32
Volume	
Adjusting the earpiece volume	9
Adjusting the keypad tone volume	9
Adjusting the ring volume	9, 42
Buttons	9