

Contents

Getting Started	3	Using Two Voice Lines	48
Making and Receiving Calls	8	Calling Card Calls	49
Key Functions	12	Setting Network Preferences	50
Using the Menus	13	Fax and Data Calls	52
Entering Letters	17	Extras	53
Your Personal Phone Book	18	Online Services	61
Using the Call List	23	Ericsson Mobile Internet	62
Your Voice Mail Service	24	Changing Covers	63
Personalizing Your Phone	25	Troubleshooting	64
Text Messages (SMS)	31	Display Icons	66
Profiles	36	Quick Keys	67
Voice Control	37	Technical Data	68
Diverting Incoming Calls	39	Guidelines for Safe and Efficient Use	69
Handling More Than One Call		Warranty	74
Simultaneously	40	Declaration of Conformity	75
Call Time and Call Cost	43	Index	77
Security for Your Phone and			
Subscription	44		

Ericsson A2618s

First edition (April 2000)

This manual is published by Ericsson Mobile Communications AB, without any warranty. Improvements and changes to this manual necessitated by typographical errors, inaccuracies of current information, or improvements to programs and/or equipment, may be made by Ericsson Mobile Communications AB at any time and without notice. Such changes will, however, be incorporated into new editions of this manual.

All rights reserved.

©Ericsson Mobile Communications AB, 2000

Publication number: EN/LZT 108 3563 R1A

INNOVATRON PATENTS

Please note:

Some of the services in this manual are not supported by all networks. *This also applies to the GSM International Emergency Number 112.*

Please contact your network operator or service provider if you are in doubt whether you can use a particular service or not.

Note! You should read the “Guidelines for Safe and Efficient Use” and the “Warranty” chapters before using your mobile phone.

WAP™, W@P™ and WAP Forum™ are registered trademarks of the WAP Forum, LTD., a registered company in the United Kingdom.

Getting Started

Front

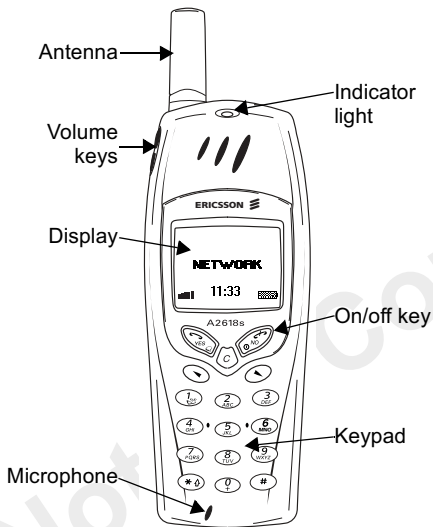

Back

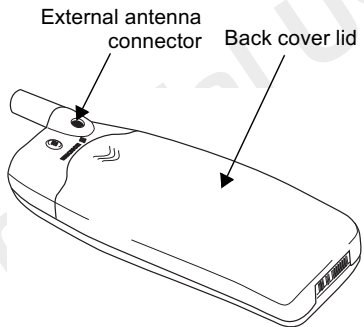

About this User's Guide

Some services and functions described in this User's Guide are network- and subscription-dependent. Because of this, all menus may not be available in your phone and the shortcut numbers to menus and functions may vary between phones.

This symbol indicates that a service or function is network- or operator-dependent.



Please refer to the information provided by your network operator for more information about your subscription.

We recommend that you read the chapter “Using the Menus” on page 13 for information about how to move through the menus.

The SIM Card

When you register as a subscriber with a network operator, you get a SIM (Subscriber Identity Module) card. The SIM card contains a computer chip that keeps track of your phone number, the services included in your subscription, and your Phone Book information, among other things.

SIM cards come in two sizes. One is the size of a credit card and the other is smaller. Your phone uses the smaller card. Many credit card-sized SIM cards

have a perforated smaller card that you can take out easily.

Assembly

Before you can use your phone you need to:

- insert the SIM card.
- attach and charge the battery.

Note: *Always turn off the phone and detach the charger before you insert or remove a SIM card.*

Inserting the SIM Card

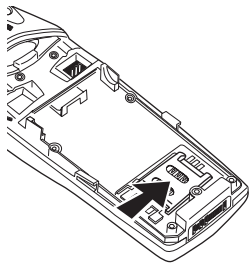

1. Release the SIM card holder by pressing it in the direction of the arrow.

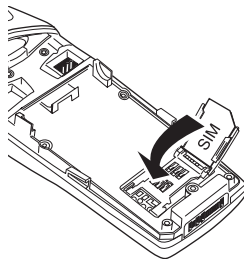

3. Press down the holder.

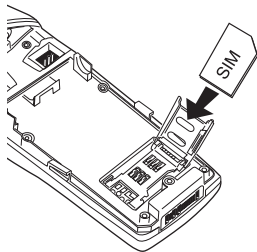

2. Open the holder. Slide the SIM card into the holder. Make sure that the cut corner is top right.

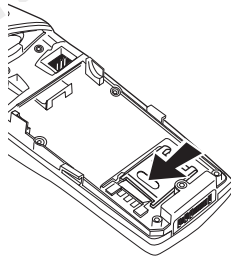

4. Lock the holder by sliding it in the direction of the arrow.

Attaching the Battery to your Phone

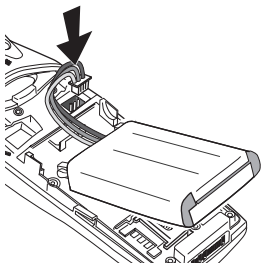

1. Insert the battery plug into the socket as shown in the picture.

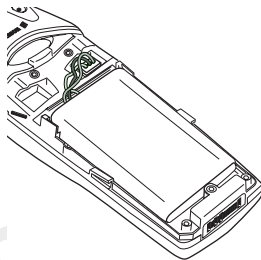

3. Press the battery down flat. Make sure that the battery wires do not get caught under the battery.

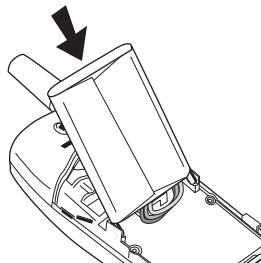

2. Slot the battery into the metal holders as shown in the picture.

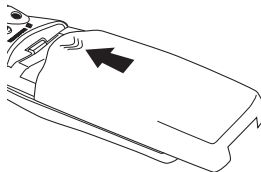

4. Place the back cover as shown in the picture and slide it into place.

The Battery

Your phone comes with a lithium or NiMH battery. We recommend that you charge the battery for 4 hours, if you are using the lithium battery, and for 7 hours, if you are using the NiMH battery, before you use the phone for the first time.

When to Charge the Battery

The battery can be charged whenever you wish without affecting its performance. To remind you that you need to charge the battery:

- an alarm signal (a short beep) sounds and *Attention! Battery low* appears in the display.

Charging the Battery

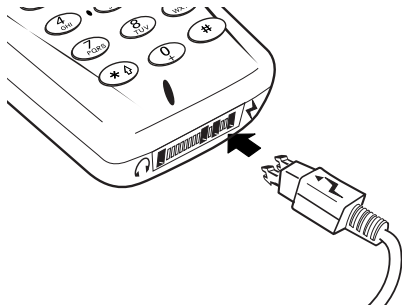

1. Make sure that the battery is attached to the phone.
2. Connect the charger to the phone at the flash symbol as shown in the picture. The flash symbol on the charger plug must face upwards.
3. Connect the charger to the mains.

To indicate charging:

- the battery meter in the display pulses continuously
- if the phone is on, the indicator on top of the phone shows a steady green light.

Note: *If you charge a new battery, or one that has not been used for a long time, it may take a while before you get an indication of charging in the display.*

You can use the phone while the battery is being charged. However, this lengthens the charging time. When the battery is fully charged, the battery meter in the display is full.

Disconnecting the Charger

- Disconnect the charger from the phone by tilting the plug upwards.

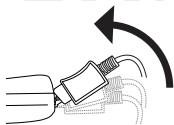

Making and Receiving Calls

Before you can make and receive calls, you need to turn on the phone and be within range of a network.

Turning Your Phone On

- Press and hold the **no** key until you hear a tone.

Some SIM cards are protected with a PIN (Personal Identity Number).

If *PIN:* appears in the display after you have turned on the phone:

1. Enter your PIN.

If you make a mistake while entering your PIN, delete the wrong number by pressing the **c** key.

2. Press **YES**.



Note: *Your PIN is provided by your network operator.*

Network Search

After you have turned on the phone (and entered your PIN), the phone searches for a network. When a network is found, the phone beeps three times. The

indicator light on top of the phone flashes green and your network operator's name appears in the display.

This is called "standby mode". You can now make and receive calls.

Note: *If you do not reach standby, see "Error Messages" on page 64.*

Making a Call

1. Enter the area code and phone number.
2. Press **YES**.

Ending a Call

- Press **NO** to end the call.

Changing the Earpiece Volume

During a call you can change the listening volume by pressing the volume keys on the side of the phone.

- Press the upper key to increase the volume.
- Press the lower key to decrease the volume.

Turning Off the Microphone

During a call you can turn off the microphone.

- Press the **c** key for a few seconds to turn off the microphone.

- Press and hold **c** again to resume the conversation.



Turning Your Phone Off

- In standby mode, press and hold the **NO** key until you hear a tone. To go to standby mode, press and hold **NO**.

Re-dialling a Previously Called Number

In the *Call List* you can find the numbers that you have dialled, answered or missed.

To re-dial a previously called number

1. Press **YES** from standby mode to enter the *Call List*.
2. Press  or  to scroll through the list.
3. When the number you want to call is highlighted, press **YES** to make the call.
See "Using the Call List" on page 23.

Automatic Re-Dialling

If a connection failed, and the display shows *Retry?*, you can re-dial the number by pressing the **YES** key. Your phone automatically re-dials (up to 10 times):

- until the call is answered.
- until you press a key or receive a call.

Note: *Automatic re-dialling is not available for fax and data calls*

Making International Calls

1. Press and hold the **0** key until a + sign appears. The + replaces the international prefix number of the country from which you are calling.
2. Enter the country code, area code (without the leading zero) and phone number.
3. Press **YES**.

Making Emergency Calls

1. Enter **112** (the international emergency number).
2. Press **YES**.





Your Ericsson phone supports the international emergency number 112. This means that it can normally be used to initiate an emergency call in any country, with or without a SIM card inserted, if a GSM network is within range.

Note: *Some network operators may require that a SIM card is inserted, and in some cases that the PIN has been entered as well.*

Emergency Numbers

Some countries may not promote the international emergency number, 112. Your operator may therefore have stored additional local emergency numbers on the SIM card, which work in addition to the international emergency number. 

To use another emergency number

1. Press  to go to the *Phone Book* menu.
2. Press **YES** to select the menu.
3. Press  until *SOS Number* is highlighted, then press **YES**.
4. Press  or  to go to the number you want, then press **YES** to make the call.

Receiving Calls

When you receive a call, the phone rings and the display shows *Answer?*.

If your subscription includes the Calling Line Identification (CLI) service and the caller's network sends the number, the caller's number is shown in the display. If you have saved the caller's name and number in the phone book, the caller's name is

displayed. If the network does not send the number, the display shows *Withheld*.

Answering a Call

- Press **YES** to answer a call.

Rejecting a Call

- Press **NO**, or
- double click either of the volume keys on the side of the phone to reject a call.

The caller hears a busy tone if this is supported by the caller's network. If *Divert Calls When Busy* is on, the call is diverted to the number you have specified. See "Diverting Incoming Calls" on page 39.

The Notepad

If you want to make a note of a phone number during a call, you can use your phone display as a notepad.

Use the number keys to enter the number. When you end the call, the number remains in the display.

When you enter the number, the person at the other end can hear the tones. You can turn the tones off (can only be done during a call).



To turn the tone signals off during a call

1. Press  until the *Ongoing Call* menu appears.
2. Press **YES** to select the menu.
3. Press **YES** again to turn off the tone signals.

Showing And Hiding Your Phone Number

You can choose to show or hide your number for a particular call, if this service is supported by your subscription.

To hide or show your phone number

1. Enter the phone number you wish to call.
2. Press  until the *Call Info* menu appears.
3. Press **YES** to select the menu.
4. Press  again until *Next Call* is highlighted.
5. Press **YES** to select *Next Call*.
6. Select *Hide My Number* or *Show MyNumber* and press **YES** to make the call.



Ciphering

Ciphering is a built-in feature that scrambles your calls and messages to provide additional privacy.

An exclamation mark inside a triangle is shown in the display during a call to indicate that ciphering is currently not being provided by the network.

Key Functions



The table below shows some examples of the key functions. See also “Quick Keys” on page 67.

Key	Use
YES	To make calls and answer calls. To select a menu or setting.
NO	To turn the phone on or off, press and hold the key. To end a call. To reject a call. To go back one level in the menus, to leave a setting unchanged. To go back to standby mode, press and hold NO .
 and 	To move (scroll) through menus, lists and text.
c (Clear)	To delete numbers and letters from the display. To delete an item from a list. To turn off the microphone during a call, press and hold the key.

Key	Use
1–9, 0	To enter the digits 0-9. Press and hold 0 to enter the international prefix +. To enter letters. To move through menus using shortcuts.
*	To enter *.
# (Hash)	To enter #.
Volume keys	To increase or decrease the volume of the earpiece or handsfree loudspeaker during a call. To reject an incoming call, press either of the keys twice. To scroll through menus, lists and text. To enter the Status menu.



Using the Menus

There are seven main menus. Each menu has several sub-menus, where you find the different functions.



You move through the menus by pressing the  and  keys, or by using shortcuts. You move from left to right in the main menu and up and down in the sub-menus.

Moving Through the Menu



There are two ways of moving through the menus:

- Scrolling with the  and  keys
- Using shortcuts

Scrolling by Using  or 

Press...	to...
	scroll left or up through the menus.
	scroll right or down through the menus.
YES	select a menu, sub-menu or an option.
NO	go back one level in the menus, leave an option unchanged. press and hold NO to go back to standby.

Using Shortcuts

A quicker way to move through the menus is to use shortcuts. Enter the menu by pressing  or  and then simply enter the number of the menu to which you want to go. To get back to standby, press and hold **NO**.



How to Interpret the Instructions

In this example of how to interpret the instructions, we are going to set the key sound to the tone option.

To set the key sound

1. Scroll to *Settings*, **YES**, *Sounds & Alerts*, **YES**, *Key Sound*, **YES**.
2. Select *Tone* and press **YES**.

Interpret the instructions as follows:

1. From standby, press  or  to scroll to the *Settings* menu.





2. Press **YES** to select the *Settings* menu. The name of the menu that you have chosen is shown at the top of the display (*Settings*).





A flashing arrow in the right part of the display indicates that more menus are available.

3. Press **YES** to select the *Sounds & Alerts* sub-menu. (You do not need to scroll with the arrow keys as this is the first sub-menu.)

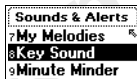
4. Press  or  to scroll to the *Key Sound* sub-menu and press **YES** to select it.



5. Press  or  to scroll to the *Tone* option and press **YES** to select it. You have now set the key sound to tones.







6. Press and hold **NO** to go back to standby.

Shortcuts

This is how to interpret the instructions above by using shortcuts:

To set the key sound

1. Press  or  to enter the main menu.
2. Press **4** to select the *Settings* menu.
3. Press **1** to select the *Sounds & Alerts* sub-menu.
4. Press **8** to select the *Key Sound* sub-menu.
5. Press  or  to scroll to *Tone*.
6. Press **YES** to select the *Tone* option.
7. To go back to standby, press and hold **NO**.

Tip: To check a setting without changing it: scroll to the setting and leave it unchanged by pressing **NO**.

Display text

- Text at the top indicates the menu you have chosen.
- A text that is highlighted shows your position in the menu. If you press **YES**, you enter this menu or select this option.

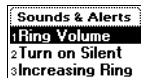

- Grey text indicates a function that is temporarily unavailable, for example due to your subscription or due to a certain setting which has not been turned on.
- A filled button indicates that this option is selected.
- A tick indicates that this item is selected.



Display Language

Most SIM cards automatically set the display language to the language of the country where you bought your SIM card, *Automatic*. If this is not the case, the preset language is English.

To change the display language

1. Scroll to *Settings*, **YES**, *Language*, **YES**, *Menus*, **YES**.
2. Select a language and press **YES**.

Note: You can always choose *Automatic* by pressing

◂ 8888 ◃ in standby.

You can always choose *English* by pressing ◂

0000 ◃ in standby.

Help Texts

To help you use the menus and functions, your phone has pop-up help texts that explain the menus.

These help texts are set to *On* when you buy your phone, but you can turn them off at any time.

To turn the help texts on or off

1. Scroll to *Settings*, **YES**, *Display*, **YES**, *Menu Help*, **YES**.
2. Select *On* or *Off* and press **YES**.

Menu overview

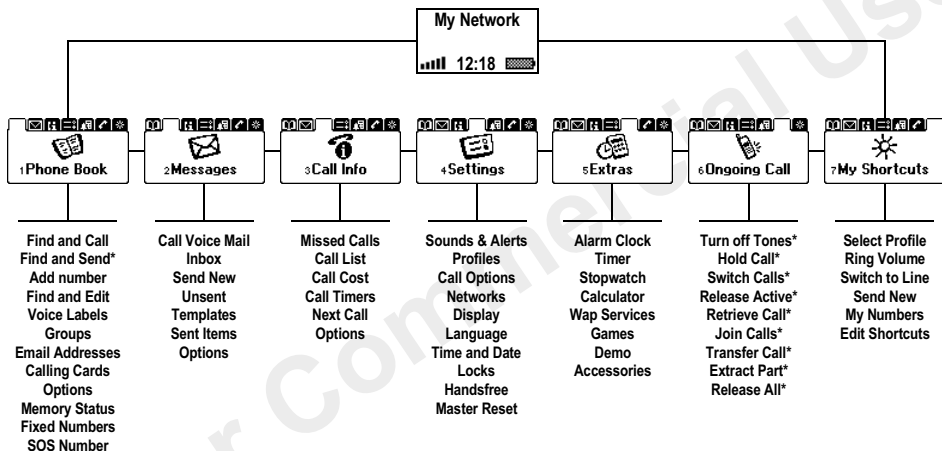

Please note that some menus are network- and subscription-dependent.
* Only available during a call.

Entering Letters

You can enter letters when you add names to the phone book, write text messages (SMS) or enter WAP addresses. Press the appropriate key, **1–9, 0** or **#**, repeatedly until the character you want appears in the display.

Press...	to get...
1	Space - ? ! , . : ; " ' < = > () _ 1
2	A B C Ä Å Æ à ç 2 Γ
3	D E F è é 3 Δ Φ
4	G H I ì 4
5	J K L 5 Λ
6	M N O Ñ Ö Ø ò 6
7	P Q R S ß 7 Π Σ
8	T U V Ü ù 8
9	W X Y Z 9
0	+ & @ / □ % \$ £ ¥ § ¨ ¡ 0 Θ Ξ Ψ Ω
#	# * ␣

Example:

- To enter an 'A', press **2** once.
- To enter a 'B', quickly press **2** twice.
- To enter lower-case letters, enter the letter, for example an 'A' and then press *****. Lower-case letters appear until you press ***** again.
- To enter numbers, press and hold any numeric key.
- To delete letters and numbers, press **c**.

Choosing alphabet(s)

You can choose which alphabet(s) (input methods) you want to use. When you are writing messages, entering names or WAP addresses, you can switch to another alphabet by pressing **#**. First you need to set the alphabets you want to choose from.

To choose an alphabet

1. Scroll to *Settings*, **YES**, *Language*, **YES**, *Input*, **YES**.
2. Use ***** to select the alphabets (input methods) you want to choose from or to cancel the selection.
3. Press **YES** to leave the menu.

Your Personal Phone Book

Your phone has a phone book in which you can save numbers and accompanying names (an entry).

This means that you can recall a number from the phone book instead of entering the number again.

Your phone also supports voice dialling which means that you can add a voice label to a phone book entry and then call that entry by simply saying the name. See “Voice Control” on page 37.

Saving a Number Together with a Name

When you want to save a phone number, you use the *Add Number* function in the Phone Book menu. If you have already made and received calls, you can find these numbers in the Add Number list.

Every phone number you save also gets a position number. If you want to, you can choose to sort your phone book entries according to their position number instead of the name.

If you intend to use your phone both at home and abroad, it is a good idea to save all phone numbers as international phone numbers, i.e. with the + sign, followed by the country code, the area code and the phone number. Press and hold **0** to enter the + sign.



To save a number together with a name

1. Scroll to *Phone Book*, **YES**, *Add Number*, **YES**.
2. Select *Add new?* or any of the numbers from the list by pressing **YES**.
3. Enter the phone number that you want to save and press **YES**.
4. Enter a name that you want to associate with the phone number and press **YES**.
See “Entering Letters” on page 17.
5. Press **YES** again to save the entry in the suggested position.
6. When voice dialling is on, you are asked if you want to record a voice label for your entry. Press **YES** if you want to record a voice label, press **NO** if you do not. You can always add a voice label later. See “Voice Control” on page 37 for more information.

Calling a Number Saved in the Phone Book

You use the *Find and Call* function to call a number that you have saved in the phone book.

To call a number saved in the phone book

1. Press and hold  until the *Find and Call* menu appears.
2. Enter the name (or the first few letters of the name) associated with the number that you want to call and press **YES**.
If the name displayed is not the one you want, press  or  until you find the correct name and number.
3. Press **YES** to make the call.

Shortcuts to Phone Book Entries

You can call the phone numbers that you have saved in positions 1–9 by entering the position number in standby, and then pressing **YES**.

Example:

- Press **3** and then **YES**.

When in standby, you can find an entry by pressing and holding one of the keys **2–9** to find an entry beginning with the first letter on that key, or the closest following.

Example

- Press and hold **4** to get to the first entry beginning with the letter ‘G’ (or the closest following). Press **4** again to get to the first entry beginning with ‘H’ and so on. When you find the entry you want, press **YES** to make the call.

Ask to Save

If Ask to Save is on, you are asked if you want to save any called or answered number that is not already saved in your phone book.

To turn the Ask to Save function on or off

1. Scroll to *Phone Book*, **YES**, *Options*, **YES**, *Ask to Save*, **YES**.
2. Select *On* or *Off* and press **YES**.

Note: *Your subscription must support the Calling Line Identification Service, if you want to save answered numbers.*

Keeping the Phone Book Up to Date

You can change and delete names and numbers from the phone book.

To edit an entry

1. Scroll to *Phone book*, **YES**, *Find and Edit*, **YES**.
2. Enter the name (or the first few letters) for the entry that you wish to edit and press **YES**.
3. Press **YES** to select the entry.
4. Select *Edit* and press **YES**.
5. When you have finished editing, press **YES** to save your changes.

To delete an entry from the phone book

1. Scroll to *Phone book*, **YES**, *Find and Edit*, **YES**.
2. Enter the name (or the first few letters) for the entry that you wish to edit and press **YES**.
3. When the entry you want to delete is highlighted, press **C**.
4. Press **YES** to confirm.

Sort Order

You may change the sort order of your phone book entries, so that they are sorted according to their position number instead of the name. This means that you search for the position number when you use the Find and Call or the Find and Edit functions.

To choose a sort order

1. Scroll to *Phone Book*, **YES**, *Options*, **YES**, *Sort Order*, **YES**.
2. Select a sort order and press **YES**.

Phone Book Memories

Your phone book entries are saved in the memory on your SIM card. The number of entries you can save depends on your SIM card. By saving your entries on the SIM card, you still have access to them if you use the card with another phone.

You can also save your entries in the phone memory. The phone memory holds 100 positions in which your entries are saved when all SIM positions are occupied. If you save your entries in the phone memory, you still have access to them if you use another SIM card with your phone.

Choosing where to save an entry

When you save an entry and are asked to enter the position number, you can do the following:

- To save the number in the first empty position suggested, press **YES**.

- To save the number in another position, press **c** to delete the position number, enter a new position number and press **YES**.
- To save the number in the phone memory, you first need to know how many positions you have got on your SIM card. You can check this in the *Memory Status* menu. If, for example, you have 200 positions on your SIM card, you can enter position number 201 to save a number in the first position of the phone memory.

Overwrite Protection

If you try to save a phone number in a position which already contains a phone number, the message *Overwrite?* appears together with the name saved in that position. You now have two options:

- Press **YES** to replace the number with the new one.
- Press **NO** if you do not want to replace the old number. Enter a new position and press **YES**.

Checking the Status of the Memory

You can check how many memory positions you have in your memories and how many of them you have used.

To check the status of the memories

- Scroll to *Phone Book*, **YES**, *Memory Status*, **YES**.

If you have saved entries in the phone memory, you can delete them.

To delete all entries from the phone memory

1. Scroll to *Phone Book*, **YES**, *Delete All*, **YES**.
2. Press **YES** again.
3. Enter the phone lock code (0000 or another one that you have chosen yourself, see “The Phone Lock” on page 45), and press **YES**.

Note: *The entries on your SIM card are not deleted.*

Groups

You can create a group of phone book entries. You can then send a text message to all members of that group at the same time. See “Text Messages (SMS)” on page 31.

To create a new group

1. Scroll to *Phone Book*, **YES**, *Groups*, **YES**, *Add new?*, **YES**.
2. Enter a name for the group and press **YES**.

3. Scroll to *Add new?* and press **YES**.
4. Select an entry in your phone book and press **YES**.
5. To add the next member, repeat steps 3 and 4.
6. Press **NO** to leave the menu.

To add a member to an existing group.

- Select the group you want and then select *Edit/Add new?*

Copying From One SIM Card to Another

You can copy your phone book entries on one SIM card to another, via the phone's memory.

If your phone memory contains phone book entries that you wish to keep, you first need to copy these entries from the phone memory to a SIM card, otherwise they will be deleted.

Note: *You can only copy 100 items at a time. Check your phone memory and your SIM card memory before you start copying, to make sure that you do not delete entries you want to keep.*

Note: *Always turn off the phone and detach the charger before you insert or remove a SIM card.*

To copy from a SIM card to the phone memory

1. Insert a SIM card.
2. Scroll to *Phone Book*, **YES**, *Options*, **YES**, *Copy*, **YES**, *Copy from Card*, **YES**.
3. Enter from which position number on the SIM card you want to start copying and press **YES**.
4. Press **YES** again to start copying.
Wait until the display shows *Phone book entries copied*.

To copy from the phone memory to a SIM card

1. Insert a SIM card.
2. Scroll to *Phone Book*, **YES**, *Options*, **YES**, *Copy*, **YES**, *Copy to card*, **YES**.
3. Enter the position number of your SIM card where you want to start saving your entries and press **YES**.
For example, if you have 10 entries on the SIM card that you want to keep, select position 11.
4. Press **YES** again to start copying.
Wait until the display shows *Phone book entries copied*.

Using the Call List

The Call List is a phone number log that saves information (time, date, phone number and name) about the last 20 dialled, answered and missed calls. Once your list exceeds 20 calls, the oldest one is deleted.

The calls are saved in chronological order, except for the last dialled number, which is always displayed in the first position. If you check a call within 24 hours, the time of the call is displayed. Otherwise, the time is replaced by the date.

If the incoming call is a restricted number, the display shows *Withheld*.

To call a number from the call list

1. Press **YES** when the phone is in standby mode.
2. Select the number you want to call and press **YES**.

Tip: You can also select the Call list from the Call Info menu.

You can clear the call list.

- Select *Clear Call List* from the *Call Info/Options* menu.

To turn the call list on or off

1. Scroll to *Call Info, YES, Options, YES, Set Call List, YES*.
2. Select *On* or *Off* and press **YES**.
If you turn off the list, it is cleared.

Missed Calls

If you have missed a call, the message *Missed Calls:1* appears in standby mode. (The number indicates the number of missed calls.)

To check your missed calls

1. Press **YES**.
2. If you wish to call a number from the list, select the number and press **YES**.

Press **NO** if you do not want to check your missed calls now. You can always check them later.

- Select *Missed Calls* from the *Call Info* menu.

Your Voice Mail Service

The answering service of your network operator allows callers to leave a voice message when you cannot answer your calls. Depending on your operator, you are informed that someone has left a message in different ways.



Most operators send a text message (SMS), asking you to call your voice mail service, for example. See “Text Messages (SMS)” on page 31 for more information.

Other operators send a specific voice mail indication. If this is the case, the voice mail icon appears in the display.

Using Your Voice Mail Service

You can save the number to your voice mail service, making it easier for you to call your voice mail.

To save your Voice Mail number

1. Scroll to *Messages*, **YES**, *Options*, **YES**, *Voice Mail No.*, **YES**.
2. Enter your Voice Mail number and press **YES**.

- To call your Voice Mail Service*
- Press and hold **1** from standby.

You can also select Call Voice Mail from the Messages menu.

Receiving a Voice Mail

When you receive a voice mail, your phone beeps and the message *New Voice Mail* appears in the display.

- Press **YES** to listen to the voice mail. If you want to listen to it later, press **NO**.

Personalizing Your Phone

You can adjust the phone settings to suit your own requirements.



Ring Signals

You can specify the ring signal volume, choose among different ring signals or compose your own ring signals.

Ring Signal Volume

The ring signal volume can be set to six levels. You can also turn the ring signal off (0).

To set the ring signal volume

1. Scroll to *Settings*, **YES**, *Sounds & Alerts*, **YES**, *Ring Volume*, **YES**.
2. Press  or  to increase or decrease the volume.
3. Press **YES** to save the setting.

Tip: Use the volume keys on the side of the phone to change the volume silently.

To turn the ring signal on or off

1. From standby, press and hold **c**.
2. Select *Turn on Silent* and press **YES**.
All signals except the alarm and timer signals are turned off.
To cancel, repeat step 1, select *Turn off Silent* and press **YES**.

Increasing Ring

You can choose a ring signal that rises in steps from the lowest volume to the highest.

To turn the increasing ring on or off

1. Scroll to *Settings*, **YES**, *Sounds & Alerts*, **YES**, *Increasing Ring*, **YES**.
2. Select *On* or *Off* and press **YES**.

Ring Signal Type

You can choose a ring signal from a list of different sounds and melodies.

To choose a ring signal

1. Scroll to *Settings*, **YES**, *Sounds & Alerts*, **YES**, *Ring Signals*, **YES**, *Voice Calls*, **YES**.
2. Select a ring signal and press **YES**.

Tip: Use the volume keys on the side of the phone to scroll silently.

Tip: If you subscribe to the 'Two Line Service', you can set different ring signals for the two lines. If your SIM subscription supports fax and data calls, you can set different ring signals for these too.

Specific Ring Signals for Personal Calls

If your subscription includes the Calling Line Identification (CLI) service, you can assign a personal ring signal to up to ten callers.

If the last seven digits of a caller's number correspond to a number you have specified, then that caller's ring signal is used.

You can include question marks in a phone number. For example, 012345??? means that calls from phone numbers between 012345000 and 012345999 will have the same personal ring signal. Press and hold # to insert a question mark.

To set a specific ring signal for a caller

1. Scroll to *Settings*, **YES**, *Sounds & Alerts*, **YES**, *Ring Signals*, **YES**, *Personal Rings*, **YES**, *Add new?*, **YES**.
2. Enter the caller's number and press **YES**. Press  to recall a number from the phone book.
3. Select a ring signal and press **YES**.

Composing Your Own Ring Signal

You can compose four different ring signals.

To compose or edit a ring signal

1. Scroll to *Settings*, **YES**, *Sounds & Alerts*, **YES**, *My Melodies*, **YES**.
2. Select one of the melodies and press **YES**.
3. Press **c** to remove notes.
4. Use the keypad to enter notes:
 - Press and hold a key to enter a long note.
 - Press **0** to raise the note one octave.
 - Press **#** once to raise the note one semitone.
 - Press **#** twice to lower the note one semitone.

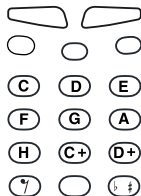

- To listen to your melody, press **YES**.
- Press **YES** again to save it or press **NO** to continue composing.

Message Signal

You can set the message signal to clicks, tones or silent.

- Select *Message Alert* from the *Settings/Sounds & Alerts* menu and then select the signal you want.

Key Sound

You can set the key sound to clicks, tones or silent.

- Select *Key Sound* from the *Settings/Sounds & Alerts* menu and then select the key sound you want.

Minute Minder

If you turn on the minute minder, you hear a beep once every minute during a call.

- Select *Minute Minder* from the *Call Info/Call Timers* menu and then select *On* or *Off*.

Display Light

The display light can be set to automatic, off or on. In automatic mode, the display light is turned off a few seconds after you press the last key.

- Select *Light* from the *Settings/Display* menu, and then select the alternative you want.

The Keypad Lock

The keypad lock feature helps you to avoid accidental dialling, which may happen if you keep your phone in your pocket.

Note: *Calls to the international emergency number 112 can still be made, even when the keypad is locked.*

The keypad remains locked until you:

- answer an incoming call
- unlock the keypad

To lock the keypad manually

- Press and hold **c**.
- Select *Turn on Keylock* and press **YES**.

The Automatic Keylock

Automatic keylock means that if no keys are pressed after 25 seconds, the keypad will be locked.

To turn the automatic keylock on or off

1. Scroll to *Settings*, **YES**, *Locks*, **YES**, *Auto Keylock*, **YES**.
2. Select *On* or *Off* and press **YES**.

To unlock the keypad

1. Press and hold **c**.
2. Select *Turn off Keylock?* and press **YES**.

Note: *The keypad lock is always off if the phone is connected to vehicle handsfree equipment.*

My Shortcuts

You can place your favourite functions in the menu *My Shortcuts*. In this way, you can quickly and easily reach the functions you use most. When you buy your phone, *My Shortcuts* contains a few functions which you can remove if you wish.

To add a function to My Shortcuts

1. Scroll to *My Shortcuts*, **YES**, *Edit Shortcuts*, **YES**.
2. Select a function from the list by pressing *****.
3. Enter the position number you want for your function in this menu and press **YES**.

To add another function, repeat steps 2 and 3.

To remove a function, repeat steps 1 and 2.

4. Press **YES** to exit the list.

Tip: *Press and hold  to reach the first sub-menu in the menu My Shortcuts.*

Time and Date

The time is always displayed in standby mode.

To set the clock

1. Scroll to *Settings*, **YES**, *Time and Date*, **YES**, *Set Time*, **YES**.
2. Enter the time and press **YES**.
If you select the 12-hour clock, you can alternate between am and pm by pressing **#**.

You can choose a 12-hour or a 24-hour clock.

- Select *Time Format* from the *Settings/Time and Date* menu, then select the time format you want.

Automatic Time Zone

If you turn on the *Automatic Time Zone* function, you will be asked if you want to set the clock when you enter a new time zone.



- Select *Automatic Time Zone* from the *Settings/Time and Date* menu.

Date

When the phone is in standby mode, you can press either of the volume keys to see today's date.

To set the date

1. Scroll to *Settings, YES, Time and Date, YES, Set Date, YES*.
2. Enter the year (two digits), month and day and then press **YES**.

You can select another date format.

- Select *Date Format* from the *Settings/Time and Date* menu, then select the date format you want.

Answering Mode

When using a portable or vehicle handsfree unit, you can choose to answer a call by pressing any key

(except the **NO** key) or set the phone to answer the call automatically.

To select answering mode

1. Scroll to *Settings, YES, Handsfree, YES, Answering Mode, YES*.
2. Select an answering mode and press **YES**.

Tip: You can also answer a call by using the voice answering function. See "Voice Answering" on page 38.

Start Up/Shut Down Show

When you turn your phone on or off, the Ericsson start up/shut down show appears in the display. Your operator's own greeting may be shown instead.

If you want to interrupt the start up show, you can press the **NO** key.

To select a start up/shut down show

1. Scroll to *Settings, YES, Display, YES, User Greeting, YES*.
2. Select a show and press **YES**.

You can also turn off the start up/shut down show by selecting *Off*.

To turn the start up melody on or off

1. Scroll to *Settings*, **YES**, *Display*, **YES**, *User Greeting*, **YES**.
2. Select a show and press **YES**.
3. Select *Animation sound*, **YES**, *On* or *Off*, **YES**.

My Animation

By purchasing the Ericsson infrared modem, DI 28, you can create and download your own start up show (provided you have a PC). You can also compose or download a melody and set this as your start up melody. From your phone, you can set the transition of your animation, for example if you want it to “box out” etc.

- Select *My Animation* from the *Settings/Display/User Greeting* menu and then select the transition you want.

Demo

You can run a demo which shows the phone’s main menus.

- Select *Demo* from the *Extras* menu.
- Press **NO** when you want to end the demo.

Phone Number Display

You can check your own phone number(s).

- Select *My Numbers* from the *Settings/Display* menu. If your number is not stored on your SIM card, you can enter it yourself.

Master Reset

You can reset the phone settings to the way they were when you bought your phone.

To reset the phone

1. Scroll to *Settings*, **YES**, *Master Reset*, **YES**.
2. Enter the phone lock code (*0000* or the new code if you have changed it) and press **YES**.

Text Messages (SMS)

You can use the Short Message Service (SMS) to send and receive text messages consisting of up to 160 characters.



If the number to your service centre is not stored on your SIM card, you must specify the number yourself. Otherwise you cannot reply to received messages or send your own messages.

To check the number to your service centre

1. Scroll to *Messages*, **YES**, *Options*, **YES**, *Service Centres*, **YES**.

If no number is found, select *Add new?* and press **YES**.

2. Enter the number, including the international + sign and country code, and press **YES**.

Note: *The number to your service centre is provided by your operator.*

To send a text message

1. Scroll to *Messages*, **YES**, *Send New*, **YES**.
2. Enter your message and press **YES**.
See “Entering Letters” on page 17.

3. Enter the recipient’s phone number or recall it from the phone book by pressing .
4. Press **YES** to send the message.

If you want to send the message later, press **NO** when you are asked to enter the phone number. The message is saved in the *Unsent* list in the *Message* menu.

Sending a Text Message to a Group

You can send text messages to group that you have specified and saved in your phone book, see “Groups” on page 21.

To send a text message to a group

1. Scroll to *Messages*, **YES**, *Send New*, **YES**.
2. Enter your message and press **YES**.
3. Press , select *Groups* and press **YES**.
4. Select a group and press **YES**.

Note: *You will be charged for each group member.*

Customizing Your Text Messages

Before you send a message, you can set the “type of message”, the “validity period” and whether you want the recipient of your message to reply.

You can set a standard option or turn on “set on send”, which means that you make your choices each time you send a message.

Message Type

You can send different types of messages. Your network operator’s service centre may offer the facility of converting a text message into a format (e-mail, fax, etc.) that suits the equipment that is going to receive the message.

To select a message type

1. Scroll to *Messages*, **YES**, *Options*, **YES**, *Message Type*, **YES**, *Set Default*, **YES**.
2. Select a message type and press **YES**.

To turn on the Set on Send option, select *Set on Send*, then *On* and press **YES**.

Validity Period

If your message cannot be delivered, for example if the recipient has turned off the phone, your service

centre can save the message to send it later. If the service centre has not reached the recipient within a certain time, the message is deleted.

To set a validity period

1. Scroll to *Messages*, **YES**, *Options*, **YES**, *Validity Period*, **YES**, *Set Default*, **YES**.
2. Select a validity period and press **YES**.
To turn on the Set on Send option, select *Set on Send*, then *On* and press **YES**.

Reply to Messages

If you want the recipient of your message to reply, you can turn on the Request Reply option.

To turn the Request Reply function on or off

1. Scroll to *Messages*, **YES**, *Options*, **YES**, *Reply Request*, **YES**.
2. Select *On* or *Off* and press **YES**.

Templates

If you have one or more messages that you send often, you can save these as templates. You can save 10 templates consisting of up to 25 characters each.

Your phone may come with a set of templates that your operator or service provider has prepared for you. These templates appear in the list of templates, indicated by a letter icon with a dotted sheet. You cannot edit or delete these types of templates.

To create a template

1. Scroll to *Messages, YES, Templates, YES, Add new?, YES*.
2. Enter the message and press **YES**.
3. To send the template now, press **YES** when *Send message now?* appears and proceed as described in “To send a text message” on page 31.
Press **NO** if you do not want to send the template now.



To send a template later, select it from the *Template* list in the *Message* menu, and proceed as described in “To send a text message” on page 31.

Receiving a Message

When you receive a message, the phone beeps, the indicator light rapidly flashes green and the message *New message Read now?* appears in the display.

New message Read now?

To read the message now

1. Press **YES**.
2. Press  and  to scroll through the message. An arrow in the bottom right corner of the display indicates that there is more text in the message.
3. When you have read the message, press **YES**. A new menu with different options appears. These options are described on the following pages.

Note: *If the sender of the message wants you to reply, the message ‘Reply requested Reply?’ appears in the display. Press YES again to reply. If you do not want to reply, press NO.*

To read the message later

- Press **NO** to save the message in your *Inbox* in the *Message* menu.

To reply to a message

1. When you have read the message, press **YES**.
2. Select *Reply* in the option list and press **YES**.
3. Select the message you want to send as a reply and press **YES**. You can choose between:
 - Send new

- Include this Message. The message you received is included in your answer.
 - Any templates you have created.
4. Write your message and press **YES**.

To forward a message

1. When you have read the message, press **YES**.
2. Select *Forward* and press **YES**.
Continue in the same way as when sending a new text message.

To call a phone number found in a message

- When the number is highlighted, press **YES**.

To call the sender of the message

1. When you have read the message, press **YES**.
2. Select *Call* and press **YES**.

To read the next message

1. When you have read the message, press **YES**.
2. Select *Read Next* and press **YES**.

To delete a message

1. When you have read the message, press **YES**.
2. Select *Delete* and press **YES**.

Tip: *To delete a message from your Inbox, select the message and press c.*

Saving Incoming Messages

Incoming messages are saved in the phone memory. The phone memory can hold up to 10 messages. When the phone memory is full, the oldest read message is deleted when a new message is received.

If the phone memory becomes full of unread messages, new messages are automatically saved on the SIM card. Messages that are saved on the SIM card remain there until you delete them.

To save a message on the SIM card

1. When you have read the message, press **YES**.
2. Select *Save* and press **YES**.

E-mail addresses

You can save e-mail addresses to be used when you want to send a text message as an e-mail. You can save 10 e-mail addresses.

To save an e-mail address

1. Scroll to *Phone Book*, **YES**, *Email Addresses*, **YES**, *Add new?*, **YES**.
2. Enter an e-mail address and press **YES**.
3. Enter a name and press **YES**.

Area Information

The ordinary Short Message Service is a personal service that carries your private messages. Area Information is another type of text message that is sent to all subscribers in a certain network area.

This information could, for example, be a local traffic report or the phone number of a local taxi company.

To turn Area Information on or off

1. Scroll to *Messages*, **YES**, *Options*, **YES**, *Area Info*, **YES**, *Reception*, **YES**.
2. Select *On* or *Off* and press **YES**.

Area Information Codes

Please refer to the information provided by your operator for more information about the area information codes.



To insert an Area Information code

1. Scroll to *Messages*, **YES**, *Options*, **YES**, *Area Info*, **YES**, *Edit List*, **YES**, *Add new?*, **YES**.
2. Enter the new code and press **YES**.

Receiving an Area Message

When you receive an Area Information message, the message automatically appears in the display. You read the message in the same way as you read an ordinary text message. You cannot save area messages. When you have read the message and press **YES** or **NO**, it is deleted.

Cell Information

The “Cell information channel” is used by some network operators for sending messages to their subscribers within a certain network area. You read messages on the Cell information channel in the same way as when reading area messages.

- To turn on the channel, select *Cell Information* from the *Messages/Options* menu and then select *On*.



Profiles

A profile is a group of settings which are set to suit a certain environment. For example, when you go to a meeting, you can simply choose the *Meeting* profile and a number of settings that suit a meeting are set – the ring signal is turned off etc.

Some phone accessories can activate a profile automatically. For example, when you place your phone in a vehicle handsfree unit, the *In Car* profile is activated.

The Profiles

There are six profiles in the phone:

- Normal
- Meeting
- In Car
- Outdoors
- Port H-free (portable handsfree)
- Home

When you buy your phone, it is set to the *Normal* profile. You cannot create more profiles, but you can change the name of a profile, change the settings included in a profile or add an accessory to a profile.

You cannot change the name of or add any accessories to the *Normal* profile.

To choose a profile manually

1. Scroll to *Settings*, **YES**, *Profiles*, **YES**, *Select Profile*, **YES**.
2. Select a profile and press **YES**.

To change the name of a profile

1. Scroll to *Settings*, **YES**, *Profiles*, **YES**, *Edit Profile*, **YES**, *Profile Name*, **YES**.
2. Enter a new name and press **YES**.

To change a profile setting

1. Scroll to *Settings*, **YES**, *Profiles*, **YES**, *Edit Profile*, **YES**.
2. Select a setting and press **YES**.
3. Change the profile settings and press **YES** to confirm.

You can reset all profile settings to the way they were set when you bought your phone.

- Select *Reset Profiles* from the *Settings/Profiles* menu.

Automatic Activation

Some profiles, for example the *In Car* and the *Port H-free* profiles, are automatically activated when used with a specific accessory. When you disconnect your phone from the accessory, the profile is changed back to the one which was active before, if the current profile was activated automatically.

When you buy your phone, the automatic activation is set to on for the Vehicle and Portable handsfree profiles.

To turn automatic activation on or off

1. Scroll to *Settings*, **YES**, *Profiles*, **YES**, *Edit Profile*, **YES**, *Auto Activation*, **YES**.
2. Select *On* or *Off* and press **YES**.

Note: *A profile with no associated accessories, such as Meeting or Normal, must be chosen manually.*

Voice Control

With your phone you can:

- voice dial – call someone by saying the name.
- answer and reject calls by using your voice when connected to a portable handsfree.

Preparing Your Phone for Voice Dialling

Before you can use voice dialling, you need to record voice labels for your phone book entries. When recording voice labels, make sure you are in a quiet environment.

To record voice labels for a phone book entry

1. Scroll to *Phone Book*, **YES**, *Find and Edit*, **YES**.
2. Select a phone book entry and press **YES**.
3. Select *Add voice?*, and press **YES**.
4. Wait for the tone and say the name (voice label) you want to save.
The voice label is played back to you.
5. Press **YES** to save the voice label.
If the recording is not OK, press **NO** and repeat step 3.

Recording Problems

If your phone cannot detect any speech, one of the following might have happened:

- you spoke too softly – try speaking more loudly
- the voice label was too short – it should be around one second long
- you spoke too late or too soon – speak after the tone

To make a call using your voice

1. Press and hold **YES** (or either of the volume keys) until you hear a tone.
2. Release **YES** and say a name you have recorded earlier.

Your phone automatically dials the number.

To edit a voice label

1. Scroll to *Phone Book*, **YES**, *Voice Labels*, **YES**.
2. Select an entry and press **YES**.
3. Select *Replace Voice* or *Erase Voice* and press **YES**.

To turn Voice Dialling on or off

1. Scroll to *Phone Book*, **YES**, *Options*, **YES**, *Voice Dialling*, **YES**.
2. Select *On* or *Off* and press **YES**.

Voice Answering

When connected to a portable handsfree, you can answer or reject incoming calls by using your voice.

First you need to turn on the voice answering function and record your voice commands. Use the handsfree microphone.

To turn on Voice Answering

1. Scroll to *Settings*, **YES**, *Handsfree*, **YES**, *Voice Answering*, **YES**.
 2. Select *On* and press **YES**.
 3. Press **YES** again to continue.
 4. Follow the instructions in the phone display, i.e. say the word “answer” (or another word) and press **YES** to save your recording. If the recording was not OK, repeat step 3.
 5. Say the word “busy” (or another word) and press **YES** to save your recordings.
- These are the commands you use to answer or reject calls.

To answer or reject an incoming call using your voice

- When the phone rings, say the word **Answer** or **Busy**.

Diverting Incoming Calls

If you cannot answer an incoming voice, fax or data call, you can divert it to another number.

For voice calls, (not fax and data) you can choose between the following divert alternatives:

- *All Voice Calls* – divert all voice calls.
- *When Busy* – divert calls if you are already on the phone.
- *Not Reachable* – divert calls if your phone is turned off or if you are unreachable.
- *No Reply* – divert calls that you do not answer within a specified time limit (operator service).

To turn on a call divert

1. Scroll to *Settings, YES, Call Options, YES, Divert Calls, YES*.
2. Select a divert option and press **YES**.
3. Select *Activate* and press **YES**.
4. Enter the phone number to which you want your calls to be diverted and press **YES**, or retrieve it from the phone book by pressing .

Note: *When the Restricted Calls function is on, some Divert Calls options cannot be activated. See “Restrict Calls” on page 46.*

To turn off a call divert

1. Scroll to *Settings, YES, Call Options, YES, Divert Calls, YES*.
2. Scroll to a divert option and press **YES**.
3. Select *Cancel* and press **YES**.
 - Select *Get Status* to check if a divert option is on or off.

You can check the status of all divert options.

- Select *Check all* from the *Settings/Call Options/Divert Calls* menu.

Handling More Than One Call Simultaneously

Your phone can handle more than one call simultaneously. You can, for example, put an ongoing call on hold while you make or answer a second call, and then switch between the two calls.

You can also set up a conference Call to have a joint conversation with up to five people.

The Call Waiting Service

If the call waiting service is on, you hear a beep if you receive a second call during an ongoing call.

To turn the Call Waiting service on or off

1. Scroll to *Settings*, **YES**, *Call Options*, **YES**, *Call Waiting*, **YES**.
2. Select *Activate* or *Cancel* and press **YES**.
Select *Get Status* to check if call waiting is on or off.

Note: *If you are engaged in a fax or data call, incoming calls are rejected.*

Making a Second Call

1. Put the ongoing call on hold by pressing **YES**.
2. Enter the number you wish to call and press **YES**.
Press and hold  to retrieve a number from the phone book.

Note: *You can only put one call on hold.*

Receiving a Second Call

If the Call Waiting service is on, you hear a beep in the earpiece if you receive a second call. A list of alternatives, *Answer*, *Busy* and *Release&Answer*, is shown in the display. You can do one of the following:

Put the ongoing call on hold and answer the waiting call

- Press **YES** to answer the waiting call.
The held call is marked in grey and the active call is marked in black.

Continue the ongoing call and reject the waiting call

- Select *Busy*.

End the ongoing call and answer the waiting call

- Select *Release&Answer*.

One Active Call and One Call On Hold

When you have one active call and one call on hold, you can do one of the following:

Switch between the two calls

- Press **YES**.

End the active call and return to the call on hold

1. Press **NO**.
2. Press **YES**.

End both calls

- Scroll to *Ongoing Call*, **YES**, *Release All*, **YES**.

Connect the two calls

- Scroll to *Ongoing Call*, **YES**, *Transfer Call*, **YES**.

The two calls are now connected to each other, and you are disconnected from both.

Join the two calls into a conference call

- Scroll to *Ongoing Call*, **YES**, *Join Calls*, **YES**.

Receiving a Third Call

You cannot answer a third call without ending one of the first two calls.

End the current call and accept the waiting call

- Select *Release&Answer*.
The waiting call becomes active and the call on hold remains on hold.

Reject the waiting call

- Select *Busy*.

Conference Calls

You can include up to five participants in a conference call. To create a conference call, you must have one active call and one call on hold.

To join the two calls into a conference call

- Scroll to *Ongoing Call*, **YES**, *Join Calls*, **YES**.

To add a new participant

1. Press **YES** to put the conference group on hold.
2. Call the next person you wish to include in the conference group.

3. Scroll to *Ongoing Call*, **YES**, *Join Calls*, **YES**.
You can include up to five participants in the conference call by repeating steps 1 to 3 above.

To check the participants

- Select *Ongoing Call*, **YES**, *Parties in Conf*, **YES**.

You can extract one participant from the conference call for a private conversation and put the other participants on hold.

To extract a participant

1. Scroll to *Ongoing Call*, **YES**, *Extract Part*, **YES**.
2. Select a participant and press **YES**.

To rejoin the participant

- Scroll to *Ongoing Call*, **YES**, *Join Calls*, **YES**.

To release a participant

1. Scroll to *Ongoing Call*, **YES**, *Release Part*, **YES**.
2. Select a participant and press **YES**.

To release all participants

- Scroll to *Ongoing Call*, **YES**, *Release All*, **YES**.

You can put a conference on hold and make a new call. You can switch between the calls in the same way as when switching between two normal calls.

To end the conference call

- Press **NO**.

Call Time and Call Cost

During a call, the duration of the call is shown in the display. If you subscribe to cost information, the call cost (or the number of call units) is displayed instead.

Call Time

You can check the duration of your *Last Call*, *Outgoing Calls*, *Incoming calls* and the *Total time*.

To Check the Call Time

1. Scroll to *Call Info*, **YES**, *Call Timers*, **YES**.
2. Select a call time and press **YES**.
3. Select *Clear Timers* if you want to reset a call time counter.

Call Cost

You can check the cost of your *Last Call* and the *Total Cost* of your calls.



To check the call cost

1. Scroll to *Call Info*, **YES**, *Call Cost*, **YES**.
2. Select a call cost and press **YES**.
3. Select *Clear Total Cost* to reset the counter.

Note: If you subscribe to cost information, you must enter your PIN2 to clear the cost or time counter.

SMS Counter

You can check the number of text messages that you have sent.

To check the number of sent messages

- Scroll to *Call Info*, **YES**, *Call Costs*, **YES**, *Sent SMS*, **YES**.
Select *Clear Msg Count* to reset the counter.

Determining the Call Cost

You can use the ‘tariff’ function to specify the price per call unit. If you do not specify a price per call unit, the number of call units is displayed instead.

To enter the price per call unit

1. Scroll to *Call Info*, **YES**, *Call Costs*, **YES**, *Set Tariff*, **YES**.
2. Enter your PIN2 and press **YES**.
3. Select *Change Tariff* and press **YES**.
4. Enter the code for the currency you want, (for example GBP for Pounds Sterling), and press **YES**.

5. Enter the price per call unit and press **YES**.
To enter a decimal point, press *****.

Credit Limit for Calls

If supported by your network and your subscription, you can enter a total amount of money that can be used for making calls. When the amount reaches zero, no more calls can be made. Please note that the credit limit is only an estimated value.

To set a specific credit limit

1. Scroll to *Call Info*, **YES**, *Call Costs*, **YES**, *Set Credit*, **YES**.
2. Enter your PIN2 and press **YES**.
3. Select *Change Credit* and press **YES**.
4. Enter an amount and press **YES**.
To set an unlimited credit, select *Unlimited*.

Security for Your Phone and Subscription

The SIM Card Lock

The SIM card lock protects your subscription, but not your phone itself, from unauthorized use. If you change SIM cards, the phone still works with the new SIM card.

Most SIM cards are locked at the time of purchase. If the SIM card lock is on, you have to enter a “PIN” (Personal Identity Number) every time you turn on your phone.

If you enter your PIN incorrectly three times in a row, the SIM card is blocked. This is indicated by the message *PIN blocked*. To unblock it you need to enter your “PUK” (Personal Unblocking Key). Your PIN and PUK are supplied by your operator.

To unblock your SIM card

1. *PIN blocked* appears in the display.
2. Enter your PUK and press **YES**.
3. Enter a new four- to eight-digit PIN and press **YES**.
4. Re-enter the new PIN to confirm and press **YES**.

To change your PIN

1. Scroll to *Settings*, **YES**, *Locks*, **YES**, *Card Lock*, **YES**, *Change PIN*, **YES**.
2. Enter your old (current) PIN and press **YES**.
3. Enter your new PIN and press **YES**.
4. Re-enter the new PIN to confirm and press **YES**.

Note: If the message ‘Codes do not match’ appears, you entered the new PIN incorrectly. If the message ‘Wrong PIN’ appears, followed by ‘Old PIN:’, you entered your old PIN incorrectly.

To change your PIN2

1. Scroll to *Settings*, **YES**, *Locks*, **YES**, *Card Lock*, **YES**, *Change PIN2*, **YES**.
2. Proceed as described in “To change your PIN”.

To turn the SIM card lock on or off

1. Scroll to *Settings*, **YES**, *Locks*, **YES**, *Card Lock*, **YES**, *Protection*, **YES**.
2. Select *On* or *Off*, and press **YES**.
3. Enter your PIN and press **YES**.

The Phone Lock

The phone lock protects the phone against unauthorized use if it is stolen and the SIM card is exchanged. It is not on when you buy the phone. You can change the phone lock code (0000) to any four-to-eight-digit personal code. The phone lock can be set to on, automatic or off.

Phone Lock On

If the phone lock is on, the message *Phone locked* *Phone lock code:* appears each time you turn on the phone. You have to enter your code followed by **YES** to use your phone.

Automatic

If the phone lock is set to automatic, you do not need to enter your phone lock code until a different SIM card is inserted in the phone.

Changing the phone lock code

1. Scroll to *Settings*, **YES**, *Locks*, **YES**, *Phone Lock*, **YES**, *Change Code*, **YES**.
2. Follow the steps described in “To change your PIN” on page 45.

Note: It is important that you remember your new code. If you should forget it, you have to hand in your phone to your local Ericsson retailer.

To set the phone lock

1. Scroll to *Settings*, **YES**, *Locks*, **YES**, *Phone Lock*, **YES**, *Protection*, **YES**.
2. Select an alternative and press **YES**.
3. Enter the phone lock code and press **YES**.

Restrict Calls

The Restrict Calls service allows you to restrict certain types of calls being made and received.

You need a password, which comes with your subscription, to activate or cancel a call restriction.

The following calls can be restricted:

- all outgoing calls, *All Outgoing*
- all outgoing international calls, *Outgoing Intl*
- all outgoing international calls except to your home country, *Outg Intl Roam*
- all incoming calls, *All Incoming*
- all incoming calls when you are abroad (when roaming), *Inc when Roam*

To turn a call restriction on or off

1. Scroll to *Settings*, **YES**, *Call Options*, **YES**, *Restrict Calls*, **YES**.
2. Select an option and press **YES**.
3. Select *Activate* or *Cancel* and press **YES**.
4. Enter your password and press **YES**.

- To check the status of a call restriction, select the call restriction and then *Get Status*.
- To turn off all call restrictions, select *Cancel All*.
- To change the password, select *Change Passwd*.

Note: If you divert incoming calls, you cannot activate some Restrict Calls options. Likewise, if you restrict calls, you cannot activate some Divert Calls options.

Fixed Dialling

The Fixed Dialling function allows calls to be made only to certain numbers saved on the SIM card. If an attempt is made to call other numbers, the message *Number not permitted* appears in the display. Fixed dialling requires a SIM card that allows fixed numbers to be saved. The fixed numbers are protected by your PIN2.

- Partial numbers can be saved. For example, storing 0123456 allows calls to be made to all numbers starting with 0123456.
- Numbers that include question marks can be saved. For example, storing 01234567?0, allows calls to be made to numbers from 0123456700 to 0123456790. To enter a question mark, press and hold #.

Note: *Calls to the international emergency number 112 can still be made, even when Fixed Dialling is on.*

To turn Fixed Dialling on or off

1. Scroll to *Phone Book*, **YES**, *Options*, **YES**, *Fixed Dialling*, **YES**.
2. Enter your PIN2 and press **YES**.
3. Select *On* or *Off* and press **YES**.

To save a fixed number

- Select *Add new?* from the *Phone Book/Fixed Numbers* menu, then enter the number.

Closed User Groups

The *Closed User Group* function is a way of lowering call costs. On some networks it



is cheaper to make calls within a call group. Your network operator can place certain numbers in groups. You can have a maximum of 10 groups.

To add a group

1. Scroll to *Settings*, **YES**, *Call Options*, **YES**, *Closed Groups*, **YES**, *Edit List*, **YES**.
2. Scroll to *Add new?* and press **YES**.
3. Enter the name of the user group and press **YES**.
4. Enter the index number and press **YES**.
You get the index number from your operator.

To activate a group

1. Scroll to *Settings*, **YES**, *Call Options*, **YES**, *Closed Groups*, **YES**, *Edit List*, **YES**.
2. Select a group and press **YES**.
3. Select *Activate* and press **YES**.
Calls can only be made within the selected group.

To call outside Closed User Groups

1. Scroll to *Settings*, **YES**, *Call Options*, **YES**, *Closed Groups*, **YES**, *Open Calls*, **YES**.
2. Select *On* and press **YES**.

Accept Calls

With the Accept Calls service, you can choose to receive calls only from certain numbers. Other calls are rejected by a busy tone. You have to save the numbers that you want to receive in an Accepted Callers List. The numbers must first be saved in your phone book. The rejected calls are saved in the Call List.

To add numbers to the Accepted Callers List

1. Scroll to *Settings*, **YES**, *Call Options*, **YES**, *Accept Calls*, **YES**, *Accepted List*, **YES**.
2. Scroll to *Add new?*, **YES**.
This takes you to the phone book.
3. Select an entry and press **YES**.

To set the accept calls option

1. Scroll to *Settings*, **YES**, *Call Options*, **YES**, *Accept Calls*, **YES**, *Accept Options*, **YES**.
2. Select an option and press **YES**.

Using Two Voice Lines

If you subscribe to the “Two Line Service”, you can choose which line you want to use for outgoing calls. Incoming calls can be received on both lines, irrespective of the line currently chosen.



When you buy your phone, the names of the lines are normally Line 1 and Line 2. You can have different settings for your two lines, for example, ring signal, call divert.

Before you make a call, you need to choose which line to use.

To choose a phone line

1. Scroll to *Call Info*, **YES**, *Next Call*, **YES**.
2. Select the line you want and press **YES**.
All outgoing calls are made on this line until you change it.

You can change the name of your lines, for example “private” and “work”.

- Select *Edit Line Tags* from the *Settings/Display* menu and then select the line you want.

Calling Card Calls

The Calling Card Service lets you redirect the charges to either a credit card account or to a calling card account, instead of your normal account.



You can save two separate calling card numbers in your phone. The numbers are protected by the phone lock code. See “The Phone Lock” on page 45.

Note: *You cannot use the Calling card service for fax and data calls.*

Activating the Calling Card Service

To be able to make calling card calls, you need to turn on the service.

To turn on the calling card service

1. Scroll to *Phone Book*, **YES**, *Options*, **YES**, *Set Calling Cards*, **YES**.
2. Enter your phone lock code and press **YES**.
3. Select *On* and press **YES**.

To save a card number

1. Scroll to *Phone Book*, **YES**, *Calling Cards*, **YES**.
2. Enter your phone lock code and press **YES**.
3. Select *Add new?* and press **YES**.
4. Enter the access number of the calling card server and press **YES**.
5. Enter a name and press **YES**.
6. Enter the verification code of the calling card server and press **YES**.
7. Select which you want to send first – the number you want to call or the verification – and press **YES**.

Choosing a Card

Before you can make a calling card call, you need to activate the card that you want to use. If you have saved two card numbers, you must choose which card you want to use.

To select a card

1. Scroll to *Phone Book*, **YES**, *Calling Cards*, **YES**.
2. Enter your phone lock code and press **YES**.
3. Select the card you want and press **YES**.
4. Select *Activate card* and press **YES**.

Making a Calling Card Call

1. Enter the phone number of the person you want to call.
2. Press and hold **YES**.
The access number of the calling card server is called. During the connecting phase, you are asked to send the phone number you want to call and the verification code, in the order chosen earlier.
3. Press **YES** when the display shows *Send* or wait a few seconds and the number and code are sent automatically.

Setting Network Preferences

When you turn on the phone, it automatically searches for your home network. If this is not within range, you may use another network, provided your network operator has an agreement that allows you to do so. This is called roaming.

To select a network

1. Scroll to *Settings*, **YES**, *Networks*, **YES**, *Select Network*, **YES**.
2. Select a network and press **YES**.

To start an automatic network search

- Scroll to *Settings*, **YES**, *Networks*, **YES**, *New Search*, **YES**.

List of Preferred Networks

You can edit the list that defines in which order your phone will select a network during automatic network selection. The list is set by your operator and stored on the SIM card.

To review the list of networks

- Scroll to *Settings*, **YES**, *Networks*, **YES**, *Preferred Nets*, **YES**.
- To see a network's full name, select the network and then select *Full Name*.

To add a network to the list

1. Scroll to *Settings*, **YES**, *Networks*, **YES**, *Preferred Nets*, **YES**, *Add new?*, **YES**.
2. Select the network you want and press **YES**.
3. If the network you want does not appear in the list, scroll to *Other* and press **YES**.
4. Enter the three-digit country number and the two-digit network number and press **YES**.
5. Enter a position number and press **YES**.

To rearrange the list

1. Scroll to *Settings*, **YES**, *Networks*, **YES**, *Preferred Nets*, **YES**.
2. Select the network you want to move and press **YES**.
3. Select *Change Priority* and press **YES**.
4. Enter the new position number and press **YES**.

Search Modes

- **Automatic search mode** means that your phone first searches for the last accessed network. If this is not available, it automatically searches for another available network within range.
- **Manual search mode** means that your phone first searches for the last accessed network, but if this is not available, the question *Select net?* appears. You then need to choose a network as described in “To select a network” on page 50.

To select automatic or manual search mode

- Select *Automatic* or *Manual* from the *Settings/Networks/Search Mode* menu and press **YES**.

Fax and Data Calls

Sending Fax and Data Calls

To send fax and data calls you need to connect your phone to a computer, and then start the appropriate software program.

Receiving Fax and Data Calls

The procedure of receiving fax and data calls depends on your network and subscription. If you have separate numbers for voice, fax and data calls, your phone will recognize the type of call.

To receive a fax or data call (separate numbers)

1. Connect your phone to a computer.
2. Answer the call from within the software program (if it does not answer automatically).

You cannot answer a fax or data call by pressing the **YES** key on the phone.

One Number

If you have a SIM card that does not support separate fax and data numbers, the phone does not recognize the type of incoming call.

If you want to receive a fax or data call you have to set the phone to one of these options. Once you have set your phone for a specific incoming call, it stays like this until you change it.

To set the next incoming call type

1. Scroll to *Call Info*, **YES**, *Next Call*, **YES**, *Next Incoming*, **YES**.
2. Select the call type you want and press **YES**.

Extras

Alarm Clock

The phone has an alarm clock which rings at the time set, even if the phone is turned off. The alarm rings for 60 seconds and is repeated every nine minutes for 60 minutes if you do not turn it off.

To set the alarm

1. Scroll to *Extras*, **YES**, *Alarm Clock*, **YES**.
2. Enter the time and press **YES**.

To turn the alarm signal off

- Press any key to turn the alarm off when it rings. If you do not want the alarm to be repeated, press **YES**.

To turn the alarm function off



1. Scroll to *Extras*, **YES**, *Alarm Clock*, **YES**.
2. Select *Cancel* and press **YES**.

To change the alarm signal

1. Scroll to *Settings*, **YES**, *Sounds & Alerts*, **YES**, *Alarm Signal*, **YES**.
2. Select a signal and press **YES**.

Calculator

The phone has a built-in calculator which can add, subtract, divide and multiply.

- Press **#** or  or  to get +, -, x, /.
- Press **c** to erase.
- Press ***** to enter a decimal point.

To use the calculator

In this example, we are going to divide 134 by 32.



1. Scroll to *Extras*, **YES**, *Calculator*, **YES**.
2. Enter 134.
3. Press **#** repeatedly until the division sign (/) appears.
4. Enter 32.
5. Press **YES** to get the answer.
6. To clear the display, press **c**.

Stopwatch

The phone has a built-in stopwatch.

To run the stopwatch

1. Scroll to *Extras*, **YES**, *Stopwatch*, **YES**.
2. Press **YES** to start the stopwatch.
3. Press **YES** again to stop it.
4. Press **c** to reset the stopwatch.

Tip: By pressing # when the stopwatch is running, you can store up to 9 lap times. Press  or  to check your lap times.

Note: The stopwatch is turned off if you receive a call or text message, or if you exit the stopwatch menu.

Timer

The phone has a built-in 24-hour timer. You set the time you want and when that time is up, the phone beeps.

To set the timer

1. Scroll to *Extras*, **YES**, *Timer*, **YES**.
2. Enter the time and press **YES** to start the timer.
3. When the alert sounds, press any key to turn it off.

Games

Your phone has three games. Help texts are available in each game.

Tetris®

The object of Tetris is to prevent the blocks from reaching the top. Each time you fill a line, the line disappears.

To start Tetris

1. Scroll to *Extras*, **YES**, *Games*, **YES**, *Tetris*, **YES**.
2. To start a game, select *Start* and press **YES**.
3. Select level (1–10).
4. Press any key to start.

Instead of choosing *Start* you can select *High-score* or *Help* by pressing  at step 2.

To control Tetris

- **8** or press the lower volume key = move left
- **2** or press the upper volume key = move right
- **5** or **9** = rotate
- **3** or **6** = drop faster
- **c** = pause
- **NO** = quit

Tetris®; © Elorg 1987. Classic Tetris™; © Elorg 1998. Tetris Logo by Roger Dean; © The Tetris Company 1997. All Rights Reserved.

Erix

The object of Erix is to fill the display. You draw a line and when the line is connected at both ends, the contained area is filled. When you have filled approximately 75% of the display you move up to the next level. If a ball hits you or the line you are drawing, you lose a life.

To control Erix

- **2** = up, **8** = down, **4** = left, **6** = right

To start Erix

1. Scroll to *Extras*, **YES**, *Games*, **YES**, *Erix*, **YES**.
2. Select *New Game* and press **YES**.

Instead of selecting a *New Game*, you can select *Difficulty*, *Help*, *High-score* or *Resume Game* by pressing  at step 2. Press either of the volume keys to switch difficulty level.

E-Maze

The object of E-Maze is to eat all the “dots” and avoid being eaten by the monsters. When you eat any of the “bullets” in the corner, you can fire at the enemies. Collect the diamond, when it appears, for bonus points.

To control E-Maze

- **2** = up, **8** = down, **4** = left, **6** = right, **1** or **3** = fire

To start E-Maze

1. Scroll to *Extras*, **YES**, *Games*, **YES**, *E-Maze*, **YES**.
2. Select *Start* and press **YES**.
3. Select *Easy*, *Normal*, or *Hard*, and press **YES**.
Instead of choosing start, you can select *Help* or *High-score* by pressing  at step 2.

The WAP Browser

Your phone has a WAP browser which lets you connect to the Internet and access with specially designed interactive services and view WAP pages. WAP (Wireless Application Protocol) is a standard specially created for mobile communications devices and gives fast access to information and services on the Internet.



Note: *Your phone uses SMS as a bearer for WAP. Not all network operators support WAP over SMS. For more information, please contact your operator.*

Examples of WAP services you may find are:

- Ericsson Mobile Internet, a portal offering you online access to customer services, user guides and useful information when you are travelling. The address to Ericsson Mobile Internet is:
mobileinternet.ericsson.com
- Reservation services.
- News, sports and weather.
- Restaurants, cinemas, games etc.
- Banking and stock exchange quotations.
- Voice mail, e-mail and fax mail.

Preparing Your Phone for WAP

Before you can start using the WAP browser, you need to make sure that your access settings are correctly set. You need to set your User ID and Gateway address, among other things.

Depending on your network operator, you can receive the access settings you need in different ways.

- When you buy your phone together with a WAP subscription. Your operator has already entered all the WAP settings you need.

- Over the air via SMS. Your operator sends you a text message with the access settings you need. When this happens you will be asked if you want to install the settings and specify which WAP profile you want them to apply to.

Note: *Always make sure who the sender of the message is, before you install any settings. If you are unsure, choose not to install any settings by pressing NO. Call your operator and ask them to send the settings again, if it was in fact your operator who sent the message.*

- Manually by yourself. Your operator or another service provider, for example your company, provides you with the settings you need. You then have to enter them yourself.

Entering the WAP settings manually

The WAP settings you enter will be associated with one of the WAP profiles. If you want to use more than one WAP profile, you need to specify the settings for each profile. See “Using WAP profiles” on page 60.

Note: Please refer to the information provided by your operator before you enter your settings.

To set up your WAP connection

1. Scroll to *Extras*, **YES**, *Wap Services*, **YES**, *Wap Settings*, **YES**.
2. Select a WAP profile and press **YES**.
3. Scroll to *Gateway*, **YES**, *User ID*, **YES**.
4. Enter the User ID to your gateway and press **YES**.
5. Select *Password* and press **YES**.
6. Enter the password to your gateway and press **YES**.
7. Select *SMS address* and press **YES**.
8. Enter the phone number to your gateway and press **YES**.

After you have entered the SMS address phone number, press **NO** to go back one level in the menus. Now you need to enter the phone number to your service centre.

1. Select *Service Centre* and press **YES**.
2. Enter the phone number to your service centre and press **YES**.

Now, you have entered the settings you need to start the WAP browser.

Open a WAP page

There are three ways to open a WAP page:

- by opening a homepage.
- by entering the address of the WAP page.
- by opening a bookmark that you have saved. See “Bookmarks” on page 59.

Open a homepage

When you by your phone Ericsson Mobile Internet is set as your homepage for all WAP profiles. If you want to, you can choose another WAP page as your homepage, see “To change homepage” on page 58.

To open a homepage

1. Scroll to *Extras*, **YES**, *Wap Services*, **YES**.
2. Select the top menu and press **YES**.
The name of this menu depends on what you have chosen to call it. See “To edit the homepage of a WAP profile” on page 60.

To go to a WAP page by entering the address

1. Scroll to *Extras*, **YES**, *Wap Services*, **YES**, *Enter Address*, **YES**.
2. Enter the address, for example **mobileinternet.ericsson.com** and press **YES**.

Tip: *If the WAP address starts with http://, you do not need to enter this prefix. You only need to enter the prefix if it starts with something else, for example, ftp://.*

To change homepage

1. Scroll to *Extras*, **YES**, *Wap Services*, **YES**, *Wap Settings*, **YES**.
2. Select the WAP profile you want and press **YES**.
3. Select *Edit Homepage* and press **YES**.
4. Enter a name for this homepage and press **YES**.
5. Enter the address to the WAP page you want to set as your homepage and press **YES**.

Options While You are Browsing

While you are browsing you can press and hold **YES** to reach an options menu. The menu may look different depending on what page you are browsing. It can, for example contain special features of the

WAP page you are currently browsing. It always, however, contains the options below:

- *Go to Menu*. Go back to the WAP services menu where you can access your bookmarks among other things.
- *Reload page*. Get the latest version of the WAP page you are browsing.
- *Add bookmark*. Add the page you are currently browsing to your list of bookmarks.
- *Send as link*. Send the current page as a bookmark to another person via SMS.
- *New homepage*. Set the current WAP page as your homepage.
- *Exit WAP*. End your browsing.

To reach the options menu

- Press and hold **YES** while you are browsing. If you select *Go to Menu* from the options menu, you can easily return to the WAP page you are currently browsing.

To return to the browser

- Scroll to *Wap Services*, **YES**, *Resume*, **YES**.

Bookmarks

If there are some WAP pages that you visit often, you can save these as bookmarks, making it easier to go to these pages.

Note: *You can only add bookmarks while you are browsing.*

To add a bookmark

1. Start the browser in one of the ways described in this chapter.
2. Go to the WAP page you want to bookmark.
3. Press and hold **YES** until the *Options* menu appears.
4. Select *Add bookmark* and press **YES**.
Wait until the message *Bookmark saved* appears in the display.

To open a bookmark while browsing

1. When you are browsing, press and hold **YES** until the *Options* menu appears.
2. Scroll to *Go to Menu*, **YES**, *Bookmarks*, **YES**.
3. Select the bookmark you want and press **YES**.
4. Select *Go to* and press **YES**.

Images

If you do not want to display the images on the WAP page that you are browsing, you can turn them off. Images take longer to download, but the WAP page may look better with them.

If an image contains a link, you can access the link by highlighting the image, then press **YES**.

If you turn off the Show images function, the images appear as icons in the display.

To turn the show images function on or off

1. Scroll to *Extras*, **YES**, *Wap Services*, **YES**, *Wap Settings*, **YES**.
2. Select a WAP profile and press **YES**.
3. Scroll to *Show Images* and press **YES**.
4. Select *On* or *Off* and press **YES**.

Download Timeout

Some WAP pages can take a long time to download. You can specify the time that should pass before the download attempt is stopped.

To set the download timeout

1. Scroll to *Extras*, **YES**, *Wap Services*, **YES**, *Wap Settings*, **YES**.
2. Select a WAP profile and press **YES**.
3. Select *Response Timer* and press **YES**.
4. Enter how many seconds you want the download to continue before it stops, and press **YES**.

Using WAP profiles

Your phone comes with three WAP profiles, in order to simplify your browsing. You can, for example associate one profile to your operator's WAP page and one to your company's intranet. Instead of having to enter the access settings, when you want to switch between your operator's WAP page and your company's intranet, you can simply switch profiles.

It is important to remember two things about the WAP profiles:

- You can set different homepages, one for each WAP profile. When you switch profile, the homepage changes to the homepage set for that profile.
- A saved bookmark may not work with all WAP profiles. When you save a bookmark, it is associated with the WAP profile that you are currently using. If you cannot access a bookmark, you may solve the

problem by switching profiles and then accessing the bookmark again.

To switch WAP profiles

1. Scroll to *Extras*, **YES**, *Wap Services*, **YES**, *Wap Profile*, **YES**.
2. Select a WAP profile and press **YES**.
This WAP profile is active until you switch again.

Renaming a Wap Profile

You can change the name of your WAP profiles to a name of your own choice.

To change the name of a WAP profile

1. Scroll to *Extras*, **YES**, *Wap Services*, **YES**, *Wap Settings*, **YES**.
2. Select a WAP profile and press **YES**.
3. Select *Rename* and press **YES**.
4. Enter a new name and press **YES**.

To edit the homepage of a WAP profile

1. Scroll to *Extras*, **YES**, *Wap Services*, **YES**, *Wap Settings*, **YES**.
2. Select the WAP profile you want and press **YES**.
3. Select *Edit Homepage* and press **YES**.

4. Enter a guiding name for this profile and press **YES**.
5. Enter the address to the WAP page you want to set as your homepage for this profile and press **YES**.

Online Services

The Online Services is the network operators' way of offering customized services, independently of mobile phones and mobile phone manufacturers.



New Menu

A SIM card which supports the Online Services works in the same way as a normal SIM card.

When you have inserted your SIM card and turned on your phone, your network operator can download data to your SIM card. After the first data download and after restarting your phone, a new menu appears. In your phone, this menu appears as the first sub-menu under the *Extras* menu.

To enter your new menu system

- Scroll to *Extras*, **YES**, *Online Services*, **YES**.

Note: *This menu only appears if your SIM card supports this service. Some operators may not use the name 'Online Services'.*

Data Download to the SIM

Your network operator can at any time download new data, for example a new feature, to your SIM card over the air.

Resetting your SIM Card

When the operator updates your SIM card over the air, the phone notifies you by showing a message in your display. You also hear a beep. The message can, for example, prompt you to make a call or send a text message (SMS).

In order for your new SIM settings to take effect, you have to turn off your phone and then turn it on again.

Note: *Your phone does not support all services offered by the Online Services. The Online Services on the SIM card are provided by network operators and not by mobile phone manufacturers.*

Ericsson Mobile Internet

The **Mobile Internet** is a service supplied by Ericsson to make it easier for you to communicate and receive information quickly, wherever you are. It gives you access to various messaging services, on-line customer services, user manuals and other useful information. With the **Mobile Internet** you can also download communications software to ensure you get the best out of your Ericsson products.

The Ericsson Mobile Internet address is:
<http://mobileinternet.ericsson.com>

Changing Covers

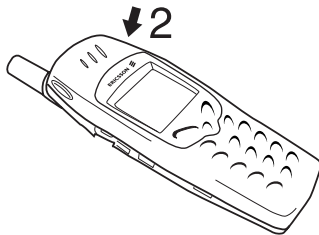
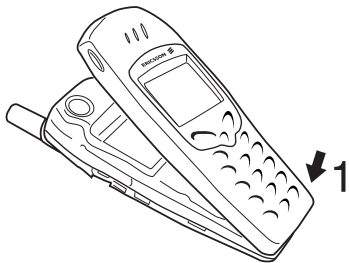
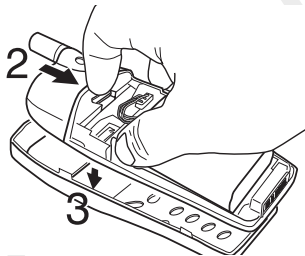
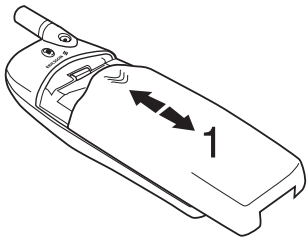

Troubleshooting

This chapter lists some problems that you might encounter while using your phone. Some problems require that you call your service provider, but most of the problems you can easily correct yourself.

The Phone Cannot be Switched On Hand-held Phone

- Recharge or replace the battery. See “The Battery” on page 7.

Handsfree Phone in Vehicle





Make sure that the phone is properly inserted into its holder.

No Indication of Charging

When you start charging a battery that is empty or a battery that has not been used for a long time, it may take a while before the battery meter appears in the display.

Display language

If the display shows a language that you do not understand, you can always choose Automatic

(determined by your SIM card) by pressing  8888  in standby. You can always choose English by pressing  0000  in standby.

Error Messages

Insert Card

There is no SIM card in the phone or you may have inserted it incorrectly. Insert a SIM card. See “The SIM Card” on page 4.

Insert Correct SIM Card

The phone is set to work only with certain SIM cards. Insert the correct SIM card.

SOS Calls Only

You are within range of a network, but you are not allowed to use it. However, in an emergency, some operators allow you to call the international emergency number 112. See “Making Emergency Calls” on page 10.

No Network

There is no network within range or the received signal is too weak. You have to move to get a signal that is strong enough.

Wrong PIN, Wrong PIN2

You have entered your PIN or PIN2 incorrectly.

- Enter the correct PIN or PIN2, and press **YES**.
See “The SIM Card Lock” on page 44.

Codes do not match

When you want to change a security code (for example your PIN) you have to confirm the new code by entering it again. The two codes that you have entered do not match. See “The SIM Card Lock” on page 44.

PIN/PIN2 Blocked

You have entered your PIN or PIN2 incorrectly three times in a row. To unblock, see “The SIM Card Lock” on page 44.

PUK blocked – Contact operator

You entered your personal unblocking key code (PUK) incorrectly 10 times in a row. Contact your network operator provider or service provider.

Phone Locked

The phone is locked. To unlock the phone, see “The Phone Lock” on page 45.

Phone lock code:

Your phone comes with the phone lock code, 0000. You can change it to any four- to eight-digit code. See “The Phone Lock” on page 45.











Number not permitted













The Fixed Dialling function is on and the number you have dialled is not on your fixed numbers list. See “Fixed Dialling” on page 46.





Charging, alien battery

The battery you are using is not an Ericsson-approved battery and is charging slowly for safety reasons.



Display Icons

Symbol	Description
	Network signal indicator.
	Battery status indicator.
	The ring signal is turned off.
	All audible signals are turned off, except the alarm and timer.
	The alarm clock has been set and is on.
	All incoming calls will be diverted to a defined number.
	You have an ongoing call.
	Indicates a missed call in the call list.
	Indicates an answered call in the call list.
	Indicates a dialed number in the call list.

Symbol	Description
	Line 1 is in use for outgoing calls.
	Line 2 is in use for outgoing calls.
	The phone book entry is saved in the phone memory.
	The phone book entry is a group.
	Unread text message.
	Unchecked voice message.
	You can enter the phone book by pressing  .
	The text message is saved in the SIM card memory.
	Voice label recorded for that entry.
	Preferred network.
	Forbidden network.

Symbol	Description
	Your home network is within range.
	Indicates a help text.
	The card lock or phone lock is on.
	The keypad is locked.
	Ciphering is currently not being provided by the network.

Quick Keys

To...	Do this:
enter the <i>Call List</i>	press YES from standby
to enter the first function in the menu <i>My Shortcuts</i>	press and hold  from standby
to enter the <i>Find and Call</i> menu	press and hold  from standby
voice dial	press and hold YES from standby
call your voice mail service	press and hold 1 from standby
enter the + sign to make an international phone call	press and hold 0 from standby
set the phone to silent	press and hold c from standby
turn off the microphone	press and hold c during a call
speed dial (phone book positions 1–9)	press any of the number keys 1-9 and YES from standby

To...

find a phone book entry beginning with the first letter (or the closest following) on a key

find a phone book entry

put a call on hold

switch between two calls

Do this:

press and hold any of the keys 2-9 from standby

enter the position number and press # from standby

press YES

press YES

Technical Data

General

Product name	A2618
System	GSM 900/GSM 1800
SIM Card	Small plug in card 3V or 5V

Dimensions

Size	131 x 51 x 25 mm
Weight with standard battery	140 g

Ambient temperatures

Max	+55°C
Min	-10°C

Guidelines for Safe and Efficient Use

Product Care and Maintenance

Your mobile phone is a highly sophisticated electronic device. To get the most out of your mobile phone read this text about product care, safe and efficient use.

Product Care

- Keep your mobile phone dry.
- Avoid exposing your mobile phone to extreme hot or cold temperatures.
- Avoid placing your mobile phone close to lit candles, cigarettes, naked flames or any heat source.
- As with all sophisticated electronic devices rough treatment could damage your mobile phone.
- Only use a soft damp cloth to clean your mobile phone.
- Do not paint your mobile phone as the paint could obstruct the earphone, microphone or any moveable parts and prevent normal use.
- Do not attempt to disassemble your mobile phone, a broken warranty seal will void the warranty. The phone does not contain consumer serviceable components. Service should only be performed by Certified Service Partners.
- Only use Ericsson original accessories. Failure to do so may result in loss of performance, damage to the

phone, fire, electric shock or injury. The warranty does not cover product failures which have been caused by use of non-Ericsson original accessories.

- Treat your mobile phone with care, keep it in a clean and dust free place.

Antenna Care and Replacement

- To avoid impaired performance please ensure your mobile phone's antenna is not bent or damaged.
- Do not remove the antenna yourself. If your phone's antenna is damaged please take it to a Certified Service Partner.
- Only use an antenna that has been specifically designed for your phone. Unauthorised antennas, modifications, or attachments could damage the phone and may violate the appropriate regulations causing loss of performance and radio frequency (RF) energy above the recommended limits.

Efficient Phone Operation

To enjoy optimum performance with minimum power consumption please:

- Hold the phone as you would any other telephone. While speaking directly into the mouthpiece, angle the antenna in a direction up and over your shoulder. If the antenna is extendable/retractable, it should be extended during a call.

- Do not hold the antenna when the phone is in use. Holding the antenna affects call quality, may cause the phone to operate at a higher power level than needed and shorten talk and standby times. If your mobile phone is equipped with an infrared eye, never direct the infrared ray at anyone's eye and make sure that it does not disturb any other infrared units.

Radio Frequency Energy

Your mobile phone is a radio transmitter and receiver. When the phone is turned on, it receives and transmits radio frequency (RF) energy. Depending on the type of mobile phone you possess, it operates on different frequency ranges and employs commonly used modulation techniques. The system that handles your call when you are using your phone controls the power level at which your phone transmits.

Exposure to Radio Frequency Energy

The International Commission on Non-Ionising Radiation Protection (ICNIRP), supported by the World Health Organisation (WHO), published during 1996 a statement and in 1998 guidelines which set recommended limits for exposure to RF fields from handheld mobile telephones. According to ICNIRP statement, which is based on the available body of research, there is no evidence that mobile terminals meeting the recommended limits can cause any

adverse health effects. All Ericsson telephones conform to the ICNIRP guidelines and other international exposure standards, such as:

- CENELEC European Pre-standard ENV50166-2:1995 (Europe)
- ANSI/IEEE C95.1-1992 (USA, Asia-Pacific)
- AS/NZS 2772.1 (Int):1998 (Australia, New Zealand)

Driving

Check the laws and regulations on the use of mobile phones in the areas where you drive. If you are going to use your phone while driving, please:

- Give full attention to driving.
- Use an Ericsson Vehicle Handsfree Solution, if available. Law in many countries requires vehicle Handsfree Solution. Read the installation instructions carefully before installing a vehicle Handsfree Solution.
- Pull off the road and park before making or answering a call if driving conditions so require.

RF energy may affect some electronic systems in motor vehicles such as car stereo, safety equipment etc. In addition, some vehicle manufacturers do not allow use of mobile phones, unless the installation is supported by a handsfree kit with an external antenna, in their vehicles. Check with your vehicle manufacturer's representative to be sure that your mobile phone will not affect the electronic systems in your vehicle.

Vehicles Equipped with an Air Bag

An air bag inflates with great force. Do not place objects, including either installed or portable wireless equipment, in the area over the air bag or in the air bag deployment area. If in-vehicle wireless equipment is improperly installed and the air bag inflates, serious injury could result.

Electronic Devices

Most modern electronic equipment, for example equipment in hospitals and cars, is shielded from RF energy. However, certain electronic equipment is not, therefore:

- Do not use your mobile phone near medical equipment without requesting permission.

Mobile phones may affect the operation of some implanted cardiac pacemakers and other medically implanted equipment. Pacemaker patients should be aware that the use of a mobile phone very close to a pacemaker might cause the device to malfunction. Avoid placing the phone over the pacemaker, i.e. in your breast pocket. When using the phone, place it at your ear opposite the pacemaker. If a minimum distance of 15 cm is kept between the phone and the pacemaker, the risk of interference is limited. If you have any reason to suspect that interference is taking place, immediately turn off your phone.

Contact your cardiologist for more information.

Some hearing aids might be disturbed by mobile phones. In the event of such disturbance, you may want to consult your service provider, or call the customer services line to discuss alternatives.

Aircraft

- Turn off your mobile phone before boarding any aircraft.
- Do not use it on the ground without crew permission.

To prevent interference with communication systems, you must not use your mobile phone while the plane is in the air.

Blasting Areas

Turn off your mobile phone when in a blasting area or in areas posted “turn off two-way radio” to avoid interfering with blasting operations. Construction crews often use remote control RF devices to set off explosives.

Potentially Explosive Atmosphere

Turn off your mobile phone when in any area with a potentially explosive atmosphere. It is rare, but your phone or its accessories could generate sparks. Sparks in such areas could cause an explosion or fire resulting in bodily injury or even death.

Areas with a potentially explosive atmosphere are often, but not always, clearly marked. They include fuelling areas, such as petrol stations, below deck on boats, fuel or chemical transfer or storage facilities, and areas where the air contains chemicals or particles, such as grain, dust, or metal powders.

Do not transport or store flammable gas, liquid, or explosives in the compartment of your vehicle, which contains your mobile phone and accessories.

Power Supply

- Connect AC (Power supply) only to designated power sources as marked on the product.
- To reduce risk of damage to the electric cord, remove it from the outlet by holding onto the AC adapter rather than the cord.
- Make sure the cord is positioned so that it will not be stepped on, tripped over or otherwise subjected to damage or stress.
- To reduce risk of electric shock, unplug the unit from any power source before attempting to clean it.
- The charger must not be used outdoors or in damp areas.
- Please note that the enclosed charger (Standard charger CST-10) is not compatible with the Deskstand CDT-10.

Children

Do not allow children to play with your mobile phone since it contains small parts that could become detached and create a choking hazard.

Emergency Calls IMPORTANT!

This phone, like any mobile phone, operates using radio signals, cellular and landline networks as well as user-programmed functions, which cannot guarantee connection under all conditions. Therefore you should never rely solely upon any mobile phone for essential communications (for example medical emergencies).

Remember, in order to make or receive calls the phone must be switched on and in a service area with adequate cellular signal strength. Emergency calls may not be possible on all cellular phone networks or when certain network services and/or phone features are in use. Check with your local service provider.

Battery Information

New Batteries

The battery delivered with your phone is not fully charged.

Battery Use and Care

A rechargeable battery has a long service life if treated properly. A new battery, or one that has not been used

for a long period of time could have reduced capacity the first few times it is being used.

- The talk and standby times depend on the actual transmission conditions when using the phone. If the phone is used nearby a base station less power is required and talk and standby times are prolonged.
- Use only Ericsson original batteries and the AC/DC adapter supplied with your battery charger. Using non original Ericsson accessories could be dangerous and the warranty does not cover product failures which have been caused by use of non-Ericsson original accessories.
- Do not expose your battery to extreme temperatures, never above +60°C (+140°F). For maximum battery capacity use your battery in room temperature. If the battery is used in cold temperatures the battery capacity will be reduced.
- The battery can only be charged when the temperature is between +5°C (+41°F) and +45°C (+113°F).
- Turn off your phone before removing the battery.
- Use only the battery for the intended purpose.
- Do not attempt to take a battery apart.
- Do not let the metal contacts on the battery touch another metal object. This could short-circuit and damage the battery.
- Do not expose a battery to open flames. This could cause the battery to explode.
- Do not expose a battery to liquid.

- Do not allow the battery to be placed into the mouth. Battery electrolytes may be toxic if swallowed.

Recycling Your Battery

The battery must be disposed of properly and should never be placed in municipal waste. Check local regulations for proper disposal instructions.

Warranty

Thank you for purchasing this Ericsson Product. To get maximum use of the features of your new product we recommend that you follow a few simple steps:

- Read the Guidelines for safe and efficient use.
- Read all the terms and conditions of your Ericsson Warranty.
- Save your original receipt. You will need it for warranty repair claims. Should your Ericsson Product need warranty service, you should return it to the dealer from whom it was purchased or contact your local Ericsson helpdesk to get further information.

Our Warranty

Ericsson warrants this Product to be free from defects in material and workmanship at the time of its original purchase by a consumer, and for a subsequent period of one (1) year.

All accessories for the Product are covered by a warranty for a period of one (1) year from the date of its original purchase by a consumer.

What We Will Do

If, during the warranty period, this Product fails to operate under normal use and service, due to improper materials or workmanship, Ericsson subsidiaries, authorised distributors or authorised service partners

will, at its option, either repair or replace the Product in accordance with the terms and conditions stipulated herein.

Conditions

1. The warranty is valid only if the original receipt issued to the original purchaser by the dealer, specifying the date of purchase and serial number, is presented with the product to be repaired or replaced. Ericsson reserves the right to refuse warranty service if this information has been removed or changed after the original purchase of the product from the dealer.
2. If Ericsson repairs or replaces the Product, the repaired or replaced Product shall be warranted for the remaining time of the original warranty period or for ninety (90) days from the date of repair, whichever is longer. Repair or replacement may be via functionally equivalent reconditioned units. Replaced faulty parts or components will become the property of Ericsson.
3. This warranty does not cover any failure of the Product due to normal wear and tear, misuse, including but not limited to use in other than the normal and customary manner, in accordance with Ericsson's instructions for use and maintenance of the Product, accident, modification or adjustment, acts of God, improper ventilation and damages resulting from liquid.
4. This warranty does not cover product failures due to repair installations, modifications or improper service performed by a non-Ericsson authorised service

workshop or opening of the product by non-Ericsson authorised persons.

5. The warranty does not cover product failures which have been caused by use of non-Ericsson original accessories.
6. Tampering with any of the seals on the products will void the warranty.
7. THERE ARE NO OTHER EXPRESS WARRANTIES, WHETHER WRITTEN OR ORAL, OTHER THAN THIS PRINTED LIMITED WARRANTY. ALL IMPLIED WARRANTIES, INCLUDING WITHOUT LIMITATION THE IMPLIED WARRANTIES OR MERCHANTABILITY OR FITNESS FOR A PARTICULAR PURPOSE, ARE LIMITED TO THE DURATION OF THIS LIMITED WARRANTY. IN NO EVENT SHALL ERICSSON BE LIABLE FOR INCIDENTAL OR CONSEQUENTIAL DAMAGES OF ANY NATURE WHATSOEVER, INCLUDING BUT NOT LIMITED TO LOST PROFITS OR COMMERCIAL LOSS. TO THE FULL EXTENT THOSE DAMAGES CAN BE DISCLAIMED BY LAW.

Some countries do not allow the exclusion or limitation of incidental or consequential damage, or limitation of the duration of implied warranties, so the preceding limitations or exclusions may not apply to you. This warranty gives you specific legal rights, and you may also have other rights which may vary from country to country.

Declaration of Conformity

We, **Ericsson Mobile Communications AB of Nya Vattentorget 221 83 Lund, Sweden**

declare under our sole responsibility that our product

Ericsson type 110 1501-BV

to which this declaration relates is in conformity with the appropriate standards TBR 19, 20, 31 and 32, ETS 300 342-1 and EN 60950, following the provisions of, Radio & Teleterminals directive 99/5/EC with requirements covering EMC directive 89/336/EEC, and Low voltage directive 73/23/EEC.

Lund 2000-03-28

Place & date of issue

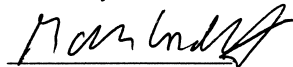

Mats Lindoff, Executive Vice President

CE 0682

Not for Commercial Use

Index

A

- Accept calls 48
- Alarm clock 53
 - set time 53
 - turn off 53
- Alarm indicator 66
- Alarm signal 53
- Alphabets
 - choosing 17
- Answering a call 11
- Answering mode 29
- Answering service. See Voice mail service
- Area information 35
 - receiving area messages 35
- Ask to save 19
- Assembling the phone 4

B

- Barring calls. See Restrict calls
- Battery 7
 - attaching 6
 - charging 7
 - disconnecting the charger 8

- Battery indicator 66
- Bookmarks 59
 - add a bookmark 59

C

- Calculator 53
- Call barring. See Restrict calls
- Call cost 43
 - setting a credit limit 44
 - setting a price per call unit 43
- Call divert
 - divert indicator 66
 - turn off 39
 - turn on 39
- Call forwarding. See Call divert
- Call list 23
 - call number 23
 - missed calls 23
- Call restrictions. See Restrict calls
- Call time 43
- Call waiting service 40
 - turn off 40
 - turn on 40
- Calling card service 49
- Calling card services
 - activating 49

- Calling Line Identification (CLI) service 10

Calls

- answering 11
 - conference 41
 - emergency 10
 - ending 9
 - hiding your number 11
 - international 10
 - making 9
 - putting on hold 40, 41
 - receiving 10
 - re-dialling 9
 - rejecting 11
 - showing your number 11
 - switching between calls 41
- Cell information 35
 - Changing phone lines 48
 - Charger
 - disconnecting 8
 - Charging the battery 7
 - Choosing a calling card 49
 - Clock. See Time
 - Closed user groups 47

Conference calls 41
 adding a participant 41
 extracting a participant 42
 releasing a participant 42
 releasing all participants 42
 setting up 41

Credit card calls 49
 making a call 50
 saving a number 49

D

Date 28, 29
 setting 29

Display
 help texts 15
 light 27
 start up/shut down show 29

Display language 15

Divert calls
 turn off 39
 turn on 39

Divert indicator 66

E

Earpiece volume 9
E-Maze 55

Emergency calls 10
Emergency numbers 10
Ending a call 9
Erix 55

F

Fax
 sending and receiving 52

Fixed dialling 46
 turn on 47

Fixed numbers 47
 storing 47

Forwarding calls. See Call divert

G

Games 54
 E-Maze 55
 Erix 55
 Tetris 54
Groups. See Phone book

H

Handsfree 29
Help texts 15
Hiding your number 11

I

Int. emergency number 10
International calls 10

K

Key functions 12, 13
 quick keys 67
Key sound 27
Keypad 3
Keypad lock 27
 automatic 27
 manual 27
 unlock 28

L

Language in display 15
Letters
 entering 17
Line
 choosing a line 48

M

Making a call 9
Master reset 30
Menus 13
 display text 14
 leave a menu 13

- moving (scroll) through 13
- select a menu 13
- shortcuts 14
- Message signal 27
- Messages. See Text messages
- Microphone
 - muting 9
 - turning off 9
- Minute minder 27
- Missed calls 23
- Muting the microphone 9
- My shortcuts 28
 - add function 28
 - remove function 28

N

- Network 50
 - preferred 50
 - search modes 51
 - selecting 50
- Notepad 11

O

- Online services 61
- Open a homepage 57
- Open a WAP page 57

P

- Personal ring signal 26
- Phone
 - turn off 9
 - turn on 8
- Phone book 18
 - ask to save 19
 - calling from 18
 - card memory 20
 - checking the memory 21
 - delete a phone number 20
 - edit a name 20
 - edit a phone number 20
 - groups 21
 - memory 20
 - overwrite protection 21
 - phone memory 20
 - save a number 18
 - shortcuts 19
 - sort order 20
- Phone lock
 - activating/cancelling 46
 - auto lock 45
 - changing the security code 45
 - on 45

PIN

- changing 45

PIN2

- changing 45

Plus sign (+)

- 10

Profiles

- selecting 36

PUK

- 44

Q

- Quick keys 67

R

- Reading a message 33
- Receiving a call 10
- Re-dialling 9
 - automatic 9
- Rejecting a call 11
- Request reply (SMS) 32
- Restrict calls 46
 - changing password 46
 - changing status 46
- Ring signal
 - choosing 25
 - compose own melody 26
 - increasing ring 25

message signal 27
personal 26
turn off 25
volume 27

S

Save a number 18
Scroll 12
Send a message 31
Service centre 31
Shortcuts 14
Showing your number 11
Silent ring signal 25
SIM card
 inserting 5
 resetting 62
 unblocking 44
Sim card 4
SIM card lock
 activating/cancelling 45
SMS. See Text messages
Switching between two calls 41

T

Tetris 54

Text messages
 call phone number 34
 deleting 34
 forwarding 34
 message types 32
 reading 33
 reply requested 32
 replying 33
 saving 34
 sending 31
Time 28
 automatic time zone 29
 format 28
 setting the time 28
Tone signals
 turn off 11
Turn off microphone 9
Turning phone off 9
Turning phone on 8

V

Voice control
 answering 37
 dialling 37
 rejecting 37

Voice mail service 24
 call 24
 save number 24
Volume
 earpiece 9
Volume keys 11, 12

W

WAP 55
 bookmarks 59
 entering WAP settings 56
 open a homepage 57
 open a WAP page 57
 preparing the phone 56
WAP profiles 60