



# Mobile Phone SH 888

## User's Guide

GSM 900/1800 Dual Band

ERICSSON 

# Contents

<b>General Information</b> .....	2	<b>The Mobile Office Suite</b> .....	33
Operators & Subscription, GSM 900/1800 Dual Band, SIM & PIN		Installing the Mobile Office Suite, Uninstalling the Mobile Office Suite	
<b>Preparing Your Phone for Use</b> .....	3	<b>Networks</b> .....	35
The SIM Card, The Battery		Search Mode, Selecting a Network, List of Preferred Networks	
<b>Turning On the Phone</b> .....	7	<b>Security</b> .....	38
When No Network Name Is Displayed, To Turn Off the Phone, Initial Settings		The Card Lock, The Phone Lock, Call Barring, The Keypad Lock, Fixed Dialling	
<b>Making and Receiving Calls</b> .....	9	<b>Diverting Incoming Calls</b> .....	42
Emergency Calls, Making Calls, Receiving a Call, Redialling a Number, Calling Someone Who Has Called You, Unanswered Calls, Hiding or Showing Your Number		Activating a Call Divert, Diverting when the Data Menus are On, Checking the Divert Status, Cancelling Call Diverts	
<b>During a Call</b> .....	13	<b>Handling More than One Call</b> .....	44
To Change the Earpiece Volume, To Mute the Microphone, To Use the Display as a Scratch Pad, To Send Tone Signals		The Call Waiting Service, Receiving a Second Call, Receiving a Third Call, To Make a Second Call, Connecting Two Calls – Explicit Call Transfer, Conference Calls	
<b>The Menu System</b> .....	14	<b>Handsfree Calling</b> .....	47
Moving through the Menu System, Display Text and Symbols		Selecting Answering Mode, Other Handsfree-Related Settings	
<b>The Phone Book</b> .....	15	<b>Personalizing Your Phone</b> .....	48
Before You Start, Entering Characters, Creating Your Personal Phone Book, Recalling a Phone Number, Keeping Your Phone Book Up to Date, Copying Phone Numbers between Positions and Memories		Personal Settings, The Ring Signal Level, Time and Date	
<b>Sending and Receiving Text Messages</b> .....	21	<b>Other Useful Features</b> .....	52
Two Memories, Setting the Phone for Text Messaging, Composing and Sending Messages, Reading a Message, Replying to a Message, Erasing a Message, Storing a Received Message, Reading Stored Messages, Calling a Phone Number in a Message, Frequently Used Messages		The Answering Service, The Call Time/Call Cost, The Two Line Service, Calling Card or Credit Card Calls, Area Information, The Alarm, The Calculator	
<b>Communicating via the Modem</b> .....	26	<b>Guidelines for Safe and Efficient Use</b> .....	59
Before you Start, The Data Menus, Installing the Infrared Modem, To Connect Using the IR Link, To Connect Using the RS232 Cable, Making Fax and Data Calls, Receiving Fax and Data Calls		<b>Warranty Conditions</b> .....	62

# The Menu System

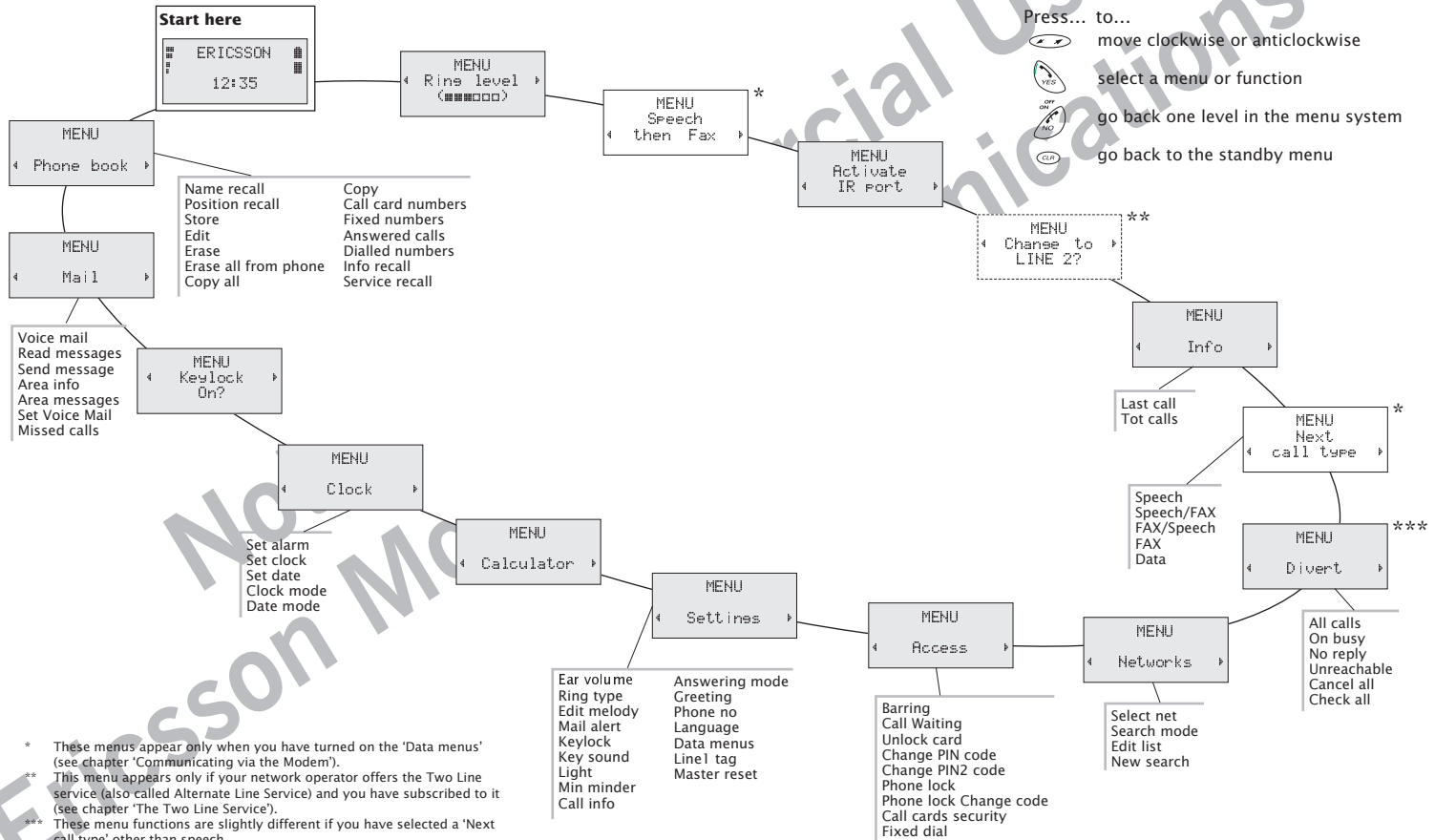

# The Phone, Keypad and Display



## Key Functions



**YES**, used to:

- make calls, answer incoming calls, put calls on hold and switch between calls.
- confirm selections and inputs.
- enter a selected menu.



**ON/OFF** and **NO**, used to:

- turn the phone on or off.
- end calls, reject incoming calls and cancel selections.
- back up one level in the menu system.



**NAVIGATION KEY**, press **LEFT** or **RIGHT** (or press and hold) to access and move through the menu system.



**CLR** (Clear), used to

- erase digits from the display.
- mute the telephone.
- return to standby from the menu system.



**NUMERIC KEYS**, used to enter the digits 0–9 and to enter text. The 0 key also enters the international prefix (+) if held down.



**STAR**, used to:

- enter the \* character.
- enter a pause character (P) if held down.



**HASH**, used to:

- enter the characters # or #.
- recall a phone number from the Phone Book.



**VOLUME KEYS** on the side of the phone, used to:

- change the earpiece volume during a call.
- reject an incoming call, if pressed twice.

## Indicators in the Display



**Signal strength.**

The more bars that are shown, the higher the signal strength.



**Battery meter.**

The fuller the icon, the more power there is.



The keypad is locked.



All incoming calls are diverted to another number.



The ring signal is turned off.



You have received a text message.



You have received a voice mail.



The alarm is set.



The line currently selected. (Requires that you have the Two Line Service.)

# Congratulations...

...and thank you for choosing the SH 888, a mobile phone specially suited for the demanding user of communication tools. Retaining the slim, streamlined size that has become associated with the Ericsson family of phones, the SH 888 sets a new standard for others to follow.

Apart from its unique toughness and extraordinary sound quality, the SH 888 comes packed with features that will help you stay ahead. These are just some of the highlights:

- With the in-built modem, you can forget all about PC Cards. It is already inside your phone, guaranteeing you instant access to your PC, laptop or handheld communicator. Wireless if you prefer, thanks to its infrared capabilities.
- Dual band operation extends the potential for efficient network usage. Especially if you frequently use your phone in urban areas or travel abroad.

Like the other phones from Ericsson, the SH 888 is produced to meet the highest quality standards.

This guide introduces you to your SH 888 and shows you how to get the most out of it. Before you start, please read the 'Guidelines for Safe and Efficient Use'.

Please note that some of the functions and services described in this user's guide are depending on your choice of network operator. Should you need additional information on how to use them, contact your operator.

## Mobile Internet

When you are on the move and in need of communication and information, Mobile Internet is the answer.

Mobile Internet is a service supplied by Ericsson to facilitate easy communications and rapid information retrieval, wherever you are. It gives you access to on-line customer services, on-line user manuals, and useful information when you are out travelling. It allows you to download various communication software which will ensure you achieve optimum results from your Ericsson products.

If you run into any problems, there are help texts connected to the different Mobile Internet pages.

The Internet address to Mobile Internet is **<http://mobile.ericsson.com/mobileinternet>**

To get access to the service you also need a user id and a password. The first time you log on, please use the following:

User Id: **mobile**

Password: **internet**

Note that you must change user id and password the first time you log on to Mobile Internet.

# General Information

## Operators & Subscription

To be able to use your phone, you need to have a subscription to a network. This is obtained from the network operator.

The services included in your subscription depend on your choice of operator and/or subscription. Therefore, some of the services and functions described in this manual may not be accessible to you. If you want a complete list of the services included in your subscription, please contact your network operator.

## GSM 900/1800 Dual Band

The Ericsson SH 888 is a dual band phone, which means that you can use your phone in two different kinds of networks – the GSM 900 and the GSM 1800 (also called PCN or DCS 1800) systems.

The GSM 1800 system is practically the same as the GSM 900 system. The difference between the two is that they use different frequencies. GSM 900 uses 900 MHz frequency, whereas GSM 1800 uses 1800 MHz.

A dual band phone that combines the two standards can use both frequencies. This considerably increases capacity in densely populated urban areas, and consequently improves the coverage offered by your network operator. It will also offer you enhanced international roaming, thanks to the additional networks now available when you are out travelling.

The switching between the two systems is done automatically and seamlessly, which means that you can use your phone without ever having to consider which

system is best at the time. This is taken care of by the networks. However, you should note that the functions offered and the network coverage differ depending on your choice of operator and/or subscription.

## SIM & PIN



You will obtain a SIM (Subscriber Identity Module) card with your subscription. The SIM card contains a computer chip that keeps track of your phone number, the services you have ordered from your network operator and your Phone Book information, among other things.

Your SIM card is supplied with a security code or PIN (Personal Identity Number), which you need in order to gain access to the network. Your PIN may also be required when you want to change settings in your phone. Furthermore, some operators may have services that require a second PIN, your PIN2. You will find your PIN (and PIN2) in the information from your operator.

Every time you turn on your phone, it prompts you to enter your PIN. If the PIN is entered incorrectly three times in a row, the SIM card will be blocked. If this happens you can unlock it by using your PUK (Personal Unblocking Key code), which you also get from your operator.

You should be careful with your PIN, since it is your protection against unauthorized use of your phone and subscription.

Press  to enter the menu system. See inside the cover.

# Preparing Your Phone for Use

## The SIM Card

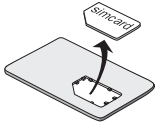

When you register as a subscriber with a network operator, you obtain a SIM card.

SIM cards come in two sizes. One is the size of a credit card, and the other is considerably smaller (about the size of a regular stamp). The SH 888 uses the smaller card. Many operators deliver credit card sized SIM cards which have a perforated smaller card that you can take out easily.

Before you can use your phone, you must insert the SIM card into the phone.

### To Insert the SIM Card

To insert the SIM card, remove the battery (if attached) and follow these steps:

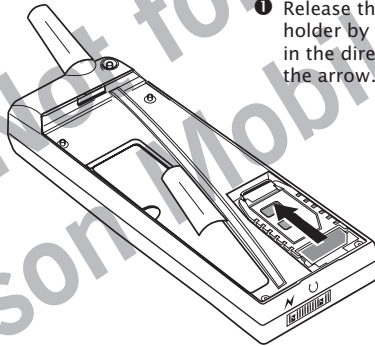

- 1 Release the SIM card holder by sliding it in the direction of the arrow.

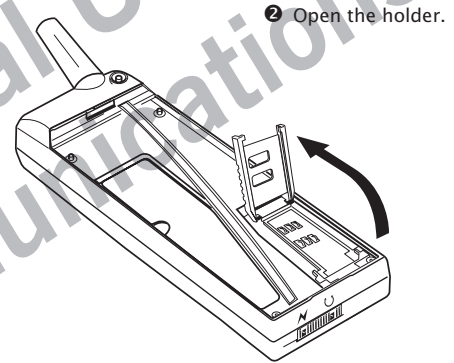

- 2 Open the holder.

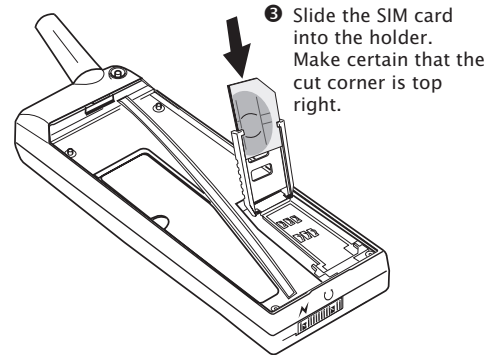

- 3 Slide the SIM card into the holder. Make certain that the cut corner is top right.

Press  to enter the menu system. See inside the cover.

4 Close the holder.

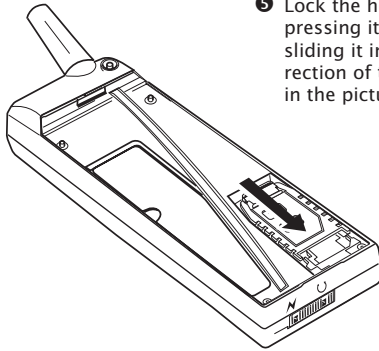

5 Lock the holder by pressing it down and sliding it in the direction of the arrow in the picture.

## The Battery

Your mobile phone comes with a nickel metal hydride (NiMH) battery. The battery is not charged when you buy your phone, but there may be enough power to turn on the phone. We recommend that you charge the battery before you use the phone.

### To Attach the Battery to the Phone:

- 1 Place the battery on the back of the phone.
- 2 Press the battery upwards and against the phone until it snaps into place.

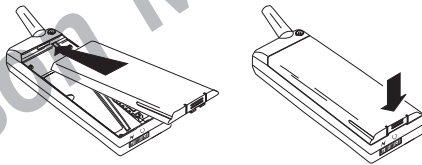

### To Remove the Battery

Make sure that the phone is turned off before removing the battery (see next chapter). Then:

- 1 Press the catch on the bottom of the battery.

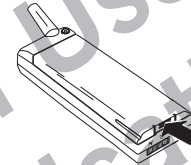

- 2 Lift the battery up and away from the phone.

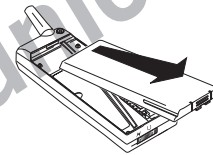

### To Charge the Battery

Make sure that the battery is attached to the phone. Then:

- 1 Connect the charger to the mains. (The box may contain more than one mains plug. In this case, use the one that fits the wall socket.)

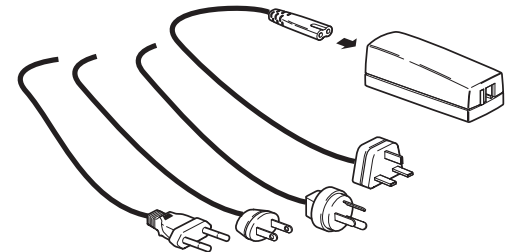

Press  to enter the menu system. See inside the cover.



A green indicator on the charger lights up. If not, make sure you have put the plug into the charger correctly. (You may have to press hard.)

- 2 Connect the clear plastic plug on the charger cable to the charger. It is correctly inserted when it snaps into place.

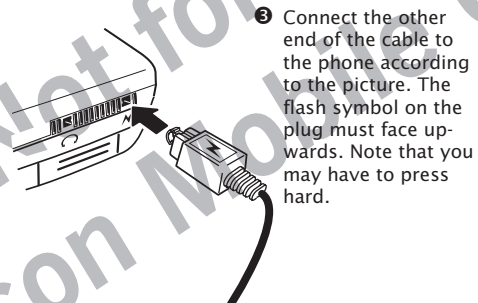
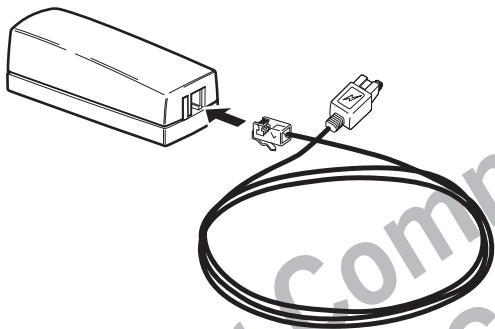

- 3 Connect the other end of the cable to the phone according to the picture. The flash symbol on the plug must face upwards. Note that you may have to press hard.

The phone will automatically start charging the battery when you attach the charger. To indicate charging:

- the battery meter in the display is continuously filled and emptied.
- the indicator on top of the phone shows a steady red light (green, if the phone is turned on).

When the battery is fully charged, the battery meter in the display will show full and the indicator on top of the phone will show a steady green light.

**Note!** It is possible to use the phone while the battery is being charged. This will, however, increase the charging time.

### To Disconnect the Charger

- Twist the plug connected to the phone upwards and pull it out.

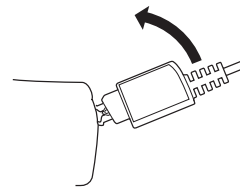

### When to Charge the Battery

The nickel metal hydride battery that comes with your phone can be charged whenever you wish without losing performance. This is *not* the case with the cheaper nickel cadmium type batteries, often sold as accessories from other suppliers. For optimal talk and standby time in the long run, we recommend that you only use Ericsson original batteries with your SH 888.

To remind you that the battery will soon need to be charged or replaced with a charged one:

- an alarm signal (a long beep) sounds and the message 'Battery low' appears for ten seconds in the display.
- the indicator light on top of the phone starts blinking red.

**Note!** If the phone is left turned on, the low battery alarm will be repeated several times and, finally, the phone will turn itself off when the battery is no longer able to power it satisfactorily. It might be possible to turn the phone on again, but you will not be able to make or receive any calls. You should charge the battery or replace it with a charged one.

# Turning On the Phone

To turn on the phone:

- 1 Press and hold down the **NO** (ON/OFF) key until you hear a click. The display prompts you to enter your PIN.
- 2 Enter your PIN. The digits appear as stars in the display. If you make a mistake while entering your PIN, erase the wrong digit by pressing the **CLR** key.
- 3 Press **YES**.



Enter  
PIN  
\*\*\*\*



ERICSSON

If you enter your PIN correctly, 'ERICSSON' will appear in the display. The phone will then search for a network.

## Note!

If your PIN is entered incorrectly three times in a row, the SIM card will be blocked and you will have to unblock it using your PUK code. See chapter 'Security'.

When a network is found, the phone beeps three times. The indicator light on top of the phone flashes green once every second and your network operator's name (in most cases abbreviated) is shown in the display. If you have the charger connected, the indicator will show a steady green light instead of a flashing one.

You can now make and receive calls. This is called standby mode.

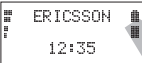

ERICSSON  
12:35

## When No Network Name Is Displayed

If the message 'Emergency calls only' is displayed, you are within range of a network but you are not allowed to use it. However, in an emergency, you can call the international emergency number 112. See chapter 'Making and Receiving Calls'.

Press  to enter the menu system. See inside the cover.

If the message 'No network' is displayed, there is no network within range or the received signal is too weak. You have to move to obtain a sufficiently strong signal.

## To Turn Off the Phone

- In standby mode, press and hold the **NO** (ON/OFF) key until the display is turned off.

## Initial Settings

The first time you turn on your SH 888, you may want to change the default language and ring level settings, and set the clock.

### Display Language

Most modern SIM cards automatically set the display language to the language of the country where you bought your SIM card. If this is not the case, the default language is English.

To change the display language:

- 1 Press the navigation key **LEFT** or **RIGHT** until the 'Settings' menu appears.
- 2 Press **YES** to enter the 'Settings' menu.
- 3 Press the navigation key to the **LEFT** until the 'Language' menu appears.
- 4 Press **YES** to enter the 'Language' menu.
- 5 Press the navigation key until you find the desired language.
- 6 Press **YES** to select the language.

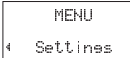

MENU  
← Settings →

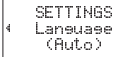

SETTINGS  
← Language (Auto) →

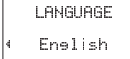

LANGUAGE  
← English →

- 7 Press **CLR** to return to standby mode.

**Note!** If by accident you end up with your phone displaying a language you do not understand, you can return to English by pressing **LEFT** 0000 **RIGHT** at any time.

## Setting the Time

The time is shown at the bottom of the display. When you buy your phone, the time is normally not set.

If you want to set the time:

```
MENU
<  Clock  >
```

```
CLOCK
< Set clock
  (16:36) >
```

```
SET CLOCK
< (16:36)
  11:45  >
```

- 1 Press the navigation key **LEFT** until the 'Clock' menu appears.
- 2 Press **YES** to enter the 'Clock' menu.
- 3 Press the navigation key **RIGHT** until the 'Set clock' menu appears.
- 4 Press **YES** to enter the 'Set clock' function.
- 5 Enter the correct time in hours and minutes and press **YES**.
- 6 Press **CLR** to return to standby mode.

**Note!** The time is by default presented in the 24-hour format. If you prefer the 12-hour format, you can change the default setting.

For more information, see 'Personalizing Your Phone'.

## To Set the Ring Signal Level

- 1 Press the navigation key **RIGHT**.  
The text 'Ring level' and a bar representing the ring signal level appears in the display.
- 2 Press **YES** to enter the 'Ring level' menu.
- 3 Use the navigation key to set the ring signal level.
  - Pressing **RIGHT** increases the volume.
  - Pressing **LEFT** decreases the volume.

The phone rings once with the actual setting as you press the navigation key, except for the 'Off' and 'Step' settings.

- 4 Press **YES** to save the setting.
- 5 Press **CLR** to return to standby mode.

**Tip!** Use the volume keys on the side of the phone to change the ring level silently.

**Note!** If you have your SH 888 connected to external equipment (for example handsfree equipment or a vibrating call alert device), the ring signal level will be set for this situation separately. See 'Personalizing Your Phone' for more information.

# Making and Receiving Calls

The instructions in this chapter assume that you have turned on your phone and that you are within range of a network.

## Emergency Calls

To make an emergency call:

- 1 If the phone is not on, turn it on by pressing the **NO** key until you hear a click.
- 2 Enter 112 (the international emergency number).
- 3 Press **YES**. The display shows 'Emergency'.

**Note!** Some operators may require that a SIM card has been inserted into the phone and, in some cases, that the PIN has been entered as well.

## Making Calls

### Domestic Calls

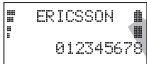

- 1 Enter the area code and phone number. The digits are shown in the display.
  - If you need to erase a digit, press **CLR**.
  - To erase all digits, press and hold the **CLR** key until all digits have been erased.

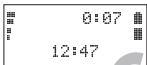

- 2 Press **YES** to make the call. The display shows 'Calling', followed by 'Connecting'.
  - When the call is answered, a call time meter in the display shows how long you have been on the phone in minutes and seconds.
  - If nobody answers your call or you cannot get through, press **NO**. The number is stored in a



**Tip!** It is possible to check the duration of the call later on. See 'Other Useful Features'.

### International calls

- 1 Press and hold the 0 key until '+' is displayed. The (+) will automatically be replaced by the international dialling prefix for the country you are calling from.
- 2 Enter the country code, the area code (without any leading zero) and the phone number.
- 3 Press **YES** to make the call.

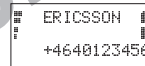

**Note!** When you are abroad, your phone will automatically search for a network that you are allowed to use. Which networks you can use depends on the agreements your operator has signed with the operators in the country you are visiting. See chapter 'Networks'.

### Checking the first characters

If you have entered more characters than can be seen in the display, the first characters will be replaced by the  $\oplus$  symbol. To check the first characters:

- press the navigation key **RIGHT**.

Press  to enter the menu system. See inside the cover.

## Receiving a Call

When you receive a call, the phone rings and the indicator light on top of the phone blinks green rapidly. The display shows 'Answer?.'

If your subscription includes the Calling Line Identification service and the caller's network sends the number, you will see the caller's number at the bottom of the display. If the number is stored with a name in the phone book, the name will be shown in the display.

**Note!** The phone must be turned on and within coverage of a network before a call can be received.

### To Answer the Call

- 1 Press **YES**.
- 2 When the call is finished, press **NO**.

**Tip!** To mute the ring signal when you receive a call, press **CLR**.

### To Reject the Call

There are two ways of rejecting the call:

- Press the **NO** key.
- Press the volume key on the side of the phone twice.

The caller will hear a busy tone if the caller's network supports this function. If 'Divert on busy' is activated, the incoming call is diverted to the number you have specified (see 'Diverting Incoming Calls').

## Redialling a Number

Your SH 888 conveniently lets you redial the last phone numbers you have called (15 or more, depending on your SIM card). It can also redial a number automatically if the connection failed when you first called.

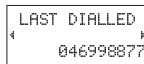

LAST DIALLED  
046998877

## To Redial Previously Called Numbers

- 1 Press **YES**. The display now shows the last dialled number.
- 2 Press the navigation key **RIGHT** or **LEFT** until the number you want to call is shown on the bottom row of the display.
- 3 Press **YES** to make the call.

**Note!** If you want to clear the last dialled numbers memory, do the following:

- 1 Press the navigation key **LEFT**. The 'Phone book' menu appears.
- 2 Press **YES** to enter the 'Phone book' menu.
- 3 Press the navigation key **LEFT** until the 'Dialled numbers' function appears.
- 4 Press **YES** to select the 'Dialled numbers' function.
- 5 Press and hold the **CLR** key. The question 'Erase all?' appears.
- 6 Press **YES** to erase the last dialled numbers from the memory.
- 7 Press **CLR** to return to standby mode.

## The Automatic Redialling Function

If the connection fails and the receiver's network supports it, the display shows 'Retry?' on the top row and the reason for the failure on the second row.

To redial the number automatically:

- Press **YES**.
  - The number will automatically be redialled until the call is answered, up to 10 times.
  - If you press any key or receive a call, the redialling will be interrupted.
  - If the redialling is successful, the phone will beep and then you will hear a ring signal.

If you do not want to retry, press **NO**.

## Calling Someone Who Has Called You

If you subscribe to the Calling Line Identification service, and the caller's network sends the number, the numbers of the last ten answered calls are stored in the phone.

```
MENU
├ Phone book ┤
```

```
ANSWERED 1
├ +1234567890 ┤
```

```
ANSWERED 1
├ +1234567890 ┤
```

To recall one of the last ten answered numbers:

- 1 Press the navigation key to the **LEFT**. The 'Phone book' menu appears.
- 2 Press **YES** to enter the 'Phone book' menu.
- 3 Press the navigation key **LEFT** repeatedly until the 'Answered calls' function appears.
- 4 Press **YES** to select the 'Answered calls' function.
- 5 Press the navigation key until you find the number you want.
- 6 Press **YES** to make the call.

To clear the answered calls memory:

- 1 Press the navigation key to the **LEFT**. The 'Phone book' menu appears.
- 2 Press **YES** to enter the 'Phone book' menu.
- 3 Press the navigation key **LEFT** repeatedly until the 'Answered calls' function appears.
- 4 Press **YES** to select the 'Answered calls' function.
- 5 Press **CLR**. The question 'Erase all?' appears.
- 6 Press **YES**.

## Unanswered Calls

```
ERICSSON
Calls:2
13:52
```

If you have received calls but have been unable to answer, the number of unanswered calls will be shown in the display until you press **CLR**.

Information about the ten last missed calls is saved in your phone's memory, which makes it possible for you to check when the calls were received. If your subscription includes the Calling Line Identification service and

the caller's network sends the number, you can also find out who called.

```
MENU
├ Mail ┤
```

```
MISSED CALLS
├ 13:25 ┤
├ 0246193000 ┤
```

```
MISSED CALLS
├ 14-07-97 ┤
├ Unidentified ┤
```

## To Find Out Who Called and When

- 1 Press the navigation key to the **LEFT** repeatedly until the 'Mail' menu appears.
- 2 Press **YES** to enter the 'Mail' menu.
- 3 Press the navigation key repeatedly until the 'Missed calls' function appears.
- 4 Press **YES** to enter the 'Missed calls' function.
- 5 The last caller's number (if your subscription includes the Calling Line Identification service) is now shown in the display together with the time (or date) when the call was received. If no information about the caller's number was received, the display will show one of the following:
  - 'Unidentified', which means that no information was available.
  - 'Restricted', which means that the caller wanted to withhold the number.
- 6 To see your other unanswered calls, press the navigation key repeatedly.
- 7 Press **CLR** to return to standby mode.

**Note!** If you check a missed call within 24 hours, the time of the call is displayed. Otherwise, the time is replaced by the date. You can toggle between date and time by pressing \*.

## To Erase a Number from the Missed Calls Memory

- 1 When the information about the call is shown, press **CLR**.
- 2 Press **YES**.

## Hiding or Showing Your Number

With most common subscriptions, the caller's number is sent when a call is made. This means that the receiver can see your phone number when you make a call. However, some operators offer subscriptions where your phone number is normally hidden.

If you want to change the setting for a particular call, this is possible provided the network you use supports it.

### To Hide Your Phone Number for a Particular Call

- 1 Enter the phone number you wish to call.
- 2 Press the navigation key **RIGHT**.  
The 'Special functions' menu now appears.
- 3 Press **YES** to enter the 'Special functions' menu.
- 4 Press the navigation key repeatedly until 'Hide Id' appears.
- 5 Press **YES** to make the call.

```
MENU
Special
functions
```

```
SPECIAL FUNC
Hide Id
```

### To Show Your Number for a Particular Call

- 1 Enter the phone number you wish to call.
- 2 Press the navigation key **RIGHT**.  
The 'Special functions' menu now appears.
- 3 Press **YES** to enter the 'Special functions' menu.
- 4 Press the navigation key until 'Send Id' appears.
- 5 Press **YES** to make the call.

```
MENU
Special
functions
```

```
SPECIAL FUNC
Send Id
```



# During a Call

Your SH 888 has several functions which you might find helpful while you are on the phone.

## To Change the Earpiece Volume



If you want to change the earpiece volume during a call:

- Press the volume keys on the side of the phone up or down.
  - Pressing **UP** increases the volume.
  - Pressing **DOWN** decreases the volume.

See also 'Personalizing Your Phone'.

## To Mute the Microphone

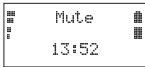

To mute the microphone temporarily during a call:

- 1 Press and hold the **CLR** key. 'Mute' is shown in the display.
- 2 To resume conversation, release the **CLR** key.

## To Use the Display as a Scratch Pad

If you need to write down a phone number during a call, you can use the Scratch Pad function in the SH 888. To do this:

- Enter the number using the numeric keys.

When you end the call, the number remains in the display. You can now call the number by pressing **YES** or save it in the Phone Book (see chapter 'The Phone Book').

**Note!** If you press any numeric key while on the phone, the person on the other end of the line will hear a tone.

## To Send Tone Signals

To use telephone banking services or control a phone answering machine, you need to use codes. These codes are sent as tone signals (also known as DTMF tones or touch tones).

To send tone signals/codes during a call:

- Press the appropriate keys (0-9, \* and #).

**Tip!** You can also save the code together with a number in the Phone Book. See 'Creating Your Personal Phone Book' in the 'Phone Book' chapter on how to do this.

**Note!** If you send tone signals while on the phone, the person on the other end of the line will hear the tones.

# The Menu System

The menu system of your SH 888 allows you to control the phone's functions and to customize it to suit your personal preferences.

Each menu contains a list of options; some of these have submenus with additional options.

To help you find your way around the menus, we recommend that you use the fold-out on the inside of the cover.

## Moving through the Menu System

The menus are arranged in a continuous loop (see the fold-out), which you move through with the NAVIGATION, **YES**, **NO** and **CLR** keys.

Press... to...



move clockwise or anticlockwise.



select a menu or a function.



go back one level in the menu system and/or leave a setting unchanged.



go back to the standby menu.

To select a menu or make a setting:

- 1 Press the navigation key **LEFT** or **RIGHT** until you reach the desired menu or function.
- 2 Press **YES** to enter the menu or to select the function.
- 3 Press the navigation key to find the desired submenu or to select a setting alternative.

- 4 Press **YES** to enter the submenu or to confirm the setting.

**Note!** If you enter the menu system, but do not press any keys in 60 seconds, the phone will return to standby mode.

**Tip!** Instead of pressing the navigation key repeatedly, you can press and hold it down until you reach the desired menu or submenu.

## Display Text and Symbols



When you move through the menu system, the following hints can help you:

- Capital letters are used to indicate the menu or function selected.
- When **←** and **→** are displayed, there are more options you can scroll through with the navigation key.
- Text in brackets indicates the current setting of the function that is shown in the display.

Press  to enter the menu system. See inside the cover.

# The Phone Book

The Phone Book in your SH 888 lets you store and recall phone numbers. This means that the phone can store all your important numbers. You do not have to remember them or carry your address book around.

The Phone Book also keeps track of your last dialled numbers and, if you subscribe to the Calling Line Identification service, the last answered numbers. Convenient if you have to call someone back.

When you receive a call and the caller's number is in the Phone Book, you will see the name in the display.

**Tip!** Your SH 888 comes with the *Ericsson Mobile Office Suite* software. When installed on your computer, the Mobile Office Suite lets you manage your Phone Book from your computer in a simple way.

You can find more information about the Mobile Office Suite in the chapter 'The Mobile Office Suite'.

## Before You Start

Before you start creating your personal Phone Book, there are a few things you need to know. In this section, you will learn about the two different memories and how to store the numbers with the international prefix.

We also recommend that you at this stage read the section about entering characters, even though you might need to go back to this when you follow the instructions later on.

### Phone Book Memories

You can store your phone numbers in two different memories:

- the card memory on the SIM card,

- the phone memory.

Storing your numbers in the *card memory* allows you to use the numbers stored on the SIM card even when you change phones, i.e. when you insert your SIM card into another phone.

On the other hand, by storing your numbers in the *phone memory*, they are always available to you on your phone, even if you change SIM cards.

The memory positions in the card memory are numbered from 1 onwards. The actual number of memory positions available depends on your SIM card.

The phone memory can hold up to 99 phone numbers. The memory positions are labelled  $\times 1 - \times 99$ .

**Note!** In the 'Phone book' menu, press # to enter the  $\times$  character. Outside the 'Phone book' menu, you must press and hold down # to enter the  $\times$  character.

## International Numbers

If you intend to use your phone both at home and abroad, you should store all phone numbers as international phone numbers, that is with the '+' sign – which automatically will be replaced by the international dialling prefix for the country you are calling from – followed by the country code, then the area code and the phone number.

- To enter the (+) sign, press and hold 0.
- Omit any leading zero in the area code.

STORE	11
John, office	
+4646123456	

## Entering Characters

In the phone book you can accompany any number you store with a name. To enter the characters in the name, follow the instructions below.

- Press the appropriate key, 1–9, 0 or #, repeatedly until the desired character appears in the display.

Press...	to get...
1	Space - ? ! , . : " ' ( ) 1
2	A B C Ä Å Æ à ç 2 Γ
3	D E F è É 3 Δ Φ
4	G H I ì 4
5	J K L 5 Λ
6	M N O Ñ Ö Ø ò 6
7	P Q R S ß 7 Π Σ
8	T U V Ü ù 8
9	W X Y Z 9
0	0 + & @ / \$ % £ © ☺ Ψ Ω
#	# *

For example:

- To enter an A, press 2 once.
- To enter a B, press 2 twice.

**Tip!** To enter a digit, you can press and hold the numeric key.

To enter the second letter on the numeric keys directly, press and hold the upper volume key and press the desired numeric key. To enter the third letter, press the lower volume key instead.

**Note!** If there is a pause of more than 60 seconds between entering characters, the phone will return to the standby menu.

### To Enter Small Letters

- Enter the letter, for example an 'A', and then press \*. An 'a' appears.

Small letters now appear until you press \* again.

### To Check the First Characters

If you enter more characters than can be seen in the display, the first characters will be replaced by the \* symbol. To check the first characters you have entered:

- press the navigation key **LEFT**.

## Creating Your Personal Phone Book

### To Store a Phone Number

- 1 From the 'Phone book' menu, select 'Store'.
- 2 Enter a name to accompany the phone number. Use the numeric keys as described above.

3 Press the navigation key **RIGHT**.

4 Enter the phone number.

5 You now have four options:

- To save the number in the card memory, in the first empty position (displayed in the top right-hand corner):
  - Press **YES**.
- To save the number in the card memory, in a position you decide:
  - Press the navigation key **RIGHT**, enter the position and then press **YES**.
- To save the number in the phone memory, in the first empty position:
  - Press the navigation key **RIGHT**, press the # key twice and then press **YES**.
- To save the number in the phone memory, in a position you decide:
  - Press the navigation key **RIGHT**, press the # key once, enter the position and then press **YES**.

```
STORE      33
Name: John Doe
Enter no:  -
```

```
STORE      33
Name: John Doe
08111222
```

```
STORE      816
Name: John Doe
08111222
```

Press  to enter the menu system. See inside the cover.

**Tip!** If you enter a number in the scratch pad during a call, you can store it in the Phone Book by selecting 'Store' from the 'Phone book' menu while you have the number in the display.

```
STORE 2
Used
Overwrite?
```

### Overwrite Protection

If you try to store a phone number in a position which already contains a phone number, the message 'Used Overwrite?' appears in the display. You then have two options.

To store the number in a different position:

- 1 Press **NO**.
- 2 Enter the new position number.
- 3 Press **YES**.

To store the number in the selected position, thus erasing the old number:

- Press **YES**.

### When the Memories are Full

- If you try to store a phone number when all the positions in the *card memory* are full, a position number in the *phone memory* will be suggested on the top row of the display.
- If both memories are full, no position number will be suggested. If you still wish to store the phone number, you have to erase the old number by entering a position that is already occupied.

### To Store a Number With a Tone Signal Code

To use telephone banking services or control a phone answering machine, you will need to use codes. These codes are sent as tone signals (also called DTMF tones or touch tones).

If you want to save the phone number in the Phone Book with the codes:

```
STORE 34
e: Bankbyphone
040556677E_
```

- 1 Follow the instructions on how to store a phone number until you enter the number.
- 2 After entering the phone number, press and hold the \* key until the pause character 'P' appears.
- 3 Enter the code.
- 4 If needed, insert another pause, another code and so on.
- 5 Continue following the instructions on how to store a phone number.

To make a call with tone signal codes, proceed as described in 'Making and Receiving Calls'. When you make the call, the phone dials the number, waits until the call is answered and then sends the code. If you inserted another pause and another code, it will pause again, send the next code and so on.

## Recalling a Phone Number

### The Speed Dialling Facility

You can call the phone numbers that you store in the positions 1–9 in the *card memory* by entering the position number and then pressing **YES**. Therefore, you should save positions 1–9 for important numbers.

For example:

If you want to call John, whose number is stored in position 3 in the card memory:

- 1 Enter the digit 3.
- 2 Press **YES**.

### To Recall a Phone Number Using the Name

- 1 From the 'Phone book' menu, select 'Name recall'.

- 2 Enter the name you want to recall (or the first letters of it) using the numeric keys as described above.

You do not have to enter the entire name; the first few letters will do. The phone matches the letters with existing names in its memory.

- 3 Press **YES**.

The best match between the letters you entered and the names in the Phone Book is displayed. You can also see the storage position in brackets.

- 4 If the name displayed is not the one you want, press the navigation key until you find the correct name and number.
- 5 Press **YES** to make the call.

**Tip!** You can also enter the name directly after pressing **LEFT** from the empty standby display.

## To Recall a Phone Number Using the Position

If you know the memory position where you have stored a certain phone number, you can recall the number using the position.

- 1 From the 'Phone book' menu, select 'Position recall'.
- 2 Enter the position where the number is stored.
  - For a position in the card memory, simply enter the number.
  - For a position in the phone memory, press and hold the # key until the 'x' character appears and then enter the number.

- 3 Press **YES**.

The name and phone number now appear in the display.

- 4 If you entered the wrong position number, press the navigation key repeatedly until you find the phone number.

```
Emma LimeTREE  
4 (7) >  
+464612345
```

```
POSITION  
RECALL  
Position: 7
```

```
Emma LimeTREE  
4 (7) >  
+464612345
```

- 5 To call the number, press **YES**.

**Tip!** You can also enter the position directly in the standby display and then press the # key to recall the phone number. Do not forget the 'x' before the position if the number is stored in the phone memory (to get the 'x' character, press and hold the # key).

## Hiding or Showing Your Number When Making a Call

With most common subscriptions, the caller's number is sent when a call is made. This means that the receiver can see your phone number when you make a call. However, some operators offer subscriptions where your phone number is normally hidden.

If you want to change the setting for a particular call, this is possible provided the network you use supports it.

To hide your phone number for a particular call, when you recall a number from the Phone book:

- 1 Recall the phone number, but press **NO** instead of **YES**.

The number is now shown in the standby display.

- 2 Press the navigation key **RIGHT**.

The 'Special functions' menu now appears.

- 3 Press **YES** to enter the 'Special functions' menu.
- 4 Press the navigation key repeatedly until 'Hide Id' appears.
- 5 Press **YES** to make the call.

To show your number for a particular call, when you recall a number from the Phone book:

- 1 Recall the phone number, but press **NO** instead of **YES**.

The number is now shown in the standby display.

- 2 Press the navigation key **RIGHT**.

The 'Special functions' menu now appears.

- 3 Press **YES** to enter the 'Special functions' menu.
- 4 Press the navigation key until 'Send Id' appears.
- 5 Press **YES** to make the call.

## Keeping Your Phone Book Up to Date

As the people you know change jobs, move, marry etc., you might want to change the names and numbers in your Phone Book, or perhaps delete some of the entries.

### To Edit an Entry in the Phone Book

There are two ways of finding the Phone Book entry you wish to edit. You can use either the storage position or the name.

To edit the entry using the position:

- 1 From the 'Phone book' menu, select 'Edit'.
- 2 Enter the position number for the entry you wish to edit.
  - For a position in the card memory, simply enter the number.
  - For a position in the phone memory, press and hold the # key until the 'B' character appears and then enter the number.
- 3 To select the entry, press **YES**.

You will now see:

- the name (displayed on the middle row),
- the phone number (displayed on the bottom row),
- the storage position (displayed on the top row).

- 4 To select the row you wish to edit, press the navigation key **RIGHT**.

You will see the cursor on the right of the row you selected.

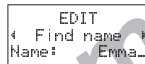

```
EDIT
Find name
Name: EMMA
```

- 5 Edit the row by using:
  - the **CLR** key to erase,
  - the numeric keys to enter letters or digits,
  - the navigation key to move the cursor left (or right when it is positioned in a row).
- 6 If needed, press the navigation key **RIGHT** to select another row and continue editing.
- 7 To save the changes, press **YES**.

To edit the entry using the name:

- 1 From the 'Phone book' menu, select 'Edit'.
- 2 Press the navigation key **LEFT**.

The display now shows 'Find name' in the middle row.

- 3 Enter the name for the entry you wish to edit, using the numeric keys. The more letters you enter, the better the match.
- To select the entry, press **YES**.
- 4 You can now continue from number 4 above.

### Erasing a Phone Number

To erase a phone number from the Phone Book:

- 1 Recall the number using 'Name recall' or 'Position recall'.
- 2 Press and hold **CLR**. The question 'Erase?' appears.
- 3 To erase the number, press **YES**.

**Note!** You can also select 'Erase' from the 'Phone book' menu and then enter the storage position.

If you want to erase all numbers from the phone memory (not possible for the card memory), you can do this as follows:

- 1 From the 'Phone book' menu, select 'Erase all from phone'.
- 2 To erase all phone numbers from the phone memory, press **YES**.

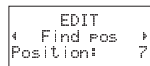

```
EDIT
Find Pos
Position: 7
```

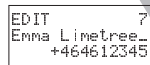

```
EDIT
Enna Limetree
+464612345
```

## Copying Phone Numbers between Positions and Memories

As you fill up the Phone Book memories, you might want to move entries from one memory to another or between positions in the memories.

### To Copy All Numbers from Card Memory to Phone Memory

COPY ALL  
← Card→Phone →

COPY CARD  
From start  
position: --

- 1 From the 'Phone book' menu, select 'Copy all'.
- 2 Scroll to 'Card→Phone' and press **YES**.
- 3 Enter the number of the first position in the *card memory* you wish to copy and press **YES**.
- 4 Enter the number of the first position in the *phone memory* you wish to copy to and press **YES**.
- 5 To start the copying, press **YES**.

### To Copy All Numbers from Phone Memory to Card Memory

COPY ALL  
← Phone→Card →

COPY PHONE  
From start  
position: CL

- 1 From the 'Phone book' menu, select 'Copy all'.
- 2 Scroll to 'Phone→Card' and press **YES**.
- 3 Enter the number of the first position in the *phone memory* you wish to copy and press **YES**.
- 4 Enter the number of the first position in the *card memory* you wish to copy to and press **YES**.
- 5 To start the copying, press **YES**.

### To Copy Numbers from Card Memory to Phone Memory One by One

COPY  
← Card→Phone →

- 1 From the 'Phone book' menu, select 'Copy'.
- 2 Scroll to 'Card→Phone' and press **YES**.
- 3 Enter the number of the first position in the *card memory* you wish to copy and press **YES**.

Eric Woods  
12  
Copy to R??

- 4 Enter the number of the first position in the *phone memory* you wish to copy to and press **YES**.
- 5 To start copying, press **YES**.  
The starting position in the *card memory* is displayed and the next empty position in the *phone memory* is suggested.
- 6 For every entry on the card, from the start position onwards, press:
  - **YES** to copy.
  - **NO** to go to the next position in the *card memory*.
  - **CLR** to copy to another position in either the *card* or *phone memory*. Enter the number of the position and press **YES**.
  - Navigation key **LEFT** or **RIGHT** to move between positions in the *card memory*.

To interrupt copying:

- Press **CLR** twice.

### To Copy Numbers from Phone Memory to Card Memory One by One

- 1 From the 'Phone book' menu, select 'Copy'.
- 2 Scroll to 'Phone→Card' and press **YES**.

To copy from the phone memory to the card memory use the **YES**, **NO** and **CLR** keys as described above.



# Sending and Receiving Text Messages

A very convenient feature of your Ericsson SH 888 is the Short Message Service (SMS). This allows you to send and receive text messages consisting of up to 160 characters.

Using the Short Message Service, you do not have to worry about whether the people you want to reach check their answering machines or not. As soon as they turn on their phone, the message will be waiting for them.

Text messages can be received when the phone is in standby mode, during a call or when incoming calls are diverted to another phone number. If the recipient's phone is turned off when a message is sent, a notifying message will be displayed soon after the phone is turned on.

Apart from sending standard messages to phones, your Ericsson SH 888 is also prepared for sending fax messages (group 3 and 4), X400 messages, e-mails and telexes, via the Short Message Service. Check with your network operator which message types you can use and how.

**Tip!** Your SH 888 comes with the *Mobile Office Suite* software. The Mobile Office Suite makes it possible for you to write and read SMS messages on your computer. For more information on how this is done, please see the chapter 'The Mobile Office Suite'.

**Note!** The Short Message Service may not be available in all networks.

## Two Memories

### The Messages Memory

If you do not want to read an incoming message at once, it is automatically stored in the Messages memory in the phone. This allows you to read it later on.

If there are any unread incoming messages in the messages memory, a letter icon (✉) will appear to the left at the bottom of the display.

The Messages memory can hold up to 10 messages. When all memory positions are full, the oldest read message will be overwritten when a new message is received.

If the Messages memory becomes full with unread messages, new messages will automatically be stored in the SIM card memory. If the SIM card memory becomes full, the letter icon (✉) starts blinking.

Messages remain in the Messages memory until you erase them (see 'Erasing a Message,') until you insert a different SIM card, or until the telephone needs the memory space to store new messages

### The SIM Card Memory

If you receive an important message and want to make sure it is not erased from the messages memory, you can store it in a memory on your SIM card. This means that you can retrieve the message regardless of which phone you use. Messages that are saved in the SIM card memory remain there until you erase them.

If the SIM card memory becomes full, the letter icon (✉) starts blinking.

## Setting the Phone for Text Messaging

If the phone number to your network service centre cannot be retrieved from your SIM card, you must specify the number yourself. Otherwise you cannot reply to received messages or send your own messages.



- ❶ From the 'Mail' menu, select 'Send message'.
- ❷ Scroll to 'Options' and press **YES**.
- ❸ Scroll to 'Serv cent' and press **YES**.
- ❹ If there is no number in the display, enter the number of the service centre, including the international prefix, and press **YES**.
- ❺ To return to standby mode, press **CLR**.

Your phone is now ready to send and receive text messages.

**Note!** Some network operators may only allow SMS to be sent within their own network.

### Setting Duration of Message

If your message cannot be delivered because the recipient is not within reach of a network, you can instruct your Service Centre to repeat the message for one hour, 12 hours, one day, one week or the maximum period (determined by your service provider).

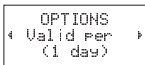

- ❶ From the 'Mail' menu, select 'Send message'. 'New' appears.
- ❷ Scroll to 'Options', using the navigation key, and press **YES**.
- ❸ Select the 'Valid per' option and press **YES**.
- ❹ Scroll to the desired duration and press **YES**.

### Changing Message Types

The phone is prepared for sending other types of messages. Your network operator's Service Centre may offer the facility to convert a text message into a format

(fax, telex, voice, etc.) that suits the equipment that is going to receive the message.

Consult your operator for further information about the formats you can use.

To set the message type:

- ❶ From the 'Mail' menu, select 'Send message'.
- ❷ Scroll to 'Options', using the navigation key, and press **YES**.
- ❸ Scroll to the 'Msg type' option and press **YES**.
- ❹ Select the required format, using the navigation key, and press **YES**.



**Note!** Standard means an ordinary text message (SMS) to other phones. Standard is the default message type.

## Composing and Sending Messages

### To Enter Letters

In order to compose your message, you have to know how to enter characters using the numeric keys.

- Press the appropriate key, 1–9, 0 or #, repeatedly until the desired character appears in the display.

Press...	to get...
1	Space - ? ! , . : " ' ( ) 1
2	A B C Ä Å Æ à Ç 2 Γ
3	D E F è É 3 Δ Φ
4	G H I ì 4
5	J K L 5 Λ
6	M N O Ñ Ò Ø ò 6
7	P Q R S ß 7 Π Σ
8	T U V Ü ù 8
9	W X Y Z 9
0	0 + & @ / \$ % £ © ≡ Ψ Ω
#	# *

Press  to enter the menu system. See inside the cover.

For example:

- To enter an A, press 2 once.
- To enter a B, press 2 twice.

**Tip!** To enter a digit, you can press and hold down the numeric key.

To enter the second letter on the numeric keys directly, press and hold the upper volume key and press the desired numeric key. To enter the third letter, press the lower volume key instead.

To enter small letters:

- Enter the letter, for example an 'A', and then press \*. An 'a' appears.  
Small letters will now appear until you press \* again.

If you enter more characters than can be seen in the display, the first characters will be replaced by the ← symbol. To check the first characters you have entered:

- Press the navigation key **LEFT** until you reach the characters you want to view.

**Note!** If there is a pause of more than 120 seconds between entering characters, the phone will return to the standby menu.

## Sending Messages

- 1 From the 'Mail' menu, select 'Send message'. 'New' appears.
- 2 Press **YES**. An empty display appears.
- 3 Enter your message. (See 'To Enter Letters').

You can scroll through the message text with the navigation key and erase characters to the left of the cursor or insert characters in the cursor's position.

- 4 When you have completed your message, press **YES**. 'Request reply?' appears.
- 5 If you want the recipient to reply to the message, press **YES**. If not, press **NO**.

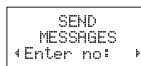

SEND  
MESSAGES  
← Enter no: →

- 6 Enter the recipient's phone number or recall it from the phone book. To access the 'Phone book' menu press **LEFT**.
- 7 You now have two options:
  - To send the message now, press **YES**.
  - To store the message for later use, press **NO**. The message is now stored in the messages memory.

If you decide to send the message later, the message is labelled 'To Send' instead of 'Sent' when you access the message in the 'Read messages' menu.

**Note!** The same procedure is used with all types of messages, for example e-mail, fax etc. Check with your network operator which message types you can use.

## Reading a Message

When you receive a message, you hear a sound and the display informs you of it. The indicator light on the top of the phone rapidly blinks green.

You now have two options:

- If you want to read the message at once, press **YES**.
- If you want to read the message later on, press **NO**. The message will be stored in the Messages memory and a letter icon (E2) will appear on the left at the bottom of the standby display.

If you pressed **YES**, you will see the first three lines of the message, showing you who the message is from and when it was received. 'New' stands for a new unread message.

If the message is older than 24 hours, the time will be replaced with the date the message arrived. However, you can toggle between the date and time by pressing the \* key.

- To read the first line of the message, press **YES**.

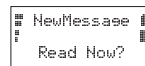

NewMessage  
Read Now?

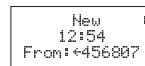

New  
12:54  
From: +456887



MAIL  
Send  
Message

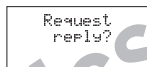

Request  
reply?

- Scroll through the message using the navigation key. **RIGHT** takes you forwards and **LEFT** takes you backwards through the message.
- To move three lines forwards, press 3. To move three lines backwards, press 1.
- To return to the beginning of the message, press and hold **LEFT**.

Goodbye!  
 < Reply?

The message 'Reply?' appears after the last line of the message. If the caller wants you to reply, the displayed message will say 'Reply Requested Reply?', provided your network supports this.

## Replying to a Message

When you are reading a message, at the end you are asked if you want to reply to the message. If you want to do this:

- Press **YES**.

Your display now looks like the picture in the margin.

< New >

- To enter your message, press **YES** and proceed as described in 'Composing and Sending Messages'.

If you do not want to reply:

- Press **NO**.

## Erasing a Message

When you are reading a message, at the end you are asked if you want to reply to the message.

- 1 Press **NO**.

The message 'Erase?' appears.

- 2 To erase the message from the Messages memory, press **YES**.

The next message automatically appears in the message list.

Goodbye!  
 < Erase?

**Note!** You can press **CLR** anywhere within the menu that handles your message to erase it. When 'Erase?' appears, press **YES**.

## Storing a Received Message

All incoming messages are stored temporarily in the messages memory until the memory space is needed for other purposes, such as storing new messages. Even so, sometimes you may receive an important message that you want to store more safely. This is better done in the SIM card memory.

When reading the message and the question 'Erase?' appears:

- 1 Press **NO**.

The message 'Store?' appears.

- 2 To store the message in the SIM card memory, press **YES**. The message is automatically moved from the Messages memory to the SIM card memory.

Goodbye!  
 < Store?

Stored  
 On card  
 3(5)

The display now shows the position of the message. For example, if it is the third of five that the phone can store.

**Note!** If the card memory is full, the text 'Not stored Mem full' appears. In this case you will have to erase one or more messages, before you can store any new messages in the SIM card memory.

**Tip!** You can also store messages you have composed yourself on the SIM card. See the section 'Sending Messages' above.

Press  to enter the menu system. See inside the cover.

## Reading Stored Messages

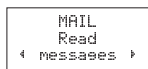

- 1 From the 'Mail' menu, select 'Read messages'.
- 2 Scroll with the navigation key until you find the message you are looking for.
  - 'New' stands for a new unread message.
  - 'Old' stands for a read message.
  - 'Sent' stands for a sent message.
  - 'To Send' stands for a composed, but not sent message.
- 3 Press **YES**.
- 4 Read the message as described in 'Reading a Message'.

**Note!** If there is a \* in front of the message, this means that it is stored on the SIM card.

## Calling a Phone Number in a Message

To call a phone number found in a message:

- Press **YES**.

After the number has been called, the message is considered read and it remains in the Messages memory.

## Frequently Used Messages

If you have one or more standard messages you use often, you can store them on the SIM card, to be reused whenever you want.

### Storing Frequently Used Messages

To make sure your standard messages are not erased when the messages memory becomes full, you should store them in the SIM card memory. To do this:

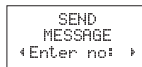

- 1 From the 'Mail' menu, select 'Read messages'. The messages saved in your Messages memory appear.
- 2 Scroll to the message you wish to store in the SIM card memory, using the navigation key, and press **YES**.
- 3 Press **YES** again. 'Erase?' appears.
- 4 Press **NO**. 'Store?' appears.
- 5 Press **YES**. The message is now moved from the phone memory to the SIM card memory.

### Sending Stored Messages

- 1 From the 'Mail' menu, select 'Send message'. 'New' appears.
- 2 Scroll to the message you wish to send, using the navigation key, and press **YES**. Now you can edit your message, if you wish.
- 3 When the message is ready to be sent, press **YES**. 'Request reply?' appears.
- 4 If you want the recipient to reply to the message, press **YES**. If not, press **NO**.
- 5 Enter the recipient's phone number or recall it from the phone book. To access the 'Phone book' menu, press **LEFT**.
- 6 To send the message now, press **YES**.

# Communicating via the Modem

A very convenient feature of the SH 888 is the in-built modem (which equals a PC Card modem). With this, you can connect a computer to your phone in order to send and receive fax and e-mail messages, browse the Internet and much, much more.

With the SH 888 you can choose if you want to connect to your computer via infrared link (IR) or via cable.

Note that to be able to use various communication services you also need appropriate software, for example a fax application, an e-mail application or an Internet browser.

Your SH 888 comes with either a CD or a set of diskettes (or both, depending on what country you bought your phone in), containing a modem script and the *Ericsson Mobile Office Suite* software, among other things.

The Mobile Office Suite is a phone book manager and a message manager. See the chapter 'The Mobile Office Suite' for more information.

You will also find the Microsoft IrDA driver, the Microsoft Windows CE driver and modem script.

## Before you Start

Before you can start using communication applications there are a few things that need to be taken care of:

- Firstly, you need to make sure your computer is configured for infrared communication. Most computers are already configured, but if this is not the case, please see your computer's user manual for more detailed information.

- Secondly, you need to install the Microsoft IrDA driver and the Ericsson SH 888 modem script on your computer. These are found on the CD and/or the diskettes that came with your phone. Detailed instructions are found in the section 'Installing the Infrared Modem' below.
- For you to be able to use the above mentioned services most phone network operators require that you have separate fax and data subscriptions. This way you never need to worry about whether an incoming call is a fax, data or normal speech call. If you do not already have separate fax and data subscriptions, please contact your operator.

**Note!** Do not expose your in-built modem to electrostatic discharge (ESD). The communication link may be lost and could lead to unintentional loss of data. Should you lose connection, you may need to restart your computer and/or your mobile phone.

## The Data Menus

Some of the communication features described in this chapter require that you have the 'Data menus' in your phone turned on. To turn them on:

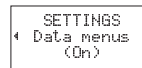

- ❶ In the 'Settings' menu, scroll to 'Data menus'. The current status (on or off) is now shown on the bottom row of the display.
- ❷ Press **YES** to change the status if needed (that is from off to on or vice versa). Then press **YES** again to confirm the setting.

Press  to enter the menu system. See inside the cover.

## Installing the Infrared Modem

### Before you start

Make sure that the phone's IR port is activated.

To activate the IR port:

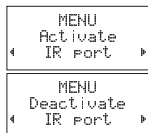

- 1 In the menu system, scroll to 'Activate IR port' and press **YES**. (If the IR port is already activated, the display will read 'Deactivate IR port' instead. In this case, just press **CLR** to return to the standby menu.)

For a few seconds the text 'IR port activated' appears in the display. The phone then returns to standby mode.

- 2 Place your phone less than one metre from your computer (or your H/PC) and make sure that the infrared ports are aligned (within 30°).

The examples in this manual may differ from your PC. If you require more information during the installation process than provided by this User's Guide, we suggest that you consult your PC supplier or your computer's manuals.

### Installation Flowchart for Windows 95

We recommend that you use step 1 - 4 in the flowchart below as a checklist in order to assure that your computer has been configured properly for a successful installation of the infrared modem.

The boxes in the flowchart apply to the sections with corresponding titles in this User's Guide.

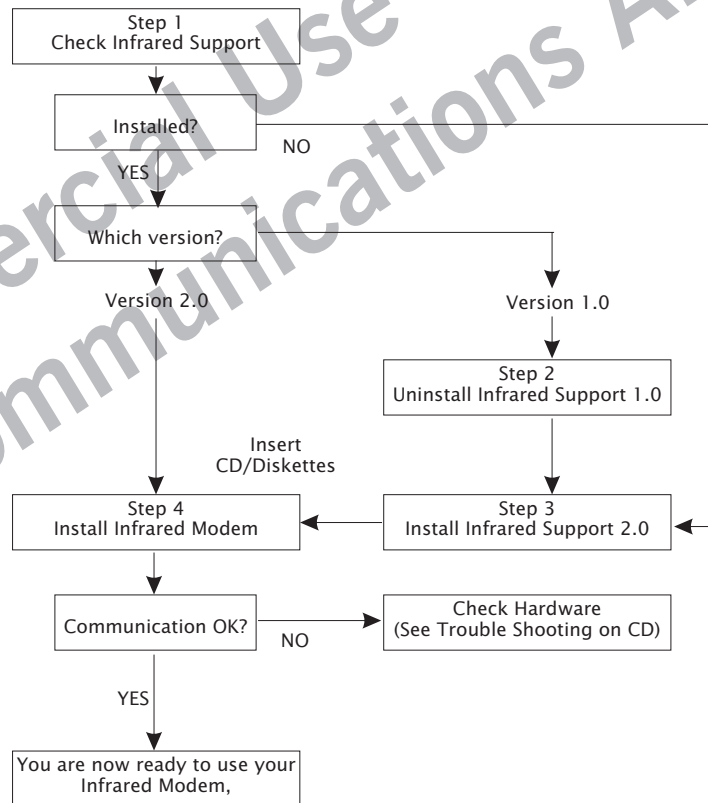

## Step 1 – Check Infrared Support

Before installing the infrared modem you also need to check if the Microsoft Infrared support for Windows version 2.0 has been installed.

To do this, and also to check the version of the existing infrared support on your computer, do the following:

- 1 Under Settings in the Start menu, select Control Panel.
- 2 Select the Add/Remove Programs applet.
- 3 Check the version of the Infrared Support for Windows 95 in the list under the Install/Uninstall tab.
  - Version 2.0

If you have version 2.0 installed you do not need to install the infrared support. Go to section 'Step 4 – Install Infrared Modem' to continue the installation of the infrared modem.

- Version 1.0

If you have version 1.0, you need to uninstall this version before installing infrared support version 2.0. Go to 'Uninstall Infrared Support' to continue the installation of the infrared modem.

- No Infrared Support Installed

Go to 'Step 3 – Install Infrared Support' to continue the installation of the infrared modem.

## Step 2 – Uninstall Infrared Support

- 1 Under Settings in the Start menu, select Control Panel.
- 2 Select the Add/Remove Programs applet.

- 3 Select the Microsoft Infrared Support for Windows version 1.0.
- 4 Click the Add/Remove button.
- 5 Click OK.

Go to 'Step 3 – Install Infrared Support' to continue the installation of the infrared modem.

## Step 3 – Install Infrared Support

- 1 Insert the CD into your computer's CD drive or the diskette containing the Infrared support into the diskette drive.
- 2 If you are using a diskette or if your CD does not start automatically, select 'Run' in the 'Start' menu. Type A:\setup if you are using diskettes or D:\setup if you are using a CD (could be another drive). Click OK.
- 3 When the Setup dialogue appears on the screen, click the Install Infrared Support for Windows 95 version 2.0 button.
- 4 Follow the instructions given on the screen
- 5 When the Add Infrared Device Wizard appears, select the Built-in infrared port on laptop or desktop and click Next.
- 6 When the next page of the Wizard appears on the screen, select the COM port enabled for infrared communication and click Next.
- 7 When the third and last page appears on the screen, accept the default settings by clicking OK.

After the installation you will return to the Setup dialogue where you can continue the installations.



## Step 4 – Install Infrared Modem

- 1 Insert the CD into your computer's CD drive or insert the diskette into the diskette drive.
- 2 Place the phone with the infrared modem next to your PC. See illustration below. (The infrared port may be positioned differently on your computer.)

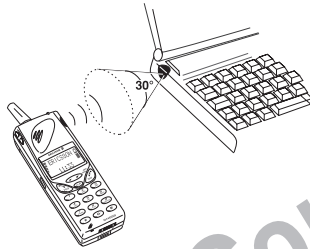

- 3 Close the Control Panel if it is open.
- 4 Open the Control Panel.
- 5 Double click the Infrared Monitor icon.
- 6 Select the Options tab and make sure that the check box 'Enable infrared communication on:' is checked. In most cases the infrared communication is enabled on COM2 or COM3.

**Tip!** To check that the infrared communication is enabled, click the Status tab. The message 'One infrared device is in range' should be displayed. Your computer will now discover the new hardware and a dialogue box will appear.

- 7 Click Next.
- 8 When the next dialogue box appears select the drive and folder containing the modem script.  
A: if you are using diskettes or D: (could be another drive) if you are using the CD. Click OK.

**Tip!** To check that the infrared modem has been installed successfully, go to Control Panel and select Modems. Ericsson SH 888 should appear in the list under the General tab.

## Installation – Windows CE

- 1 Make sure that you have Microsoft H/PC Explorer or Windows CE Services installed on your laptop. Also make sure that communication between your H/PC and your PC is established.
- 2 Insert the CD into your PC's CD drive or insert the diskette containing the Infrared support into the diskette drive.
- 3 Installing from CD:

When the setup dialogue box appears on the screen, click the 'Install Infrared Modem for Windows CE' button.

Installing from diskette:

Select 'Run' in the 'Start' menu. Click 'Browse' and locate the Windows CE folder on your diskette drive. In the Windows CE folder, double-click 'Install'.

The infrared modem will be installed automatically on your H/PC.

- 4 Reset your H/PC. (Usually this is done by pressing a reset button placed in the backup battery compartment.)

If you installed from the CD, you will return to the setup dialogue after the installation, where you can continue by installing the Mobile Office Suite application, for example.

## To Connect Using the IR Link

The IR feature of the SH 888 allows you to connect to a computer without using a cable. This option requires that your computer has an IR port, and that the operating system supports the IrDA standard for infrared communication (see above). To enable IR communication:

- 1 On your computer, start the infrared application by double-clicking the icon in the 'Control Panel'.
- 2 Place the phone less than one metre from the computer and make sure the IR ports are aligned (within 30°). Your PC will now establish contact with your phone. This is indicated by the infrared icon in the status bar.
- 3 Now you are ready to start infrared communication between your computer and your phone.

**Note!** Before disestablishing contact between your PC and your SH 888, make sure that you close any communication application on your PC.

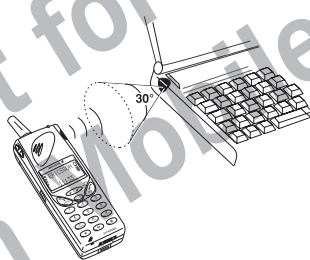

## To Connect Using the RS232 Cable

Using the RS232 cable provided is the most power efficient way to use your SH 888 together with a

computer. To enable use of the IrDA protocol, using the RS232 cable:

- 1 Connect the cable according to the picture below.
- 2 Under the tab 'Options' in the Infrared Monitor found in the Control Panel folder, select infrared communication on the COM port you intend to use.

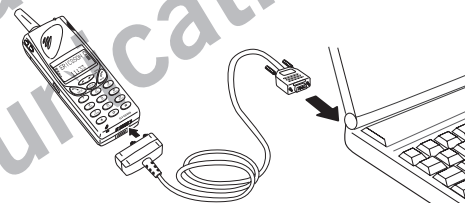

## Making Fax and Data Calls

### Software-Initiated Fax and Data Calls

Fax and data calls are normally initiated from within the computer software. Do the following:

- 1 Connect your computer to the phone, using the IR port or the RS232 cable.
- 2 Start the appropriate software application on your computer and follow the procedure that is appropriate for the software.

**Note!** Make sure that you have selected the SH 888 modem.

When a fax or data call is in progress, the phone display shows the call type, that is 'Fax' or 'Data'.

Press  to enter the menu system. See inside the cover.

## Speech then Fax Calls

In some cases, you might want to speak to the receiving part before starting the fax transmission. This call type is referred to as a *speech then fax call*.

**Note!** This feature must be supported by your network operator and you may need a separate subscription.

To set up a speech then fax call:

- 1 Connect your computer to the phone, using the IR port or the RS232 cable.
- 2 Scroll to 'Speech then FAX' in the menu system (the 'Data menus' must be turned on) and press **YES**. The display will look like the picture in the margin.
- 3 Enter the receiving part's number and press **YES**. When the call is set up, the display looks like the picture in the margin. The call is now in speech mode.
- 4 Use the manual send mode (or similar function) in your fax software to send the fax.

SPEECH  
THEN FAX  
Enter no#

Speech/Fax  
Fax on?

Answer?  
Fax  
0123456

## Receiving Fax and Data Calls

The procedure for receiving fax and data calls depends on your network and subscription. If you have different numbers for speech, fax and data calls, this is referred to as *multi numbering*. This means that you can have up to three numbers in your subscription. If you only have one number for all call types, this is referred to as *single numbering*.

### Receiving Fax and Data Calls – Multi Numbering

If your network and subscription support multi numbering, the SH 888 will display the type of incoming call. There are four possible types apart from speech calls:

- Fax calls

- Data calls
- Speech then fax calls
- Fax then speech calls

The display shows the type of call on the middle row.

To receive a fax or data call:

- 1 Connect your computer to the phone.
- 2 Answer the call from within the software application (if it does not answer automatically).

To receive a speech then fax call:

- 1 Answer the call.
- 2 Connect your computer to the phone.
- 3 Receive the fax from within the software application.

To receive a fax then speech call:

- 1 Connect your computer to the phone.
- 2 Answer the call from within the software application (if it does not answer automatically).
- 3 After receiving the fax, pick up the phone and continue the speech call.

### Receiving Fax and Data Calls – Single Numbering

If your network and subscription only support single numbering, the phone does not recognize the type of incoming call. This means that the calling part has to tell you if you are going to receive a fax or data call.

Do the following to prepare your phone for a certain type of call:

- 1 In the menu system, scroll to 'Next call type' (the 'Data menus' must be turned on) and press **YES**.
- 2 Select the type of call you are going to receive.
  - If you select 'Speech', the next call will be handled as a speech call.

- If you select 'Speech/FAX', the next call will be handled as a speech then fax call.
  - If you select 'FAX/Speech', the next call will be handled as a fax then speech call.
  - If you select 'FAX', the next call will be handled as a fax call.
  - If you select 'Data', the next call will be handled as a data call.
- ③ Receive the call according to the instructions above.

**Note!** The next call setting remains until you change it. The current setting, if not a speech call, is shown on the middle row of the standby display (see picture in the margin).

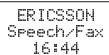

ERICSSON  
Speech/Fax  
16:44

# The Mobile Office Suite

The *Mobile Office Suite* is a Phone Book Manager and a Message Manager. Once installed on your computer, the application allows you to organize the names and telephone numbers that you store in your phone book. It also allows you to write and read SMS messages on your computer.

## The Phone Book Manager

The Phone Book Manager allows you to dial other parties, manage telephone numbers and names as well as check the status of the phone. It consists of an Address Book, a Dialler and a Phone Status Display.

For instructions on how to use the Phone Book Manager, please consult the on-line help texts associated with the application.

## The Message Manager

The Message Manager makes it possible to create, send, receive and organize SMS messages.

For instructions on how to use the Message Manager, please consult the on-line help texts associated with the application.

## Installing the Mobile Office Suite

Before you start the installation, make sure you have installed the modem script according to the instructions given the chapter 'Communicating via the Modem'.

- 1 Close all applications on your computer.
- 2 Connect your mobile phone to the computer using the IR port or the RS232 cable (do not forget to start the 'Infrared' application in the 'Control Panel').

Press  to enter the menu system. See inside the cover.

## Installation from a Diskette

- 1 Under 'Settings' in the 'Start' menu, select 'Control Panel'.
- 2 Select 'Add/Remove' programs, and click the 'Install' button.
- 3 Insert the first installation disk.
- 4 Follow the instructions given on the screen.

If a modem other than the SH 888 modem has been selected, the Mobile Office Suite may be unable to detect your phone. If this is the case, you will need to change to the SH 888 modem.

To do this:

- 1 Click 'Cancel'.
- 2 Select the SH 888 modem from the drop-down list.

You will need to restart your computer before you can start using the Mobile Office Suite. To access the Mobile Office Suite, double-click its icon on the desktop.

## Installation from a CD

An installation program will start automatically when you insert the CD into your drive.

- 1 Click 'Install Mobile Office Suite'.
- 2 Follow the instructions given on the screen.
- 3 Select the Ericsson SH 888 modem from the 'Modem' drop-down list if it is not already selected.

You will need to restart your computer before you can start using the Mobile Office Suite. To access the Mobile Office Suite, double-click its icon on the desktop.

## **Uninstalling the Mobile Office Suite**

- ❶ Under 'Settings' in the 'Start' menu, select 'Control Panel'.
- ❷ Click 'Add/Remove Programs'.
- ❸ Select 'Ericsson Mobile Office Suite' from the list of applications.
- ❹ Click 'Add/Remove'.
- ❺ Follow the instructions given on the screen.

# Networks

When you turn on the phone, it normally selects its home network. If this is not within range, for example when you are abroad, you may use another network, provided your home network has an agreement that allows you to do so. This is called *roaming*.

The 'Networks' menu includes a number of functions which you can use to determine how the phone searches for a network. You may also select a network yourself from those within range.

## Search Mode

### Automatic Search Mode

The automatic search mode means that when you turn on your phone, it searches for its home network first. If this is not available, the phone will automatically search for another available network within range.

The Automatic search mode is normally the default setting when you buy your phone. However, if you need to activate the automatic search mode, do the following:

- 1 Scroll to the 'Networks' menu, using the navigation key, and press **YES**.
- 2 Scroll to 'Searchmode'.
  - If '(Auto)' is visible on the bottom row of the display, your phone is already set to Automatic search mode.
  - If '(Auto)' is not visible, press **YES**.
- 3 Scroll to 'Auto' and press **YES**. The phone is now set to Automatic search mode.
- 4 To return to standby mode, press **CLR**.

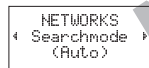

**Note!** The order of preference in which the phone selects a network is determined by a list of preferred networks on your SIM card, which you can edit at any time.

### Manual Search Mode

The manual search mode means that when you turn on your phone, it searches for its home network first and then for the network that it used last. If none of these networks are within range, the question 'Select network?' appears.

To activate the manual search mode, do the following:

- 1 From the 'Networks' menu, select 'Searchmode' and press **YES**.
- 2 Scroll to 'Manual' and press **YES**.
- 3 To return to standby mode, press **CLR**.

To select a network, see below.

## Selecting a Network

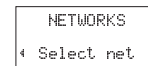

- 1 From the 'Networks' menu, choose 'Select net'. The message 'Please wait' is displayed briefly. If there is more than one network within range, you can use the navigation key to scroll to the other network(s).
- 2 When the network you wish to use is displayed, press **YES** to select it.

**Note!** Together with the network name, you also get the following information in the display:

- If the home network is within range and you are using it when you start your network selection,

the name of the network is displayed with the message 'Current'.

- If you are using another network and your home network is available, the name of the home network is displayed with the message 'Home'.
- Instead of the full name of a country and a network, an abbreviation is displayed when you use the 'Networks' menu. To see the full name of a network, press \*.
- If the home network is not within range, the name of another network is displayed with the message 'Current', 'Preferred', 'Available' or 'Forbidden'.
  - 'Current' means that the network is currently being used.
  - 'Preferred' means that the name of the network is included in a list of preferred networks on your SIM card.
  - 'Forbidden' means that the name of the network is included in a list of forbidden networks on your SIM card and that you are not allowed to use it. You can, however, make emergency calls.
  - 'Available' means that there is a network within range, which is not on either the forbidden or preferred list on your SIM card.
- If there is no network within range, the message 'No network' is displayed.

### To Start an Automatic Network Search

An automatic network search can be started at any time.

- From the 'Networks' menu, select 'New search'.

The phone automatically starts searching for a network according to the list of preferred networks stored on your SIM card.

### Forbidden Networks

The names of the forbidden networks are stored on your SIM card. If such a forbidden network is within

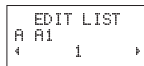
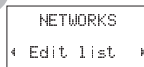
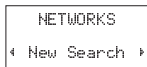

range, it will be omitted when the phone searches for a network (automatic search mode).

If your home network and a forbidden network come to an agreement that allows you to use the forbidden network, you can select this network even though the message 'Forbidden' is displayed.

## List of Preferred Networks

You can create a list that defines in which order your phone will select a network during automatic network selection, when your home network is not within range.

The number of networks that can be stored in the list depends on your SIM card.

The 'Edit list' function lets you review the networks in the list. Apart from rearranging the order of the networks, you can add new networks to the list and delete networks from it.

### Reviewing the List of Networks

- 1 From the 'Networks' menu, select 'Edit list'.
  - The message 'Please wait' is displayed briefly.
  - The name of the first network is displayed. If a network is within range, a \* is also displayed.
- 2 You can scroll through the other networks in the list by using the navigation key.

**Note!** To see a network's full name, press \*.

### Adding a Network to the List:

- 1 From the 'Networks' menu, select 'Edit list'.
- 2 Scroll to the first free position in the list and press **YES**. The question 'Add net?' appears. If you scroll to a position that is already occupied, you must press **YES** and then scroll with the navigation key until 'Add net?' appears.

Press  to enter the menu system. See inside the cover.



- ③ Press **YES** and scroll with the navigation key until you find the desired network.  
If the desired network does not appear, press **YES** when the question 'Other?' appears. Then enter the three-digit country number and the two-digit network number.
- ④ Finally, to add the network to the list, press **YES**.

### Erasing a Network from the List

- ① From the 'Networks' menu, select 'Edit list'.
- ② Scroll to the network you wish to erase and press **YES**.
- ③ Scroll until 'Erase' appears.
- ④ To delete the network from the list, press **YES**.

```
EDIT LIST
A A1
← Erase? →
```

### Rearranging the List

- ① From the 'Networks' menu, select 'Edit list'.
- ② Scroll to the network you wish to move and press **YES**.
- ③ 'Move' is displayed. Press **YES** and enter the new position within the list.

```
EDIT LIST
A A1
← Move? →
```

## The Card Lock

Your SIM card is protected by a card lock. When you buy your SIM card, you obtain a PIN (Personal Identity Number).

Every time you turn the phone on, you have to enter your PIN and then press **YES**, unless you turn this feature off (see below).

If you enter your PIN incorrectly three times in a row, the SIM card will be blocked. This is indicated by the message 'Card blocked Unblock?'. If this happens, see 'If Your SIM Card Is Blocked' below.

**Note!** If your PIN starts with the same digits as the international emergency number 112, they will appear in the display, when you enter your PIN.

### To Change Your PIN

- 1 From the 'Access' menu, select 'Change PIN code'.
- 2 Enter your old (current) PIN and press **YES**.
- 3 Enter your new PIN and press **YES**.
- 4 At the prompt 'Repeat new PIN', enter your new PIN a second time and press **YES**.

The message 'New PIN' confirms that the PIN has been changed.

**Note!** If the message 'Matching error' appears, this means you entered the new PIN incorrectly. If the message 'Wrong PIN' appears, followed by 'Enter Old PIN', you entered your old PIN incorrectly.

### To Change Your PIN2

Depending on the network you use, some services require that you enter a second PIN, the PIN2.

- Select 'Change PIN2 code' from the 'Access' menu.

Follow the same procedure as described in 'To Change Your PIN' above.

### To Lock the SIM Card

- 1 Select 'Lock card' from the 'Access' menu.
- 2 Press **YES**.
- 3 Enter your PIN and press **YES**.

The message 'Locked' confirms that the card lock is now activated.

### To Unlock the SIM Card

- 1 Select 'Unlock card' from the 'Access' menu.
- 2 Press **YES**.
- 3 Enter your PIN and press **YES**.

The message 'Unlocked' confirms that the card lock is now deactivated.

**Note!** This function only applies if your SIM card allows you to deactivate the card lock.

### If Your SIM Card is Blocked

To unblock the SIM card if you have entered the wrong PIN (or PIN2) three times in a row:

- 1 Press **YES**.
- 2 Enter your PUK (or PUK2) (which you will find in the information from your network operator).

- 3 Enter a new four- to eight-digit PIN (or PIN2).
- 4 Press **YES**.
- 5 Re-enter the new PIN (or PIN2) to confirm it.
- 6 Press **YES**.

**Warning!** If you enter the wrong PUK ten times in succession, your card will be permanently blocked. If this happens, you will have to contact your network operator.

## The Phone Lock

The phone lock protects the phone against unauthorized use in the event of theft. It is not activated when you buy the phone. You should, however, activate it as soon as possible. You should also change the default security code 0000 to any three- to eight-digit personalized code.

There are two levels of locking the phone:

- Full Lock
- Autolock

If the 'Full Lock' is activated, you see the message 'Phone locked' briefly, each time you turn on the phone. The message is followed by the prompt 'Enter lock code'. You then have to enter a security code and press **YES** to be able to use the phone.

If the 'Autolock' is activated, the message 'Phone locked' and the prompt 'Enter lock code' will not appear until a different SIM card is inserted in the phone. After the security code has been entered correctly, the phone can be used with a new SIM card. You are not asked to enter the security code until the original SIM card or a different SIM card is inserted.

### To Change the Security Code

- From the 'Access' menu, select 'Phone lock Change code' and follow the steps described in 'To Change Your PIN'.

## To Lock/Unlock the Phone

- 1 From the 'Access' menu, select 'Phone lock'.  
The current setting 'Full lock', 'Autolock' or 'Unlocked' is shown in brackets.
- 2 Select the required setting.
- 3 Enter the security code and press **YES**.  
'Phone Lock' is displayed together with the new setting.

## Call Barring

The 'Call Barring' service of the cellular network allows you to bar different types of outgoing and incoming calls. This means you can restrict the use of your phone.

**Note!** This service may not be available on all networks or may require a separate subscription.

The following calls can be barred:

- all outgoing calls,
- all outgoing international calls,
- all outgoing international calls except to your home country,
- all incoming calls,
- all incoming calls when you are abroad (when roaming).

To ensure that a call bar is not changed by someone else, a password, which comes with your subscription, is necessary in order to activate or cancel a call bar.

### To Change the Call Barring Status

- 1 From the 'Access' menu, select 'Barring'.  
The first barring option is 'All outgoing calls'. To choose another barring option, use the navigation key.
- 2 Scroll to the option you want, using the navigation key, and press **YES**.

- ③ You now have three options:
- 'Activate', which sets a call bar,
  - 'Get status', which lets you check the status of a call bar,
  - 'Cancel', which cancels the call bar.

Confirm your selection by pressing **YES**.

- ④ Enter your password and press **YES**.

There may be a short delay before the network responds. In the meantime the message 'Please wait' is displayed. This is followed by a message which informs you whether the call bar is activated or not.

**Note!** If you divert incoming calls (see 'Diverting Incoming Calls'), you cannot activate some barring options. Likewise, if you bar calls, you cannot activate some call divert options.

### To Cancel All Call Bars

- ① From the 'Access' menu, select 'Barring'.
- ② Scroll to 'Cancel all', using the navigation key, and press **YES**.

The message 'Please wait' appears, followed by a message that confirms that all call bars are cancelled.

### To Change the Barring Password

The password for the Barring service comes with your subscription. You can easily change the password as often as you like.

- ① From the 'Access' menu, select 'Barring'.
- ② Scroll to the 'Change password' option, using the navigation key.
- ③ Enter the old (current) password and press **YES**.
- ④ Enter the new password and press **YES**.
- ⑤ Enter the new password a second time and press **YES**.

The message 'Please wait' appears, followed by a message that confirms that the password has been changed.

## The Keypad Lock

The Keypad Lock feature helps you to avoid accidental dialling, which can happen if you keep your phone in your pocket. You can choose between manual and automatic keylock.

An icon in the shape of a key (Ⓝ) in the display informs you that the keypad is locked.

**Note!** Calls to the international emergency number 112 can be made when the keypad is locked. If the phone alarm rings, you can turn it off by pressing any key.

The keypad remains locked until you:

- answer an incoming call,
- replace the battery,
- unlock the keypad.

### To Lock the Keypad Manually

- ① Scroll to the 'Keylock' menu, using the navigation key.
- ② Press **YES**.

### To Unlock the Keypad

- Press **LEFT** followed by **YES**.

### The Automatic Keylock

Automatic keylock means that if no keys are pressed in 25 seconds, the keypad will be locked.

To set the automatic keylock:

- ① From the 'Settings' menu, select 'Keylock'.
- ② Choose 'Auto', using the navigation key.
- ③ To confirm your selection, press **YES**.

**Note!** The Keypad lock is always disabled if the phone is connected to vehicle handsfree equipment.

Press  to enter the menu system. See inside the cover.

## Fixed Dialling

Fixed Dialling is a way of restricting outgoing calls. It requires a SIM card that allows fixed numbers to be stored. The fixed numbers are protected by the PIN2.

- The Fixed Dialling function allows calls to be made only to fixed numbers stored on the SIM card. If an attempt is made to call other numbers, the message 'Number not permitted' appears in the display.
- It is possible to store partial numbers, for example an area code, or an area code followed by the first digits common to several numbers. Storing 0123456 allows calls to be made to numbers from 012345600 to 012345699.
- Numbers beginning with the international '+' sign and country code can also be stored, allowing you to make calls from abroad.
- Numbers including question marks can be stored. For example, storing 0123456?0 allows calls to be made to numbers ending with a zero from 0123456700 to 0123456790. To enter a question mark hold down #.
- The Fixed Dialling function does not prohibit calls to the international emergency number 112 and the Service Centre of your network operator. Network services such as Call Divert and Call Barring cannot be used.
- The maximum fixed numbers that can be stored depends on your SIM card.

### To Activate Fixed Dialling

- ➊ From the 'Access' menu, select 'Fixed dial'.
- ➋ Enter the PIN2 and press **YES**.
- ➌ Scroll to 'On', using the navigation key, and press **YES**.

### To Cancel Fixed Dialling

- ➊ From the 'Access' menu, select 'Fixed dial'.
- ➋ Enter the PIN2 and press **YES**.
- ➌ Scroll to 'Off', using the navigation key, and press **YES**.

### To Store Fixed Numbers

- ➊ From the 'Phone book' menu, select 'Fixed numbers'.
- ➋ Scroll to 'Store', using the navigation key, and press **YES**.
- ➌ Enter the PIN2 and press **YES**.
- ➍ Enter the name (optional) and the fixed number in the same way as when storing an ordinary phone number.

### To Edit a Stored Fixed Number

- ➊ From the 'Phone book' menu, select 'Fixed numbers'.
- ➋ Scroll to 'Edit', using the navigation key, and press **YES**.

After you have entered the PIN2, you can change the position number, the name or the fixed number in the same way as with an ordinary phone number.

# Diverting Incoming Calls

If you want to make certain that your incoming calls are taken care of when you are unable to answer them, you can use the Call Divert service to divert them to another phone number.

The Call Divert service lets you:

- divert calls if you are already on the phone.
- divert calls that you do not answer within a specified time limit (operator dependent).
- divert calls if your phone is turned off or if you are unreachable
- divert all incoming calls.

You can also use any combination of the above.

The divert option 'All calls' means that all incoming calls will be diverted to a number specified by you. If you choose to divert all calls, an arrow (↔) is shown in the display.

**Note!** If you activate the 'All calls' divert, all other diverts will automatically be cancelled. They will, however, be activated again when you cancel the 'All calls' divert.

## Activating a Call Divert

- ➊ From the 'Divert' menu, scroll to the required divert option, using the navigation key. The options are 'All calls', 'On busy', 'No reply' and 'Unreachable', depending on your operator.
- ➋ Scroll to the divert option you want, and press **YES**.
- ➌ To select 'Activate', press **YES**.

- ➍ Enter the phone number to which you want your calls to be diverted, including the area code, and then press **YES**.

**Note!** If you used the divert option earlier and then cancelled it, the phone number to which the calls were diverted will be suggested. Press **CLR** if you want to erase this number and enter a new one.

There may be a short delay before the network responds. In the meantime, the message 'Please wait' is displayed. This is followed by the message 'On busy', 'All calls' or 'No reply' – 'Divert ON', depending on which divert option you choose. The selected phone number is also displayed.

The display informs you of any activated call divert each time you turn the phone on.

## Diverting when the Data Menus are On

If you have turned on the 'Data menus', you can set call diverts for your phone, fax and data numbers respectively or for all three together. To divert, proceed as described above.

For the fax and data numbers, there are only two divert alternatives:

- all calls,
- unanswered.

## Checking the Divert Status

---

### To Check the Status of a Certain Call Divert

- 1 From the 'Divert' menu, scroll to the call divert you want, using the navigation key, and press **YES**.
- 2 Scroll to the 'Get status' option.
- 3 To check the status, press **YES**.

The message 'Please wait' appears, followed by either the phone number and 'Active on' if the call divert is activated, or 'Active Off' if it is not activated.

### To Check the Status of All Call Diverts

- From the 'Divert' menu, select 'Check all'.

The message 'Please wait' appears, followed by information about all call diverts, i.e. whether they are activated or not.

## Cancelling Call Diverts

---

### To Cancel a Certain Call Divert

- 1 From the 'Divert' menu, scroll to the required call divert, using the navigation key, and press **YES**.
- 2 Scroll to 'Cancel'.
- 3 To cancel the divert, press **YES**.

The message 'Please wait' appears followed by a message which informs you that the call divert has been cancelled.

### To Cancel All Call Diverts

- From the 'Divert' menu, select 'Cancel all'.

The message 'Please wait' appears, followed by a message which informs you that all call diverts have been cancelled.

# Handling More than One Call

Your Ericsson SH 888 allows you to handle more than one call simultaneously. This means that you can put a call that is in progress on hold, while you make or answer a second call, and then switch between the two calls. See also 'Conference Calls' at the end of this chapter'.

## The Call Waiting Service

### To Activate the Call Waiting Service

To be able to receive a second call, you must activate the 'Call Waiting' service.

- 1 From the 'Access' menu, select 'Call Waiting'.
- 2 Scroll to 'Activate', using the navigation key.
- 3 To activate the call waiting service, press **YES**.

There may be a short delay before the network responds. In the meantime, the message 'Please wait' is displayed. This is followed by the message 'Call Waiting ON'.

### To Cancel the Call Waiting Service

- 1 From the 'Access' menu, select 'Call Waiting'.
- 2 Scroll to 'Cancel', using the navigation key.
- 3 To cancel 'Call Waiting', press **YES**.

With the 'Get status' option, you can check whether the call waiting service is activated or not.

## Receiving a Second Call

If the 'Call Waiting' function is activated, you will hear a tone in the earpiece when a second call is received and the message 'Call wait' will appear in the display.

### To End Current Call and Accept Waiting Call

- 1 Press **NO** to end the current call. The question 'Answer?' appears.
- 2 To answer the waiting call, press **YES**.

### To Put Current Call on Hold and Accept Waiting Call

- To put the current call on hold and to answer the waiting call, press **YES**. The message '1 on hold' appears.

### To Reject Waiting Call

- To reject the waiting call and continue the current call, press 0 followed by **YES**.

The waiting call is cleared. If the caller's network supports it, the caller will hear a busy tone.

**Note!** If 'Divert On busy' is activated, the waiting call is diverted to the number you have specified.

### To Switch Between Two Calls

- To switch between the active call and the call on hold, press **YES**.



## To End the Current Call

- 1 To end the current call, press **NO**. The message 'Retrieve held call?' appears and a beep sounds.
- 2 Press **NO** to end the held call, or press **YES** to return to the held call.

**Note!** If you do not press **YES** or **NO** within three seconds, the message 'Retrieve held call?' disappears from the display. The held call is ended automatically.

**Tip!** You can automatically end the current call and retrieve the held call by pressing 1 followed by **YES**.

## Receiving a Third Call

Provided your 'Call Waiting' function is activated, you may receive a third call when you are engaged in one call and have a second call on hold. You will hear a tone in the earpiece and the message 'Call Wait' appears in the display.

### To Accept the Call

Only one call at a time can be on hold. If you wish to accept the third call, you must end one of the existing calls.

To end the current call and accept the waiting call:

- Press 1, followed by **YES**.  
The waiting call will become active and the held call will remain held.

### How to Reject the Call

- Press 0, followed by **YES**.

The third call is rejected. Provided the caller's network supports this function, the caller will hear a busy tone.

**Note!** If 'Divert On busy' is activated, the waiting call is diverted to the number you have specified.

## To Make a Second Call

- 1 While the first call is in progress, clear the display by pressing **CLR**.
- 2 To put the current call on hold, press **YES**. The message '1 on hold' is displayed.
- 3 Enter the number you wish to call, or recall it from the phone book, and press **YES**.

## Connecting Two Calls – Explicit Call Transfer

If you have one active call and one on hold, it is possible to connect the two calls.

- Press 4 followed by **YES**.

The two calls are now connected to each other, and you are disconnected from both calls.

This service may not be available in all networks. Contact your operator to find out whether your network supports it.

## Conference Calls

The Conference call service allows you to have a joint conversation with up to five people. You may put an individual or a group of conference members on hold while you add other people to the conference call. You may also put conference members on hold while you talk to someone privately.

The Conference Call service may not be available in all networks. Contact your operator to find out whether your network supports it.

### To initiate a Conference Call

- 1 Call the first person you wish to include in the conference call.
- 2 Put this person on hold by pressing **YES**.
- 3 Call the second person you wish to include in the conference call.
- 4 Press 3, followed by **YES**, to include the two persons in the conference.

You can put the conference group on hold and then add a third member by repeating steps 2 to 4. It is possible to add up to five members in this way.

**Note!** In the display, the last called number is referred to as call number one, the one before as number two etc.

### To Have a Private Conversation

If you wish to have a private conversation with one of the members, you can put the other members on hold. To do this:

- 1 Press 2.
- 2 Press the number of the member you want to have a private conversation with. For example, if you wish to talk to member number three, press 3.
- 3 Press **YES**.

To join the member to the conference call again:

- Press 3 and then **YES**.

### To Release one of the Members in a Conference Call

- 1 Press 1.
- 2 Press the number of the member you want to release. For example, if you wish to release member number three, press 3.
- 3 To release the member, press **YES**.

### Making a Call while a Conference Call is in Progress

It is possible to make a call while you are participating in a conference call. To do this:

- 1 To put the conference call on hold, press **YES**.
- 2 Enter the number you wish to dial and press **YES**

To switch between the new call and the conference call:

- Press **YES**.

To end the new call and return to the conference call:

- Press 1, then **YES**.

See chapter 'Handling More than One Call' for more details.

### To End a Conference Call

- To end the conference call, press **NO**.

# Handsfree Calling

By using the Ericsson portable or vehicle handsfree solutions, you can be on the phone without having to use your hands to hold it.

The SH 888 allows you to change the default settings for the handsfree-related functions so that they fit your own requirements.

## Selecting Answering Mode

The submenu 'Answering mode' includes two functions: 'Any key' and 'Auto', which are useful when you use the phone with handsfree equipment.

- The 'Any key' function:  
If you use the phone with handsfree equipment and this function is turned on, you can answer an incoming call by pressing any key, except the **NO** key.
- The 'Auto' function:  
If you choose the automatic answering mode, an incoming call will be answered automatically after one ring signal, if the phone is used with handsfree equipment.

To select Answering Mode:

- ❶ From the 'Settings' menu, select 'Answering mode'.
- ❷ Choose 'Any key' or 'Auto', using the navigation key.
- ❸ To change the setting of the function you have chosen, press **YES**.
- ❹ To confirm your setting, press **YES** again.

## Other Handsfree-Related Settings

Apart from the settings mentioned above, you can change the following settings when using handsfree equipment:

- 'Ring level'
- 'Ear volume'
- 'Ring type'
- 'Light'

Each of these settings can be specified separately when you have your SH 888 connected to handsfree equipment and when you use the phone as a handheld unit. This means that if you make one of these settings when the phone is connected to handsfree equipment, the settings when it is handheld are not affected and vice versa.

To change a setting:

- ❶ Connect the phone to the handsfree equipment.
- ❷ Change the setting according to the instructions in the chapter 'Personalizing Your Phone'.

# Personalizing Your Phone

The Ericsson SH 888 is much more than just another mobile phone. It is your companion in both professional and private life. As such, you most certainly want to adjust the phone to your preferences.

You can do so by composing your own ring signal, changing the key sound or changing the message signal, among other things.

This chapter contains all the information you need to get that little extra out of your phone.

## Personal Settings

The 'Settings' menu includes a number of functions which lets you adapt your phone to your own personal needs in different situations. Note that some of the settings depend on if you have external equipment (e.g. handsfree equipment) connected to your phone or not.

### Changing the Earpiece Volume

- 1 From the 'Settings' menu, select 'Ear volume'.
- 2 Use the navigation key or the volume keys at the side of the phone to adjust the volume.
- 3 When you reach the desired volume, press **YES**.

**Tip!** During a call you can use the volume keys at the side of the phone to adjust the volume.

**Note!** You can have independent volume settings when you use the phone as a handheld unit and when you use it with various handsfree equipment. This means that if you set the earpiece volume when the phone is connected to handsfree equipment, the volume setting

when the phone is handheld is not affected and vice versa.

### To Reset the Phone

It is possible to reset all menu settings to default. To do this:

- 1 From the 'Settings' menu, select 'Master reset'.
- 2 Enter the phone lock code. (The default code is 0000.)
- 3 Press **YES**.

### To Display Your Phone Number

When you turn on your phone, your phone number will be displayed, provided it can be retrieved from your SIM card. If not, you can enter it yourself.

- 1 From the 'Settings' menu, select 'Phone no'.
- 2 Enter the number.
- 3 Press **YES**.

**Note!** If your SIM card allows it, you can also enter your fax and/or data number.

### Changing the Greeting Text

When you turn on your phone, a greeting text appears in the display. Instead of the default greeting, you can have your phone display a welcome greeting that you write yourself. However, some operators may not allow the greeting text to be changed.

To enter your own greeting:

- 1 From the 'Settings' menu, select 'Greeting'.
- 2 Scroll to 'New text', using the navigation key.
- 3 Press **YES**.

Press  to enter the menu system. See inside the cover.

- 4 Write your new greeting, using the numeric keys. For information on how to enter letters, see chapter 'The Phone Book'.
- 5 To confirm your new greeting, press **YES**.

**Note!** The greeting function also lets you turn the greeting text off.

### Setting the Minute Minder

When the minute minder is activated, you hear a beep once every minute, while you are on the phone.

To set the minute minder:

- 1 From the 'Settings' menu, select 'Min minder'.
- 2 Choose between 'On' and 'Off', using the navigation key.
- 3 To confirm your selection, press **YES**.

### To Change the Display Light

The display light can be set to automatic, turned off or turned on.

In automatic mode, the display light is turned off automatically 20 seconds after the last key is pressed. It is turned on again when a key is pressed or when a call or message is received.

To set the display light:

- 1 From the 'Settings' menu, select 'Light'.
- 2 Scroll to the desired display light setting, using the navigation key, and press **YES**.

**Note!** You can have one setting when the phone is used as a handheld unit and another when the phone is used with a handsfree kit, powered from an external source. For example, if you place the phone in a vehicle handsfree holder, you can set the display light always to be on.

### To Select Key Sound

You can choose whether to hear clicks, tones or nothing (silent) when you press the keys.

- 1 From the 'Settings' menu, select 'Key sound'.
- 2 Scroll to the desired key sound, using the navigation key, and press **YES**.

**Note!** The only sound available for the side keys is the click sound.

### Changing the Message Signal

You can choose whether to hear clicks, tones or nothing (silent) when you receive a text message (SMS).

- 1 From the 'Settings' menu, select 'Mail alert'.
- 2 Scroll to the sound you want to hear when you receive a message, using the navigation key.
- 3 To confirm your selection, press **YES**.

### Changing the Ring Type

You can choose ring type from a list of different sounds and melodies. You can also compose your own melody (see below) by entering notes with the keypad.

To choose one of the pre-programmed ring types:

- 1 From the 'Settings' menu, select 'Ring type'.
- 2 Scroll with the navigation key until you find the ring signal that you want. If you do not wish to disturb other people, use the volume keys on the side of the phone to scroll silently.
- 3 When you reach the desired ring type, press **YES**.

**Note!** If the 'Data menus' are turned on (see chapter 'Communicating via the Modem'), you can set the ring signal type for speech (the display shows 'Phone' in the middle row), fax and data calls respectively. If you have the Two Line service (Alternate Line service), you can also set different ring types for the two lines.

## Composing Your Own Ring Signal

- 1 From the 'Settings' menu, select 'Edit Melody'.
- 2 Clear the display by pressing **CLR**.
- 3 Use the keypad to enter notes. The keypad now works as a keyboard. Press and hold a key to enter a long note. Press 0 to increase the note one octave.

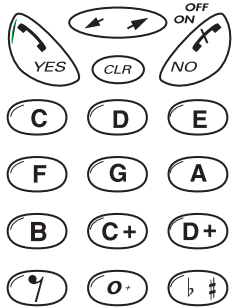

- 4 To listen to your melody, press **YES**. If you want to save it, press **YES** again. If not, press **NO** and continue editing.

## The Ring Signal Level

The Ring level setting allows you to specify the level:

- when the phone is handheld.
- when the phone is connected to handsfree equipment.
- when the phone is connected to a vibrating call alert device.

To set the ring signal level:

- 1 If necessary, connect the phone to the external equipment.
- 2 Scroll to the 'Ring level' menu, using the navigation key, and press **YES**.

- 3 Use the navigation key to set the ring signal level.
  - Pressing **RIGHT** increases the volume.
  - Pressing **LEFT** decreases the volume.The phone will ring once with the actual setting as you press the navigation key, except for the 'Off' and 'Step' settings.
- 4 To save the setting, press **YES**.

**Tip!** Use the side keys to change the ring level silently.

## Time and Date

The 'Clock' menu lets you set the time and date. It also lets you activate the alarm function.

The time is shown continuously at the bottom of the display when the phone is in standby mode.

### The Clock

To change the time format:

- 1 From the 'Clock' menu, select 'Clock mode'.
- 2 Select the clock mode you want, using the navigation key.
- 3 Press **YES**.

To set the clock:

- 1 From the 'Clock' menu, select 'Set clock'.
- 2 Enter the time in hours and minutes.
- 3 Press **YES**.

If you select the 12-hour format in the 'Clock mode' function, you can alternate between am and pm by pressing #.

### The Date

It is possible to have the date displayed in the middle of the display when the phone is in standby mode.

Press  to enter the menu system. See inside the cover.

To set the date format:

- ➊ From the 'Clock' menu, select 'Date mode'.
- ➋ Scroll to the date format you want, using the navigation key.
- ➌ To select a date format, press **YES**.

To set the date:

- ➊ From the 'Clock' menu, select 'Set date'.
- ➋ Enter the year (two digits).
- ➌ Press **YES**.
- ➍ Enter the month and day in the same way.
- ➎ To confirm your setting, press **YES**.

# Other Useful Features

Today's networks are full of advanced features that can help you in your daily life. You will access and benefit from all of them, easily and conveniently, with your Ericsson SH 888, which is designed and prepared to be the best tool available for that kind of services.

This chapter guides you through these features. Please note that some of them are operator dependent. Contact your operator for information on which services you have access to.

## The Answering Service

The Answering service of your network allows callers to leave a voice message when you cannot, or do not, wish to answer your calls.

**Note!** This service may not be available in all networks and may require a separate subscription.

The 'Voice mail' function makes it easy to call your answering service to listen to recorded voice messages. You must activate the 'Voice mail' function before using it.

### Activating the Voice Mail

To enter the number to the answering service:

- 1 From the 'Mail' menu, select 'Set VoiceM'.
- 2 Scroll to 'New number', using the navigation key, and press **YES**.
- 3 Enter the new number and press **YES**.

To activate the Voice Mail function:

- 1 From the 'Mail' menu, select 'Set VoiceM'.

- 2 Scroll to 'On', using the navigation key and press **YES**.
- 3 Enter the number of your answering service.
- 4 To activate the function, press **YES**.

To change the number of the answering service:

- 1 From the 'Mail' menu, select 'Set VoiceM'.
- 2 Scroll to 'New number', using the navigation key, and press **YES**.
- 3 Enter the new number and press **YES**.

### To Call the Answering Service

When you receive a voice mail, this is indicated in the display by the text 'Voicemail Check?'. You can now check your message by pressing **YES**.

If you press **NO**, you can call the answering service at any time later on to listen to your recorded messages. To do this:

- From the 'Mail' menu, select 'Voice mail' and press **YES**.

The phone will automatically call your voice mail. Follow the instructions given to you by your operator's answering service.

Whenever you have a waiting voice mail, a symbol is shown at the bottom of the display.

Further information about the use of the answering service is found in the operating instructions supplied by your network operator.

**Tip!** You can also call your voice mail number by pressing and holding the 1 key in standby mode.

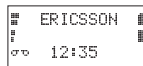
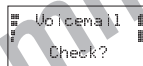

Press  to enter the menu system. See inside the cover.



## To Turn Off the Voice Mail

- 1 From the 'Mail' menu, select 'Set VoiceM'.
- 2 Select 'Off' and press **YES**.

## The Call Time/Call Cost

---

When you are on the phone, the display shows the duration of a call.

By using the 'Call info' function in the 'Settings' menu you can have the time displayed for all calls, both incoming and outgoing. You can also have the call cost or the number of call units displayed by selecting the 'Cost' option, provided your network and your SIM card support this feature.

### Call Information

To select what call information you want to be displayed in the 'Info' menu:

- 1 From the 'Settings' menu, select 'Call info'.
- 2 Choose from 'Time:Outg.', 'Time:All' and 'Cost'.
- 3 Confirm your selection by pressing **YES**.

### To Check Time or Cost of the Last Call

You can check the time/cost of the last incoming (or outgoing) call with the 'Last call' option in the 'Info' menu.

- 1 From standby, scroll to the 'Info' menu, using the navigation key.
- 2 Press **YES**.
- 3 Depending on the setting in the 'Call info' function in the 'Settings' menu, you can use the navigation key to check:
  - The elapsed time of the last outgoing call.
  - The elapsed time of the last incoming call provided you have chosen the 'Time:All'

option in the 'Call info' function in the 'Settings' menu.

### To Check Total Call Time or Call Cost

- 1 From the 'Info' menu, select 'Tot calls'.
- 2 Press **YES**.

Depending on the settings in the 'Call info' function in the 'Settings' menu, you can check:

- The elapsed time of all outgoing calls.
- The elapsed time of all incoming and outgoing calls.
- The cost (or the number of call units) of all incoming and outgoing calls.

### To Reset the Total Call Time/Cost Meter

- 1 From the 'Info' menu, select 'Tot calls'.
- 2 Press **YES**. The message 'Reset?' appears.
- 3 To reset the meter, press **YES**.

**Note!** If you choose the call cost option you must enter your PIN2 to reset the meter.

### To Determine the Call Cost

This function only appears if you have selected the 'Cost' option in the 'Call info' function in the 'Settings' menu.

- From the 'Info' menu, select 'Price'.

The 'Units' option means that the number of call units will be displayed during a call, and in the 'Last call' and 'Tot calls' functions.

The 'Price' function lets you enter and vary the price per call unit. The price entered is stored on your SIM card.

### To Enter the Price per Call Unit

- 1 From the 'Settings' menu, select 'Call info'.

- 2 Scroll to 'Cost', using the navigation key, and press **YES**.
- 3 To exit to standby mode, press **CLR**.
- 4 From the 'Info' menu, select 'Price Units' and press **YES**. 'New Price' appears.
- 5 Press **YES**.
- 6 Enter the code for the desired currency, for example GBP for Pound Sterling, and press **YES**.
- 7 Enter the price per call unit, for example 0.5, and press **YES**. To enter the decimal point, press #.
- 8 Enter your PIN2. (The PIN2 prompt may not appear in some networks.)

### To Revert to Displaying Call Units

- 1 From the 'Info' menu, select 'Price'.
- 2 To select the 'Units' option, press **YES**.
- 3 To revert to displaying call units, press **YES**.

### To Set a Credit Limit for Calls

Provided both your network and your SIM card support this feature, you can enter a total amount of money that can be used for making calls. This could be useful when you, for example, lend your phone to someone, and do not want their call costs to exceed an amount specified by you. After a call is made, the cost is deducted from this amount. When the amount reaches zero, no more calls can be made.

- 1 From the 'Info' menu, select 'Credit'.
- 2 To select 'New credit', press **YES**.
- 3 Enter the amount: for example, 30 pounds.
- 4 Press **YES**.
- 5 Enter your PIN2.
- 6 Press **YES**.

## The Two Line Service

Two voice lines with different phone numbers, Line 1 and Line 2, may be assigned to your phone. This is useful if you, for example, want to have one number for your business calls and one for your private. The ability to receive and send text messages (SMS), is only available on Line 1.

The Two Line service (also called Alternate Line Service, ALS) may not be available on all networks and may require a separate subscription.

### Selecting a Line

The line currently selected is indicated in the display with the letter 'L' and a digit. For example, if line two is selected, you will see 'L2' in the display.

To change to the line that is not currently selected:

- 1 Scroll to the 'Change to' menu.
- 2 To change to the line displayed in the bottom row, press **YES**.



From now on, all outgoing calls are made on the selected line. You can, however, receive calls on both lines.

**Note!** Instead of accessing the menu system, you can press and hold the 2 key to change line, provided the phone is in standby mode. Clear the display first, using the **CLR** key.

### Receiving a Call on Line 1 or Line 2

When someone calls you, the question 'Answer?' is replaced by 'Line1?' or 'Line2?' depending on which line you have selected.

**Note!** If you are engaged in a call on one line, you must end that call first before answering the call on the other line.

Press  to enter the menu system. See inside the cover.

## Different Settings for Each Line

You can have different settings for each line: for example, the tone of the ring signal, call diverts, call bars and call waiting function.

The call meters in the 'Info' menu show the call times (call costs) for the line currently selected.

## Changing the Name of the Two Lines

Your SH 888 allows you to personalize the names of the two lines. You might, for example, want to call Line 1 'Private' and Line 2 'Work'. To change the name of Line1:

- 1 From the 'Settings' menu, select 'Line 1 Tag' and press **YES**.
- 2 Enter the name (maximum twelve characters), using the numeric keys and press **YES**.

To change the name of Line 2, select 'Line 2 Tag' instead.

## Calling Card or Credit Card Calls

When making international or long distance calls, you may not want your operator to charge you for these calls on your normal account. If you have a credit card or a calling card, you may want to redirect the charges to one of those accounts instead. Your SH 888 is all set for making this procedure as easy as possible for you.

You can store two separate card numbers in your phone. These numbers are protected by a four- to eight-digit security code that you choose yourself. The default code is 0000.

In order to be able to make Calling card calls, you have to activate this function.

## Activating the Calling Card Feature

- 1 From the 'Access' menu, select 'Call cards security' and press **YES**.
- 2 Enter your security code and press **YES**. The default code is 0000.
- 3 Scroll to 'Call cards', using the navigation key, and press **YES**.
- 4 Scroll to 'On', using the navigation key, and press **YES**.

The Call card function is now activated and the sub-menu 'Call card numbers' will be visible in the 'Phone book' menu.

## To Change Security Codes

- 1 From the 'Access' menu, select 'Call cards security' and press **YES**.
- 2 Enter your security code and press **YES**. The default code is 0000.
- 3 Scroll to 'Change code', using the navigation key, and press **YES**.
- 4 Enter your new code and press **YES**. The code can consist of four to eight digits.
- 5 Confirm your new code, when 'Repeat new code' appears in the display, and press **YES**.

Your security code is now changed.

## Storing Credit or Calling Card Numbers

Your Ericsson SH 888 allows you to store two calling card numbers in the phone book menu.

This submenu is only visible if the Call card function is activated in the 'Access' menu.

To store a calling card number:

- 1 From the 'Phone book' menu, select 'Call card numbers' and press **YES**.

- ② Enter your security code and press **YES**. The default code is 0000. To change security codes, see above.
- ③ Select card position (Card 1 or Card 2), using the navigation key, and press **YES**.
- ④ Enter the access number (the phone number) to the calling card server. The numbers are entered in the same way as in the ordinary Phone book.
- ⑤ Press the navigation key.
- ⑥ Enter the verification code to your calling card server.
- ⑦ To store the calling card number, press **YES**.

**Note!** Since the dialling order may vary between calling card servers, you can change the order yourself. Use the \* or # key, when the 'Called no.' row flashes.

Dialling order means whether you have to dial your verification code before or after the number you want to dial.

### Selecting the Card You Want To Use

If you have stored two card numbers, you must select which card you wish to use before making a Calling/Credit card call.

- ① From the 'Phone book' menu, select 'Call card numbers'.
- ② Enter your security code and press **YES**. The default code is 0000.
- ③ Scroll to the card you wish to use, using the navigation key, and press **YES**  
Your settings for the card appear.
- ④ To select the card, press **YES**.

**Note!** If you only use one card number, this selection will not have to be repeated every time you wish to make a Calling/Credit card call.

### Making a Credit or Calling Card Call

- ① Enter the number you wish to dial, or retrieve it from the Phone book.
- ② To set up the call as a Credit/Calling Card Call, press and hold **YES**.

The access number to the calling card server is called and during the connecting phase, you are prompted to send the called number (the number or the person you want to call) and the verification code, in the order chosen by you (see above).

To send the called number and the verification code during the connecting phase, press **YES** when the display shows 'Send', or wait a few seconds and your Ericsson SH 888 will send them automatically.

### Area Information

The ordinary Short Message Service can be defined as a personal service with messages specifically and exclusively directed to you. The Area Information (AI) is another type of text message which is sent to all subscribers in a certain cell of a network at the same time.

For example, the information may be a local road report or a local taxi phone number.

**Note!** This feature may not be available in all networks.

### To Turn On Area Information

- ① From the 'Mail' menu, select 'Area info'.
- ② Press **YES**.
- ③ Scroll to 'On', using the navigation key, and press **YES**.

You can now see Area information messages in your display.

## To Turn Off Area Information

- 1 From the 'Mail' menu, select 'Area info'.
- 2 Press **YES**.
- 3 Scroll to 'Off', using the navigation key, and press **YES**.

## Area Information Message Types

Each type of Area Information message is identified by a three-digit code. At present, the following message types exist:

Code	AI Message Type
000	Index
010	Flashes
020	Hospitals
022	Doctors
024	Pharmacy
030	Long-distance road reports
032	Local road reports
034	Taxis
040	Weather
050	District (base station identity)
052	Network information
054	Operator services
056	Directory enquiries (national)
057	Directory enquiries (international)
058	Customer care (national)
059	Customer care (international)

For information about the AI services you can use, please refer to the information supplied by your network operator.

## Area Information Message List

You can decide which types of area information messages you wish to receive. The phone's 'Area Info' list can hold up to 20 codes.

To insert an Area Information code:

- 1 From the 'Mail' menu, select 'Area info'.
- 2 Press **YES**.
- 3 Scroll to 'Edit list', using the navigation key, and press **YES**.

The digits to the left indicate the position in the list. You can scroll forwards and backwards through the list with the navigation key.

- 4 To insert a code, scroll to the first empty location, using the navigation key. Press **YES**.
- 5 Enter the new code. (You only need to enter 40 for 040, since the phone adds the leading zero automatically.)

To erase or replace a code:

- 1 From the 'Mail' menu, select 'Area info'.
- 2 Press **YES**.
- 3 Scroll to 'Edit list', using the navigation key, and press **YES**.
- 4 Scroll to the code you wish to erase, and press **YES**.
- 5 The message 'Erase?' appears.
  - If you want to erase this code, press **YES**.
  - If you want to replace the code, press the navigation key **RIGHT** once, followed by **YES**. Then enter the new code and press **YES**.

## To Receive Area Information

When you receive Area information, the message is stored in the phone memory. Please note that the phone only stores one message per code. This means that the message stored previously in a specific code will be erased.

Provided 'Area info' is turned on, you can read the messages with the 'Area messages' function in the mail menu.

- 1 From the 'Mail' menu, select 'Area messages'.

- 2 Scroll from one message to another by using the navigation key.
- 3 To select a message, press **YES**.

## The Alarm

---

The phone has an alarm function. When it is activated, an icon in the shape of a bell (🔔) is shown next to the current time in the display.

The alarm rings at the set time even if the phone is turned off. The illumination of the keys and the display will flash. The volume of the alarm signal depends on the setting of the ring signal.

The alarm will ring for 60 seconds and will be repeated every nine minutes if you do not turn it off. After 60 minutes, the repeat function will be turned off.

To set the alarm:

- 1 From the 'Clock' menu, select 'Set alarm'.
- 2 Scroll to the 'New time' option, using the navigation key.
- 3 Press **YES**.
- 4 Enter the time in hours and minutes.
- 5 Press **YES**.

**Note!** If you choose the 12-hour format in the 'Clock mode' function you can alternate between am and pm by pressing \* and #.

To turn the alarm off:

- 1 Press any key to turn the alarm off when it sounds.
- 2 If you do not want the alarm to be repeated, press **YES**.

To turn the alarm function off:

- 1 From the 'Clock' menu, select 'Set alarm'.
- 2 Scroll to 'Off', using the navigation key.
- 3 Press **YES**.

## The Calculator

---

The phone's built-in calculator can add, subtract, divide and multiply.

An example of how to use the calculator:

In this example we are going to divide 134 by 32.

- 1 Scroll to the 'Calculator' menu and press **YES**.
  - 2 Enter 134.
  - 3 Scroll with the navigation key to the division sign (/), and press **YES**.
  - 4 Enter 32.
  - 5 Scroll with the navigation key to the equal sign (=) and press **YES** to get the answer.
- You can also press # to get the answer.
- 6 To clear the display, press **CLR**.

To enter a decimal point:

- Press \*.

To multiply:

- Press \* twice.

# Guidelines for Safe and Efficient Use

## General

---

Your mobile phone is a radio transmitter and receiver. When the phone is turned on, it receives and transmits radio frequency (RF) energy. Depending on the type of mobile phone you have bought, it operates in different frequency ranges and employs commonly used modulation techniques. The system that handles your call when you are using your phone, controls the power level at which your phone transmits.

## Exposure to Radio Frequency Energy

---

The International Commission on Non-Ionizing Radiation Protection (ICNIRP), sponsored by the World Health Organization (WHO), published a statement in 1996 which sets limits for exposure to RF fields from hand-held mobile phones. According to this statement, which is based on the available body of research, there is no evidence that mobile terminals meeting the recommended limits can cause any adverse health effects. All Ericsson telephones conform to the ICNIRP recommendations and international exposure standards, such as:

- CENELEC European Pre-standard ENV50166-2
- ANSI/IEEE C95.1-1992 (USA, Asia-Pacific)

If you want to limit RF exposure even further, you may choose to control the duration of your calls and operate your phone in the most power efficient manner.

## Efficient Phone Operation

---

How to use your phone for optimum performance with minimum power consumption:

- Hold the phone as you would any other telephone. While speaking directly into the mouthpiece, angle the antenna in a direction up and over your shoulder. If the antenna is extendable/retractable, it should be extended during a call.
- **Do not** hold the antenna when the phone is in use. Holding the antenna affects call quality, may cause the phone to operate at a higher power level than needed and shorten talk and standby times.

## Antenna Care and Replacement

---

- **Do not** bend the antenna since it is sensitive and this will reduce its performance.
- **Do not** use the phone with a damaged antenna. Take your phone to a qualified service centre for repair. Use only the designated Ericsson antenna.
- **Do not** use an antenna designed for any other type of telephone than the one you have bought. Unauthorized antennas, modifications, or attachments could damage the phone and may violate the appropriate regulations.

## Driving

---

Check the laws and regulations on the use of telephones in the areas where you drive.

If you are going to use your mobile phone while driving:

- Give full attention to driving.
- Use hands-free operation, if available.
- Pull off the road and park before making or answering a call if driving conditions so require.

RF energy may affect some electronic systems in motor vehicles. In addition, some vehicle manufacturers forbid the use of mobile phones in their vehicles. Check with your vehicle manufacturer's representative to be sure your phone will not affect the electronic systems of your vehicle.

## Electronic Devices

Most modern electronic equipment, for example equipment in hospitals and cars, is shielded from RF energy. However, RF energy from telephones may affect some electronic equipment.

**Turn off** your phone in health care facilities when regulations posted in the areas instruct you to do so.

**Do not** use your mobile phone near medical equipment without requesting permission.

Mobile telephones may affect the operation of some implanted cardiac pacemakers, equipment for people with hearing impairments and other medically implanted equipment. Pacemaker patients should be aware that the use of a mobile phone very close to a pacemaker may cause the device to malfunction. Avoid placing the phone over the pacemaker, i.e. in your breast pocket. When using the phone, place it at your ear opposite the pacemaker. If a minimum distance of 15 cm is kept between the phone and the pacemaker, the risk of interference is limited. Contact your cardiologist for more information.

## Aircraft

- **Turn off** your phone before boarding any aircraft.
- **Do not** use it on the ground without crew permission.

To prevent interference with communication systems, you must not use your phone while the plane is in the air.

## Power Supply

- Connect AC (Power supply) only to designated power sources as marked on the product.
- To reduce risk of damage to the electric cord, remove it from the outlet by holding onto the AC adapter rather than the cord.
- Make sure the cord is located so that it will not be stepped on, tripped over or otherwise subjected to damage or stress.
- To reduce risk of electric shock, unplug the unit from any power source before attempting any cleaning, then use a soft, damp cloth.

## Children

**Do not** allow children to play with your phone since they could hurt themselves or others or accidentally damage the phone.

## Blasting Areas

**Turn off** your mobile phone when in a blasting area or in areas posted 'turn off two-way radio' to avoid interfering with blasting operations. Construction crews often use remote control RF devices to set off explosives.



## Potentially Explosive Atmospheres

---

**Turn off** your phone when in any area with a potentially explosive atmosphere. It is rare, but your phone or its accessories could generate sparks. Sparks in such areas could cause an explosion or fire resulting in bodily injury or even death.

Areas with a potentially explosive atmosphere are often, but not always, clearly marked. They include fueling areas, such as petrol stations, below deck on boats, fuel or chemical transfer or storage facilities, and areas where the air contains chemicals or particles, such as grain, dust, or metal powders.

**Do not** transport or store flammable gas, liquid, or explosives in the compartment of your vehicle which contains your phone and accessories.

## Product Care

---

- **Do not** expose your mobile phone to moisture or extreme temperatures.
- **Do not** use any other accessories than Ericsson originals. Failure to do so may result in loss of performance, fire, electric shock or injury, and will void the warranty.
- **Do not** attempt to disassemble the product. Doing so will void warranty. This product does not contain consumer serviceable components. Service should only be performed by Authorized Service Centres.

Press  to enter the menu system. See inside the cover.

# Warranty Conditions

If your Ericsson product requires warranty service you should return the product to the dealer/retailer from whom it was purchased. If your Ericsson product requires warranty service when you are abroad, the service is available in those countries listed on your International Warranty Certificate.

In the event of difficulty, details of our authorized service network are available from your local Ericsson subsidiary.

## Our warranty

Ericsson warrants this product as being free of defects in material, design and workmanship at the time of original purchase and for a period of twelve (12) months immediately thereafter.

## What We Will Do

If, during the period of the warranty, this product malfunctions in normal use and service due to defective design, materials or workmanship Ericsson will repair or replace, at its discretion, the product under the conditions stated below.

Ericsson subsidiaries, authorised distributors or authorised service centres in the countries listed on your International Warranty Certificate will repair or replace this product in accordance with the terms and conditions stipulated in these conditions of the warranty. Certain products may not be available in certain countries and in this event, a similar product will be delivered.

## Conditions

- 1 The warranty will be granted only if the original warranty certificate issued to the purchaser by the dealer is presented, and if the said warranty certificate stipulates the serial number of the purchased product and the date of purchase of the product. Ericsson reserves the right to refuse warranty service if this information has been removed or amended after the original purchase of the product. The original receipt/invoice will only be accepted as a proof of purchase when presented to the dealer from whom the product was purchased.
- 2 The warranty is not applicable in circumstances other than defects in material, design and workmanship. The warranty does not cover the following:
  - Periodic checks, maintenance, repair and replacement of parts due to normal wear and tear, exchange of faulty batteries or upgrading of software due to changes in network parameters.
  - Damage to the product resulting from:
    - Abuse or misuse, including but not limited to failure to use the product for its normal purposes or in accordance with Ericsson's instructions for use and maintenance of the product, or the installation or use of the product in a manner inconsistent with the technical or safety standards in force.
    - Repairs performed by non-authorized service workshops, or opening of the product by non-authorized persons.

- Accidents, acts of God or any cause beyond the control of Ericsson, including but not limited to lightning, water, fire, public disturbances and improper ventilation.
- ③ This product will not be considered defective in materials, design or workmanship if it needs to be adapted, changed or adjusted to conform to national or local technical or safety standards in force in any country other than that for which the product was originally designed and manufactured. This warranty shall not reimburse such adaptations, changes or adjustments, or attempts to do so, whether properly performed or not, nor any damage resulting from them, nor any adaptation, change or adjustment to upgrade the product from its normal purpose as described in the product manual without the prior written consent of Ericsson.
- ④ Repair or replacement under the terms of this warranty shall not give a right to an extension to, or a new commencement of, the period of warranty. Repair or replacement under the terms of this warranty may be fulfilled with functionally equivalent reconditioned units. Replaced faulty parts or components will become the property of Ericsson.
- ⑤ This warranty does not affect the purchaser's statutory rights under applicable national legislation in force, nor the purchaser's rights against the dealer arising from the sales/purchase contract.

In the absence of applicable national legislation this warranty will be the purchaser's sole and exclusive remedy. Ericsson, its subsidiaries and distributors shall not be liable for any incidental or consequential damages for breach of any express or implied warranty relating to this product.

# Index

## A

Aircraft	60
Alarm	58
set the alarm	58
turn the alarm function off	58
turn the alarm off	58
Alternate line service (ALS)	54
answered calls memory	11
Calling Line Identification service (CLI)	11
clear memory	11
recall number	11
Answering Mode	47
Answering Service	52
check voice mail	52
Voice Mail	52
antenna	
care and replacement	59
Area Information	56
Message List	57
Message Types	57
Receive Area Information	57

## B

Battery	4
Attach the Battery	4
Charge the Battery	4
low battery alarm	6
nickel cadmium type batteries	5
nickel metal hydride battery	5
Remove the Battery	4

## C

Calculator	58
Call Barring	
cancel call bars	40
change password	40
change status	39
Call Information	53
Call Cost	53
Call Time	53
Credit Limit	54
Price per Call Unit	53
Call Waiting Service	44
Activate Call Waiting Service	44
Cancel Call Waiting Service	44
Calling Line Identification (CLI) service	12, 18
hide your phone number	12, 18
show your phone number	12, 18
Calls	9
Answer	10
Domestic	9
International	9
Making	9
Receiving	10
Rejecting	10
Capacity	2
Charger	4
Connect	4
Disconnect	5
Children	60
Clock	50
Conference Calls	45
Connecting Two Calls	45

Coverage	2
Credit Card Calls	55

## D

Data calls	30
Data Menus	26
Date	50
Display	0
Display Language	7
Reset to English	8
Display Light	49
Display Your Phone Number	48
Diverting Incoming Calls	42
Activating a Call Divert	42
Cancelling Call Diverts	43
Checking the Divert Status	43
Diverting when the Data Menus are On	42
Driving	59
DTMF tones	13

## E

Earpiece Volume	13, 48
Efficient Phone Operation	59
Electronic Devices	60
Emergency calls	7, 9
Entering Characters	
Check the First Characters	16
Enter Small Letters	16

Erasing a Message .....	24
Erasing a Phone Number .....	19
Exposure to Radio Frequency Energy .....	59

## F

Fax calls .....	30
Fixed Dialling .....	41
Activate .....	41
Cancel .....	41
Edit Fixed Numbers .....	41
Store Fixed Numbers .....	41
Frequencies .....	2

## G

Greeting Text .....	48
GSM 900 .....	2

## H

Handsfree Calling .....	47
Handsfree-Related Settings .....	47
hiding your phone number .....	12, 18

## I

international emergency number .....	9
International Numbers .....	15
country code .....	15
international dialling prefix .....	15

## K

Key Sound .....	49
Keypad Lock .....	40
Automatic .....	40
Manual .....	40
Unlock .....	40

## L

Language .....	7
last dialled numbers .....	10
Light .....	49

## M

Menu System .....	14
Message Signal .....	49
Minute Minder .....	49
Missed calls .....	11
Who Called .....	11
Mobile Office Suite .....	33
Installing the Mobile Office Suite .....	33
The Message Manager .....	33
The Phone Book Manager .....	33
Uninstalling the Mobile Office Suite .....	34

## Mute

Microphone .....	13
ring signal .....	10

## N

Networks .....	35
Search .....	35
Select .....	35

## O

Operators .....	2
-----------------	---

## P

PCN .....	2
Personal Identity Number (PIN) .....	2
Personal Unblocking Key (PUK) .....	2
Phone Book .....	15
Edit .....	19

Entering Characters .....	16
Ericsson Mobile Office Suite software .....	15
name recall .....	17
Phone Book Memories .....	15
position recall .....	18
Store a Phone Number .....	16

PIN .....	2
Change PIN .....	38

PIN2 .....	2
Change PIN2 .....	38

Potentially Explosive Atmospheres .....	61
---	----

Power Supply .....	60
--------------------	----

Product Care .....	61
--------------------	----

PUK .....	2
-----------	---

## R

Reading a Message .....	23
-------------------------	----

Recalling a Phone Number .....	17
Using the Name .....	17
Using the Position .....	18

Receiving Fax and Data Calls .....	31
Multi Numbering .....	31
Single Numbering .....	31

Redialling a Number .....	10
Automatic Redialling Function .....	10
Redial Previously Called Numbers .....	10

Replying to a Message .....	24
-----------------------------	----

Reset the Phone .....	48
-----------------------	----

## Ring signal

changing ring type .....	49
Composing your own ring signal .....	50

Ring Signal Level .....	8, 50
handsfree equipment .....	8
To mute the ring signal .....	10
vibrating call alert device .....	8

Roaming	
International	2

## **S**

Scratch Pad	13
Security	38
Call Barring	39
Card Lock	38
Keypad Lock	40
Phone Lock	39
security code (PIN)	2
Sending Messages	23
SIM Card	
If Your SIM Card is Blocked	38
Insert the SIM Card	3
Lock the SIM Card	38
Unlock the SIM Card	38
Speech then Fax Calls	31
speed dialling	17
Subscriber Identity Module (SIM)	2
Subscription	2

## **T**

Text Messages	21
Changing Message Types	22
Enter Letters	22
Messages Memory	21
Read	25
Send	25
Setting the Phone for Text Messaging	22
SIM Card Memory	21
Store	24
Write	22
Tone Signals	13
touch tones	13
Turning Off the Phone	7

Turning On the Phone	7
Two Line Service	54
Selecting a Line	54

## **U**

Unanswered Calls	11
------------------	----

## **V**

Voice Mail	52
To Turn Off the Voice Mail	53

Second edition (April, 1998)

This user's guide is published by **Ericsson Mobile Communications AB**, without any warranty. Improvements and changes to this user's guide due to typographical errors, inaccuracies of current information, or improvements to programs and/or equipment, may be made by **Ericsson Mobile Communications AB** at any time and without notice. Such changes will, however, be incorporated into new editions of this manual.

All rights reserved.

© **Ericsson Mobile Communications AB**, 1998.

Publication number: **EN/LZT 126 1396 R2A**

Printed in Sweden.

The **CE** symbol on our products signifies that they have been certified according to the EMC directive 89/336/EEC, the Telecommunications directive 91/263/EEC, and the Low Voltage directive 73/23/EEC when applicable. The products fulfil the requirements according to the following standards:

**Cellular Phones and Accessories in Combination:**

- ETS 300 342-1 EMC for European digital cellular telecommunications.

**Accessories Without Direct Connection to a Cellular Phone:**

- EN 50081 Electromagnetic compatibility, Generic Emission Standard
- EN 50082 Electromagnetic compatibility, Generic Immunity Standard.



CLASS 1 LED PRODUCT