

Panasonic

Telephone Conference System

Model No. **KX-TS700E-B**

Pulse-or-tone dialling capability

Operating Instructions

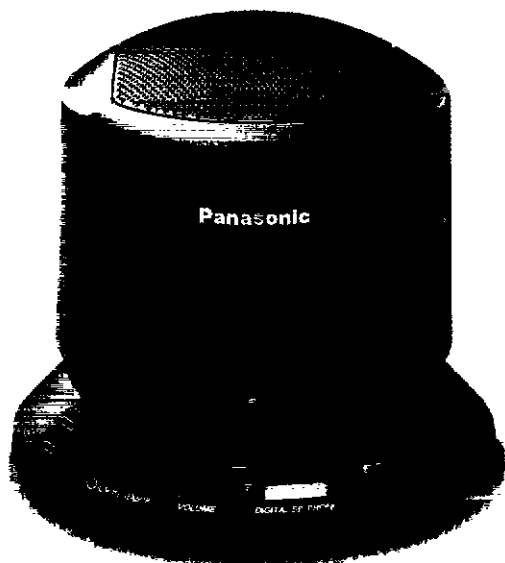

PLEASE READ BEFORE USE AND SAVE.

Advanced Operator

User Manual

Important Information

APPROVED for connection to telecommunication systems specified in the instructions for use subject to the conditions set out in them.

504191

Do not connect the AC adaptor to any AC outlet other than the standard AC 220–240 V, 50 Hz.

- Outlet voltage DC 13.5 V, 400 mA
- The apparatus is approved for use with the KX-TCA6E power supply.
- **CAUTION:** Do not remove cover. Live parts inside.

This apparatus has been approved for the use of the following facilities:

- 1) Storage of telephone numbers for retrieval by a predetermined code
- 2) Last number redial
- 3) Simple telephone facility
- 4) PBX earth register recall
PBX timed break register recall
- 5) MF signalling
- 6) LD signalling
- 7) Loudspeaking
- 8) Hold
- 9) Mute

Any other usage will invalidate the approval of the apparatus if as a result, it then ceases to conform to the standards against which approval was granted.

Ringer Equivalence Number (REN):

This relates to the performance of the apparatus when used in combination with other items of apparatus. It enables the calculation of the maximum number of items of apparatus that may be connected simultaneously to the line by summing the REN values of each item. A BT supplied instrument has a REN value of 1 unless otherwise marked. A maximum REN value of 4 should not be exceeded. The REN value of this apparatus is 1.

Method of connection

This is connected to the exchange line or PABX/PMBX (Private Automatic/Manual Branch Exchange) extension by the new standard British Telecom plug and socket. Arrangements for provision of this type of termination can be made through the nearest British Telecom Sales Office. The apparatus may be connected to the following types of installation. The apparatus has been approved for use under the following conditions:

- a) This apparatus may be used on telecommunication systems employing LD and MF signalling. It is suitable for connection to a direct exchange line on the PSTN (Public Switched Telephone Network) or via a compatible PBX (Private Branch Exchange).
(Contact the supplier for an up to date list of compatible PBX's.)

b) This apparatus is not suitable as an extension to a payphone or for use on a party line with shared service.

999 or 112 can be dialled on the apparatus for the purposes of making outgoing calls to the BT Emergency (999 or 112) Service.

Although this equipment can use either loop disconnect or DTMF signalling, only the performance of the DTMF signalling is subject to regulatory requirements for correct operation. It is therefore strongly recommended that the equipment is set to use DTMF signalling for access to public or private emergency services. DTMF signalling also provides faster call set up.

Any cases of difficulty should be referred in the first instance to the supplier of the apparatus.

NOTE:

If you experience any problems with the normal use of your apparatus, you should unplug it from the telephone outlet and connect a known working telephone in its place. If the known working telephone still gives problems, then call British Telecom Engineers. If it operates properly, then the problem is likely to be a fault in your apparatus. In this case, contact your supplier for advice. British Telecom will charge you if they attend a service call that is not due to apparatus supplied by them.



73/23/EEC
89/336/EEC
92/31/EEC
93/68/EEC

Before Initial Use

Thank you for purchasing the Panasonic telephone conference system.

For your future reference

Serial No. _____ Date of purchase _____
(found on the bottom of the unit)

Name and address of dealer _____

Included with this unit

Remote Control (p. 8)

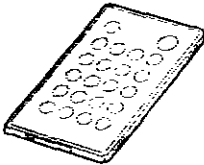

one

Lithium Battery (CR2025) (p. 9)



one

AC Adaptor (p. 10)

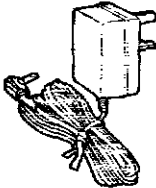

one

Telephone Line Cord (p. 10)



one

Connection Cord (p. 12)

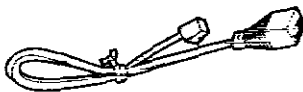

one

About Your KX-TS700E-B

Location

For best performance, the recommended unit location is:



To avoid losing the remote control

Insert the remote control into its compartment and press until it locks into place.

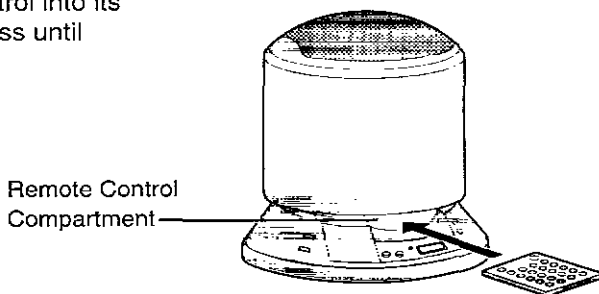

To remove the remote control

Press the remote control to release it from the compartment.

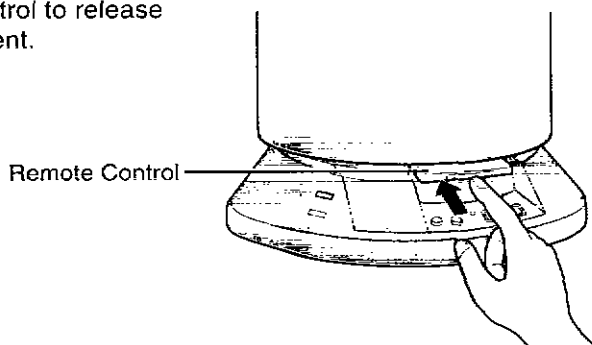

Contents

Preparation

Location of Controls	7
Setting Up	9
Installing the Battery in the Remote Control	9
Connection	10
Adding Another Phone	12
Selector Settings	13

Basic Operation

Remote Control Range	14
Making Calls	15
Answering Calls	17
Automatic Dialling	18
Storing Phone Numbers in Memory	18
Dialling a Stored Number	19

Advanced Operation

Special Features	20
Temporary Tone Dialling (For Rotary Service Users)	20
If Your Unit is Connected to a PBX	20
Muting Your Conversation	20
Using the Recall Feature	21

Useful Information

Before Requesting Help	22
Safety Instructions	24

Location of Controls



OPERATION

Unit

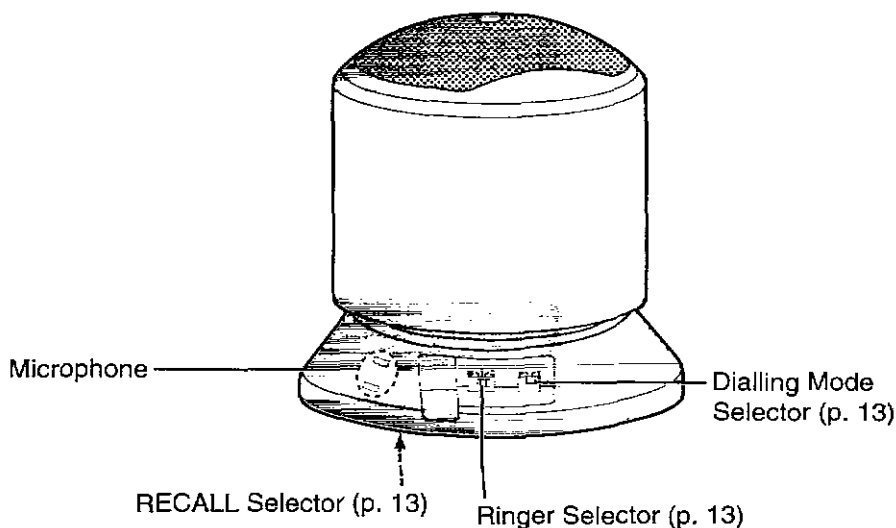
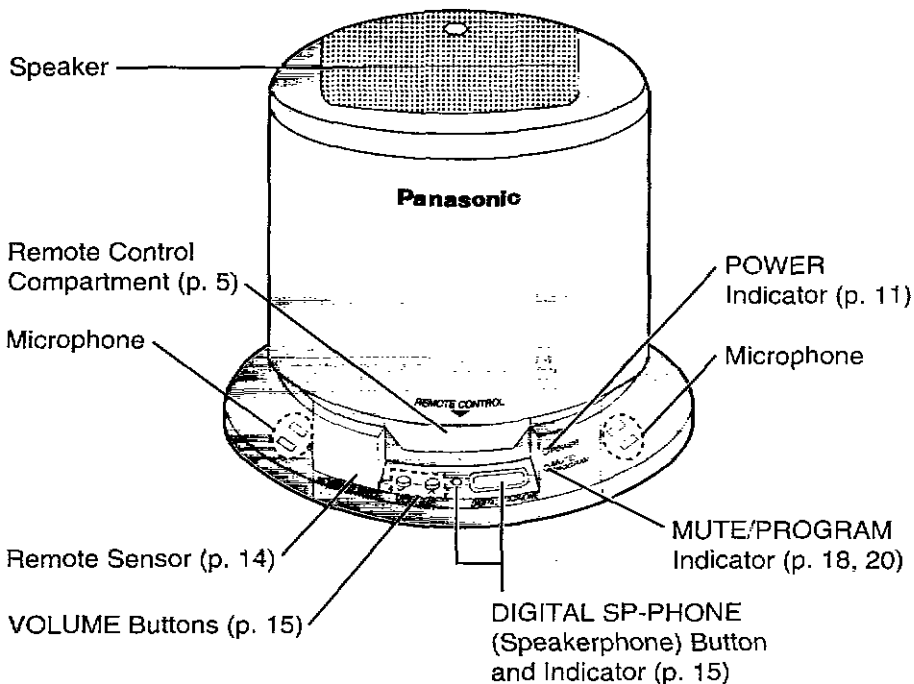

➔ Location of Controls

Remote Control

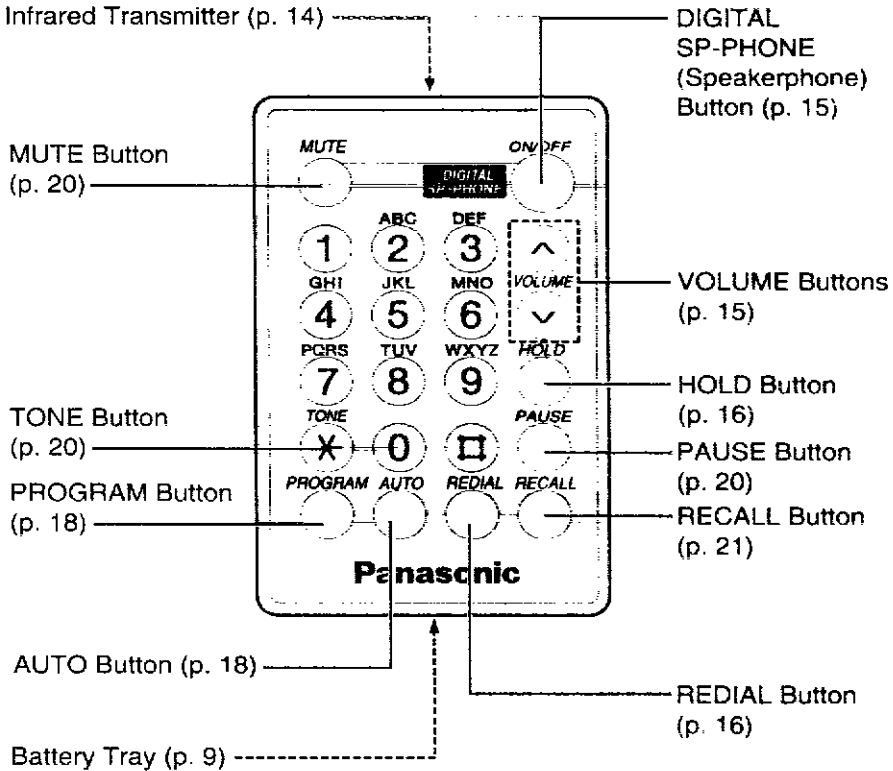

- Do not press the remote control buttons with a pointed object, such as a pen, etc.

Setting Up



Installing the Battery in the Remote Control

- 1 While pressing down notch (A), pull out the battery tray by inserting your fingernail in notch (B).

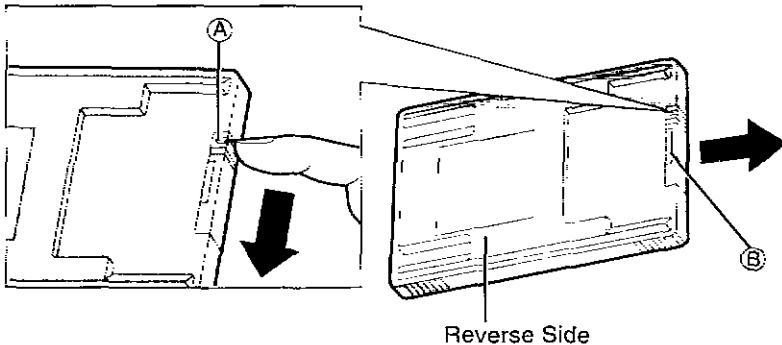

- 2 Install the battery with the plus side up, then insert the tray until it locks into place.

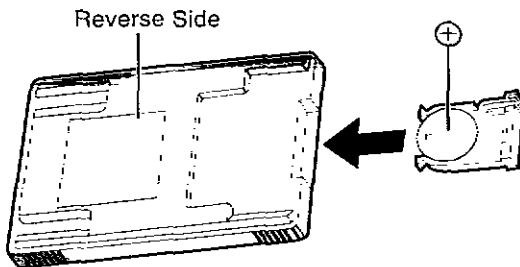

- Please refer to page 25 for correct battery usage.
- Install the battery properly.
- Keep the battery away from children.

Battery Replacement:

- Replace the battery with a **Panasonic CR2025 lithium battery only**. Using another battery may raise the risk of fire or explosion.
- The battery life is about a year when a new Panasonic battery is used at room temperature. (This varies depending on usage and ambient temperature.)
- If the remote control only works when in close vicinity to the unit's remote sensor, replace the battery.

➔ Setting Up

Connection

- 1 Plug in the AC adaptor cord and the telephone line cord to the bottom of the unit.

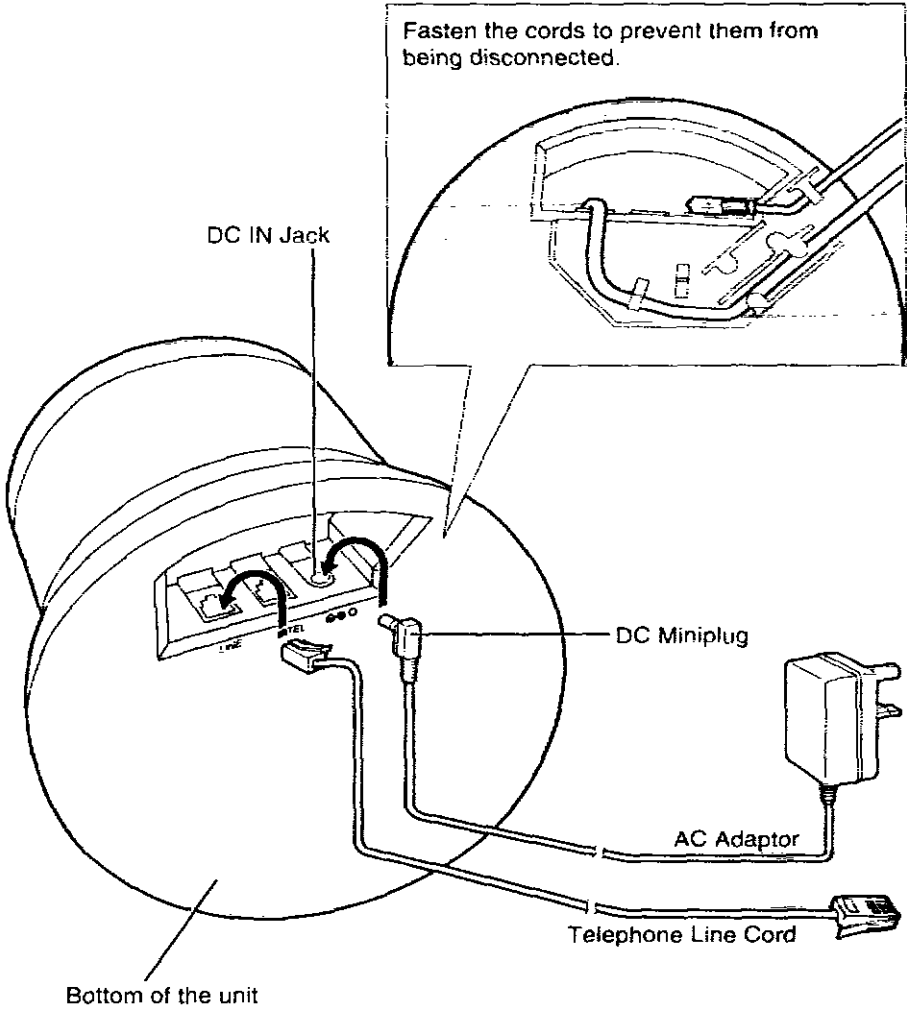



2 Connect the cords as shown.

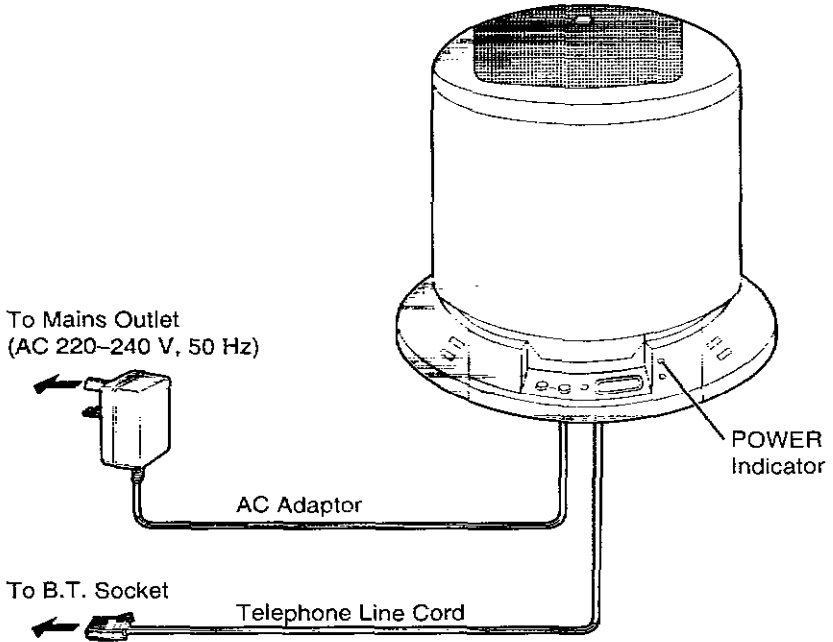

- USE ONLY Panasonic AC ADAPTOR KX-TCA6E.
- The AC adaptor must remain connected at all times.
(It may feel warm during use. This is normal.)
- The POWER indicator lights while the AC adaptor is connected.
- If you connect a reserve telephone on the same line, see page 12.
- This product can be used with a PBX that can support an analog port.
Please contact your PBX dealer for more information.

CONNECTION OF POWER SUPPLY

This apparatus is intended for use when powered by the KX-TCA6E. Using other power supplies will invalidate any approval given to this apparatus.

➔ Setting Up

Adding Another Phone

If the remote control is misplaced or cannot be used, you can connect a standard telephone, using the connection cord, to dial a number. Once the call is connected, turn on the unit's speakerphone. Then hang up the standard telephone.

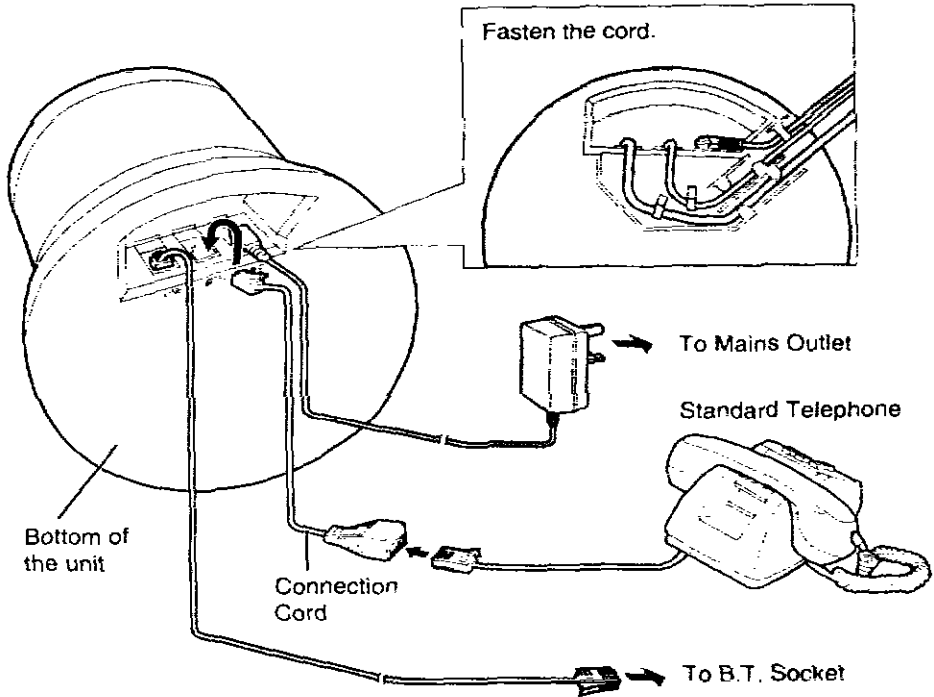

- During a power failure, the unit will not function. Use the standard telephone.

Selector Settings

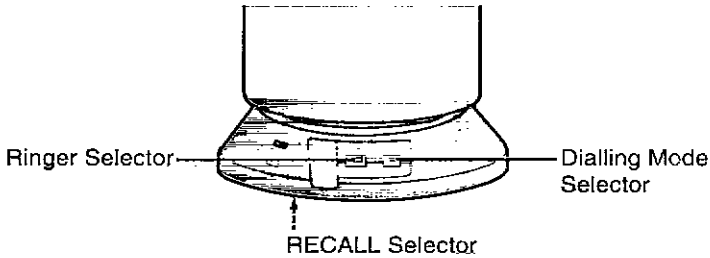

Ringer Selector

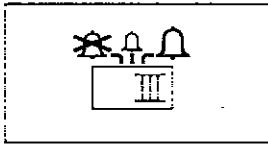

Select the ringer volume of the unit. Set to HIGH (Ω) or LOW (⊔). When set to OFF (⊗), the unit will not ring.

Dialling Mode Selector

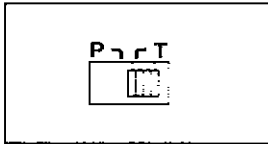

Set to TONE (T) when your telephone line has touch tone service. If rotary service is used, set to PULSE (P).

You can determine which type of local BT exchange you are connected to using the following procedure.

1. Ensure that the dialling mode selector is set to TONE (T).
2. Press **DIGITAL SP-PHONE**, then identify the dial tone.
3. Dial a number you are familiar with.
4. If the call is successful, you are connected to a tone exchange. Therefore, leave the dialling mode selector to TONE (T).
5. If the call is not successful, you are connected to a pulse exchange. Therefore, switch the dialling mode selector back to PULSE (P).

RECALL Selector

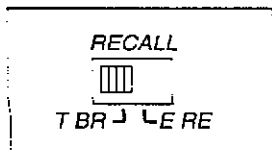

Set to T BR if the unit is connected directly to an exchange line. If the unit is connected via a PBX (switchboard), then you may need to switch to E RE. Check with your switchboard manager or supplier for the proper setting.

Remote Control Range

When using the remote control, point the infrared transmitter towards the remote sensor within the unit's maximum operating range.

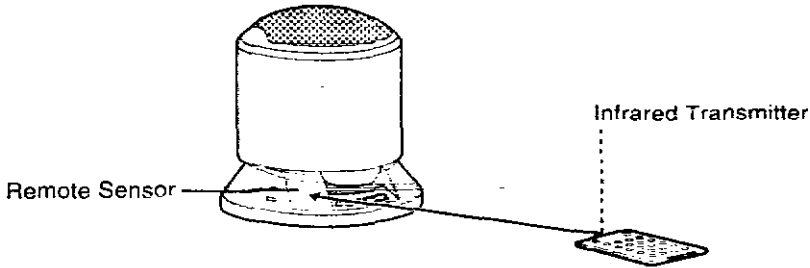

The maximum operating area is:

Range

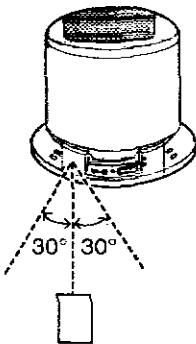

Distance

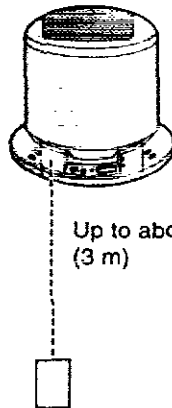

- The operating range may vary depending on the room lighting (incandescent, fluorescent, etc.) or brightness.

Making Calls



1 Press **DIGITAL SP-PHONE** on the remote control.

- The DIGITAL SP-PHONE indicator on the unit lights.

2 Dial a telephone number.

3 To hang up, press **DIGITAL SP-PHONE**.

- The indicator light goes out.

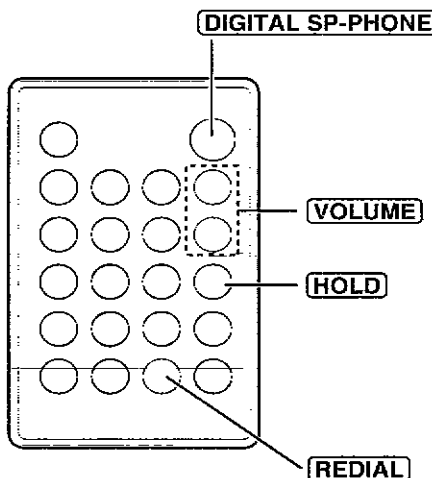

Basic Operation

- You can also use **DIGITAL SP-PHONE** on the unit in steps 1 and 3.

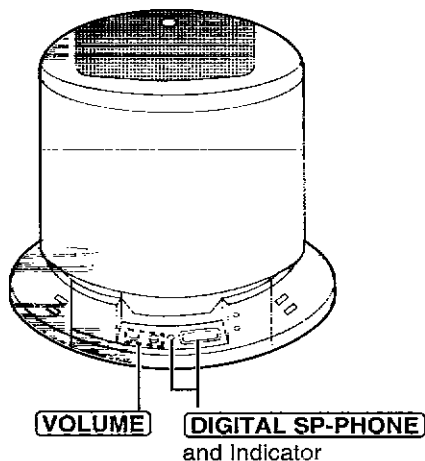

To adjust the speaker volume (12 levels)

To increase, press . To decrease, press .

➔ Making Calls

Digital Speakerphone

For best performance, please note the following:

- Speak alternately with the caller.
- If the other party's voice from the speaker cuts in/out during a conversation, press  to decrease the speaker volume.
- Use the speakerphone in a quiet room.

To redial the last number

Press **DIGITAL SP-PHONE** → **REDIAL**.

To put a call on hold

Press **HOLD**.

- The DIGITAL SP-PHONE indicator on the unit flashes.
- If you put a call on hold for 6 minutes, a warning tone will sound. The call will be disconnected after a total of 10 minutes.

To release the hold

Press **DIGITAL SP-PHONE**.

- If another phone is connected on the same line (p. 12), you can also take the held call on that phone, by lifting its handset.

About the **DIGITAL SP-PHONE** button on the unit

The **DIGITAL SP-PHONE** button on the unit uses non-radioactive luminescent material which can absorb the light energy of sunlight or lamps (incandescent, fluorescent, halogen, etc.) and release this absorbed light for darkened room operations.

Notice:

- As the absorbed energy in the **DIGITAL SP-PHONE** button decreases, the button brightness will fade naturally.
- Button brightness and duration depends on the amount of room lighting and exposure time.

Answering Calls

1 Press **DIGITAL SP-PHONE** on the remote control.

2 To hang up, press **DIGITAL SP-PHONE**.

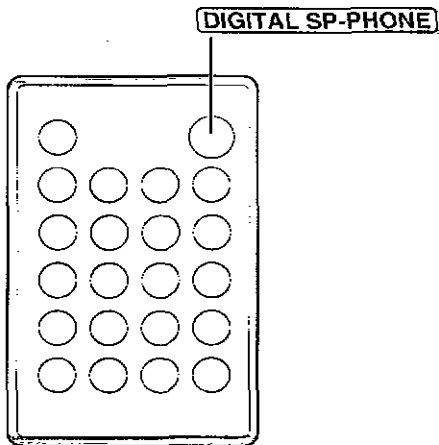

• You can also answer a call by pressing **DIGITAL SP-PHONE** on the unit.

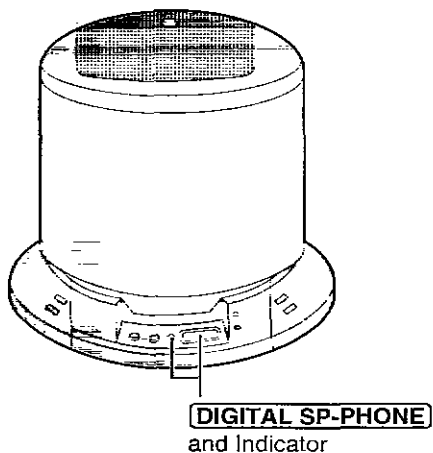

Automatic Dialling

Storing Phone Numbers in Memory

You can store up to 10 phone numbers in the unit using the remote control. The dialling buttons (0 to 9) function as memory stations.

The **DIGITAL SP-PHONE** indicator light must be off. Point the Infrared transmitter towards the remote sensor while storing.

- 1 Press **PROGRAM**.
 - The MUTE/PROGRAM indicator on the unit flashes.

- 2 Enter a phone number up to 16 digits.
 - If you misdial, press **PROGRAM** to end storing, then restart from step 1.

- 3 Press **AUTO**.

- 4 Press a memory station number (0 to 9).
 - A confirmation tone sounds. (See the next page.)
 - To store other numbers, repeat steps 1 through 4.

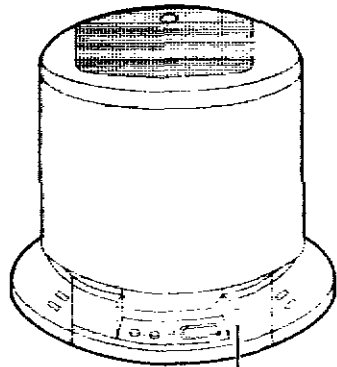
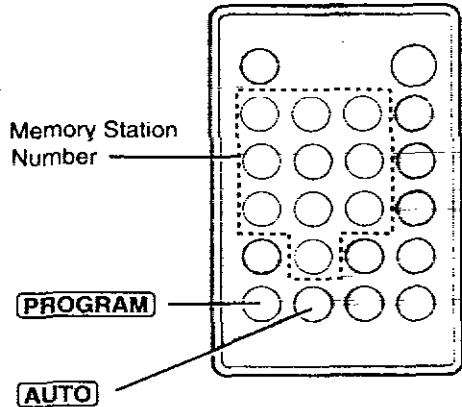

- If the AC adaptor is disconnected for more than 3 days, the stored numbers should be confirmed again before dialling.

What the confirmation tone means

1 beep: A new number has been stored.

2 beeps: The number is the same as a previously stored one.

To erase a stored number

Press **PROGRAM** → **AUTO** → the memory station number (0 to 9) for the phone number to be erased.

Memory sticker

Use the included memory sticker as a name or phone number index for automatic dialling. Attach the sticker to the unit or in a convenient place.

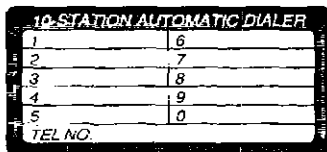

Dialling a Stored Number

1 Press **DIGITAL SP-PHONE**.

2 Press **AUTO**.

3 Press a memory station number (0 to 9).

- The stored number is dialled.

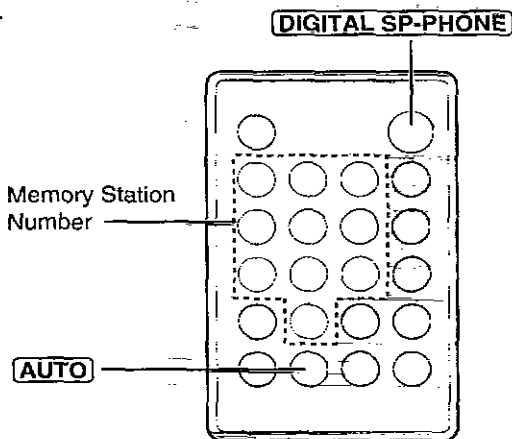

Special Features

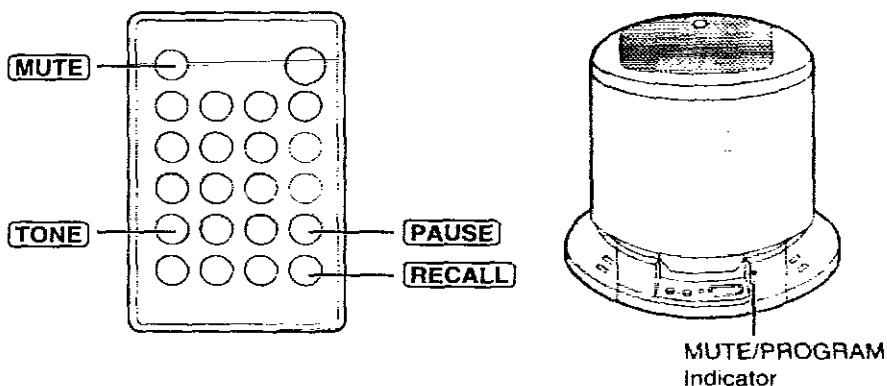

Temporary Tone Dialling (For Rotary Service Users)

Press **TONE** before entering access numbers which require tone dialling.

- The dialling mode changes to tone. You can enter numbers to access answering systems, electronic banking services, etc. When you hang up, the mode returns to pulse.

If Your Unit is Connected to a PBX

We recommend you press **PAUSE** between the access number for an outside line and the phone number.

- Pressing **PAUSE** once creates a 3.5 second pause. This prevents misdialling when you redial or dial a stored number. (**PAUSE** counts as one digit.)

Muting Your Conversation

Press **MUTE** while talking. (The MUTE/PROGRAM indicator lights.)

- The other party cannot hear your voice but you can hear theirs.
- To resume the conversation, press **MUTE** again.

Using the Recall Feature

The RECALL button is used to access special telephone services (optional) such as call waiting. Contact your telephone company business office for details.

Example: British Telecom call waiting

1. Ensure that you have set the RECALL selector to T BR (p. 13).

2. When a call waiting tone is heard during a conversation

a) To hold the existing call and accept the waiting call

Press **RECALL**.

- Each time you press **RECALL**, you can switch between the first and second call.

b) To accept the waiting call and clear from the existing call

Press **DIGITAL SP-PHONE**. When the unit rings, press

DIGITAL SP-PHONE to answer the new call.

c) To reject the waiting call

Allow the call waiting to time out. This will take about 40 seconds.

If your unit is connected to a PBX, pressing **RECALL** allows you to access some features of your host PBX such as transferring an extension call.

Before Requesting Help

Problem	Remedy
The unit does not work.	<ul style="list-style-type: none">• Check the settings (p. 9-13).
The unit stops working during operation.	<ul style="list-style-type: none">• Unplug the AC adaptor to reset. Plug in, then try again.• Re-insert the remote control battery and try again.
The unit does not ring.	<ul style="list-style-type: none">• The RINGER selector is set to OFF (⊗). Set to HIGH (Δ) or LOW (Δ).
Short silences, echoes, or speech cuts occur during conversations.	<ul style="list-style-type: none">• Do not move the unit while it is in use.• Keep your hands away from the unit during calls.• Keep files, cups, coffee pots, etc., away from the unit.• Speak alternately with the caller.
While storing a phone number, the unit starts to ring.	<ul style="list-style-type: none">• To answer the call, press DIGITAL SP-PHONE. The program will be cancelled. Store the number again.
You cannot store a phone number in memory.	<ul style="list-style-type: none">• You cannot store a number during a conversation.• Do not pause for over 30 seconds while programming.• Point the infrared transmitter towards the remote sensor while storing.

Problem

Remedy

The remote control does not work.

- Move closer or in range of the unit (p. 14).
- Move the unit's remote sensor away from strong light, such as direct sunlight.
- The battery power is low. Replace with a new one (p. 9).
- Install the battery correctly (p. 9).
- Clean the remote sensor and the infrared transmitter with a soft, dry cloth.

The POWER indicator light never goes out while the AC adaptor is connected.

- This is normal.

Safety Instructions

Take special care to follow the safety suggestions listed below.

Safety

- 1) Power Source: The unit should be connected to a power supply only of the type described in the operating instructions or as marked on the unit.
- 2) Nonuse Periods: When left unused for a long period of time, the unit should be unplugged from the household AC outlet.

Installations

Environment

- 1) Water and Moisture: Do not use this unit near water—for example, near a bathtub, washbowl, sink, etc. Damp basements should also be avoided.
- 2) Heat: The unit should be kept away from heat sources such as radiators, cookers, etc. It also should not be placed in rooms where the temperature is less than 5°C (41°F) or greater than 40°C (104°F).

Placement

- 1) Stacking: Do not place heavy objects on top of this unit.
- 2) Foreign Material: Care should be taken so that objects do not fall onto and liquids are not spilled into the unit. Do not subject this unit to excessive smoke, dust, mechanical vibration, or shock.
- 3) Surface: Place the unit on a flat surface.
- 4) Magnetism: The unit should be kept away from equipment or devices that generate a strong magnetic field.

WARNING:

TO PREVENT THE RISK OF FIRE OR ELECTRICAL SHOCK, DO NOT EXPOSE THIS PRODUCT TO RAIN OR ANY TYPE OF MOISTURE.

Battery caution:

To reduce the risk of fire or injury to persons, read and follow these instructions.

1. Use only the battery(ies) specified.
2. Do not dispose of the battery(ies) in a fire. It (they) may explode.
3. Do not open or mutilate the battery(ies). Released electrolyte is corrosive and may cause burns or injury to the eyes or skin. The electrolyte may be toxic if swallowed.
4. Exercise care in handling the battery(ies) in order not to short the battery(ies) to conductive materials such as rings, bracelets, and keys. The battery(ies) and/or conductor may overheat and cause burns.
5. Do not recharge the battery(ies) provided with or identified for use with this product. The battery(ies) may leak corrosive electrolyte or explode.
6. Do not attempt to rejuvenate the battery(ies) provided with or identified for use with this product by heating. Sudden release of battery electrolyte may occur causing burns or irritation to the eyes or skin.
7. Remove the battery(ies) from this product if the product will not be used for a long period of time (several months or more). During this time the battery(ies) could leak in the product.
8. Discard the "dead" battery(ies) as soon as possible. The "dead" battery(ies) may leak in the product.
9. Do not store this product, or the battery(ies) provided with or identified for use with this product, in high temperature areas. Batteries that are stored in a freezer or refrigerator for the purpose of extending shelf life should be protected from condensation during storage and defrosting. Batteries should be stabilized at room temperature prior to use after cold storage.
10. Danger of explosion if battery(ies) is/are incorrectly replaced. Replace only with the same or equivalent type recommended by the manufacturer. Dispose of used battery(ies) according to the manufacturer's instructions.

GUARANTEE

CONDITIONS OF GUARANTEE

This guarantee is in addition to and does not in any way affect any statutory or other rights of consumer purchasers. If within the applicable guarantee period, the appliance proves to be defective by reason of faulty design, workmanship or materials, we undertake subject to the following conditions to have the defective appliance (or any part or parts thereof) repaired or replaced free of charge.

1. The appliance shall have been purchased and used solely within the UK and in accordance with standard operating instructions and the technical and/or Safety Standards required in the UK.
2. The appliance should be returned together with this guarantee and proof of date of purchase promptly on being found defective at the purchaser's risk and expense to the authorized dealer from whom the appliance was purchased or to the nearest authorized dealer. All enquiries must be through such dealers.
3. This guarantee shall not apply to damage caused through fire, accident, lightning, misuse, wear and tear, neglect, incorrect adjustment or repair, to damage caused through installation, adaption, modification or use in an improper manner or inconsistent with the technical and/or safety standards required in the country where this appliance is used, or to damage occurred during transit to or from the purchaser.
4. If at any time during the guarantee period any part or parts of the appliance are replaced with a part or parts not supplied or approved by us or of an objective quality safe and suitable for the appliance, or the appliance has been dismantled or repaired by any person not authorized by us, we shall have the right to terminate this guarantee in whole or in part immediately without further notice.
5. The purchaser's sole and exclusive remedy under this guarantee against us is for the repair or replacement of the appliance or any defective part or parts and no other remedy, including, but not limited to, incidental or consequential damage or loss of whatsoever nature shall be available to the purchaser.
6. This guarantee shall not apply to cassette tapes, batteries and any other items of limited natural life.
7. Our decision on all matters relating to complaints shall be final. Any appliance or defective part which has been replaced shall become our property.
8. The guarantee period applicable to this product shall be 12 months.

Please keep these Operating Instructions with your receipt.

Panasonic Business Systems U.K.

Receipt No. _____

Date of Purchase _____

Model No. **KX-TS700E-B** _____

Serial No. _____