

Panasonic

AUTOMATIC TELEPHONE
ANSWERING SYSTEM

Easa-Phone

MODEL NO. **KX-T5006E**

Operating Instructions



Please read before use.

AUTO-LOGIC

Important information

APPROVED for connection to telecommunication systems specified in the instructions for use subject to the conditions set out in them.

S/1010/3/R/503136

Do not connect the AC adaptor to any AC outlet other than the standard AC 240 V, 50 Hz.

- Outlet voltage DC 13.5 V, 400 mA
- The apparatus is approved for use with the KX-A11BE or KX-A11DBE power supply.
- **CAUTION:** Do not remove cover. Live parts inside.

Ringier Equivalence Number (REN):

This relates to the performance of the apparatus when used in combination with other items of apparatus. It enables the calculation of the maximum number of items of apparatus that may be connected simultaneously to the line by summing the REN values of each item. A BT supplied instrument has a REN value of 1 unless otherwise marked.

A maximum REN value of 4 should not be exceeded. The REN value of this apparatus is 1.

Method of connection

This is connected to the exchange line or PABX/PMBX (Private Automatic/Manual Branch Exchange) extension by the new standard British Telecom plug and socket.

Arrangements for provision of this type of termination can be made through the nearest British Telecom Sales Office. The apparatus may be connected to the following types of installation. The apparatus has been approved for use under the following conditions:

- a) For connection to the public switched telephone network (PSTN) and compatible PBX (Private Branch Exchange), which use LD signalling and MF signalling. (Please consult your supplier for an up to date list of compatible PBX's.)
- b) The apparatus can be used on extension sockets connected to a direct exchange line (D.E.L.).
- c) This apparatus is suitable for connection to the telecommunication system directly or via compatible private branch exchange as an extension. The supplier of the apparatus should be consulted for an up to date list of PBX's with which the apparatus is compatible.

- d) This apparatus must not be connected in the following manner:
- 1) As an extension to a pay phone
 - 2) As a party line with shared service

It cannot be guaranteed that the apparatus will operate under all possible conditions of connection to compatible PBX's.

- This apparatus is suitable for connection to a PBX with or without initial proceed indication.
- This apparatus is suitable for connection to a PBX with or without secondary proceed indication.

This apparatus is suitable for connection to a Relevant Branch System that is connected to one or more PSTN line, as defined in BS 6789 Section 6.1 Clause 2.4.

This apparatus has been approved for the use of the following facilities:

- 1) 3-step caller's recording time selector:
VOX/1 MIN/GREETING ONLY
- 2) 3-step ring selector:
2/6/AUTO
- 3) Answering and recording system
- 4) Auto disconnect
- 5) DTMF tone remote control system
- 6) Monitoring a telephone call
- 7) Series Connection

Any other usage will invalidate the approval of the apparatus if as a result, it then ceases to conform to the standards against which approval was granted.

A voltage drop of 0.3 volts at 40 mA will be introduced between the telephone socket and the PSTN.

Any cases of difficulty should be referred in the first instance to the supplier of the apparatus.

NOTE:

If you experience any problems with the normal use of your apparatus, you should unplug it from the telephone outlet and connect a known working telephone in its place. If the known working telephone still gives problems, then call British Telecom Engineers. If it operates properly, then the problem is likely to be a fault in your apparatus. In this case, contact your supplier for advice. British Telecom will charge you if they attend a service call that is not due to apparatus supplied by them.

Included with this unit _____

AC Adaptor one
(p. 9)

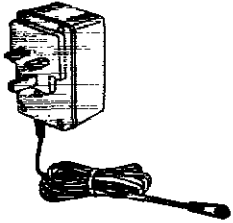

Greeting Message Tape
(MC-10) one
(p. 8)

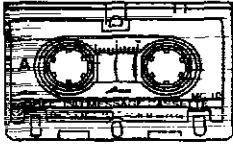

Incoming Message Tape
(MC-30) one
(p. 8)

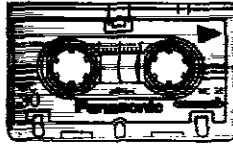

Contents ---

Important information	2
Included with this unit	4
Location of controls	6
Setting up the unit	8
Inserting the cassette tapes	8
Connection	9
Setting the selector switches	10
Recording a greeting message	12
Checking the greeting message	14
Adjusting the VOLUME control	14
Automatic answering operation	15
Setting the unit to answer calls	15
Listening to the recorded messages	16
Listening to new messages only	17
Listening to all the recorded messages	17
Saving some old messages	19
Resetting the incoming message tape	20
Erasing the recorded messages	20
Recording your own message	21
Monitoring incoming calls	22
Remote operation from a touch tone phone	23
Setting the remote code number	23
Direct remote operation (Basic)	24
Direct remote operation (Advanced)	26
Troubleshooting guide	31
Maintenance	32
Safety instructions	34

Location of controls

ANSWER ON Button and Indicator (p. 15)

IN USE Indicator (p. 13)

VOLUME Buttons (p. 14)

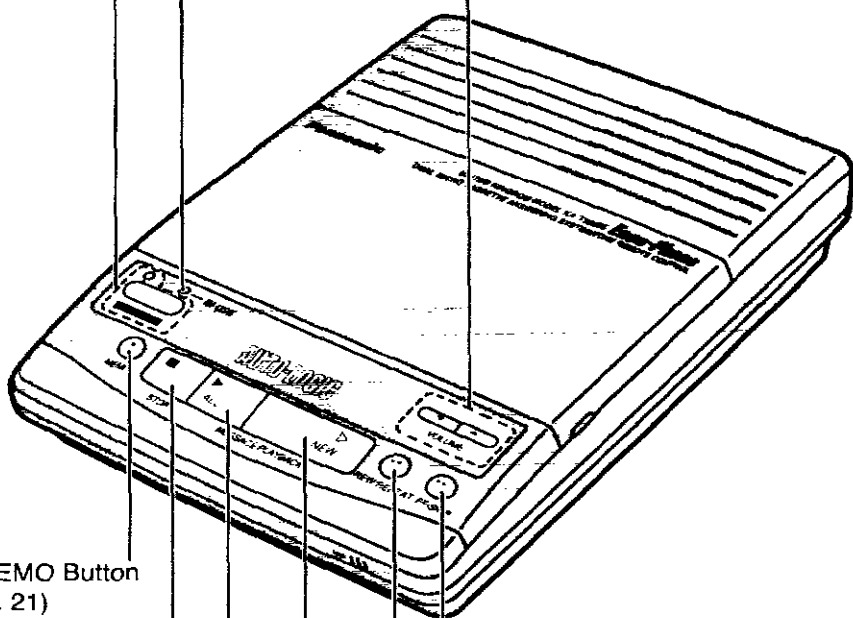

MEMO Button
(p. 21)

STOP Button
(p. 13, 18, 21)

ALL MESSAGE PLAYBACK
Button (p. 17)

FF (Fast Forward)/SKIP Button
(p. 18)

REW (Rewind)/REPEAT Button
(p. 18)

NEW MESSAGE PLAYBACK Button (p. 17)

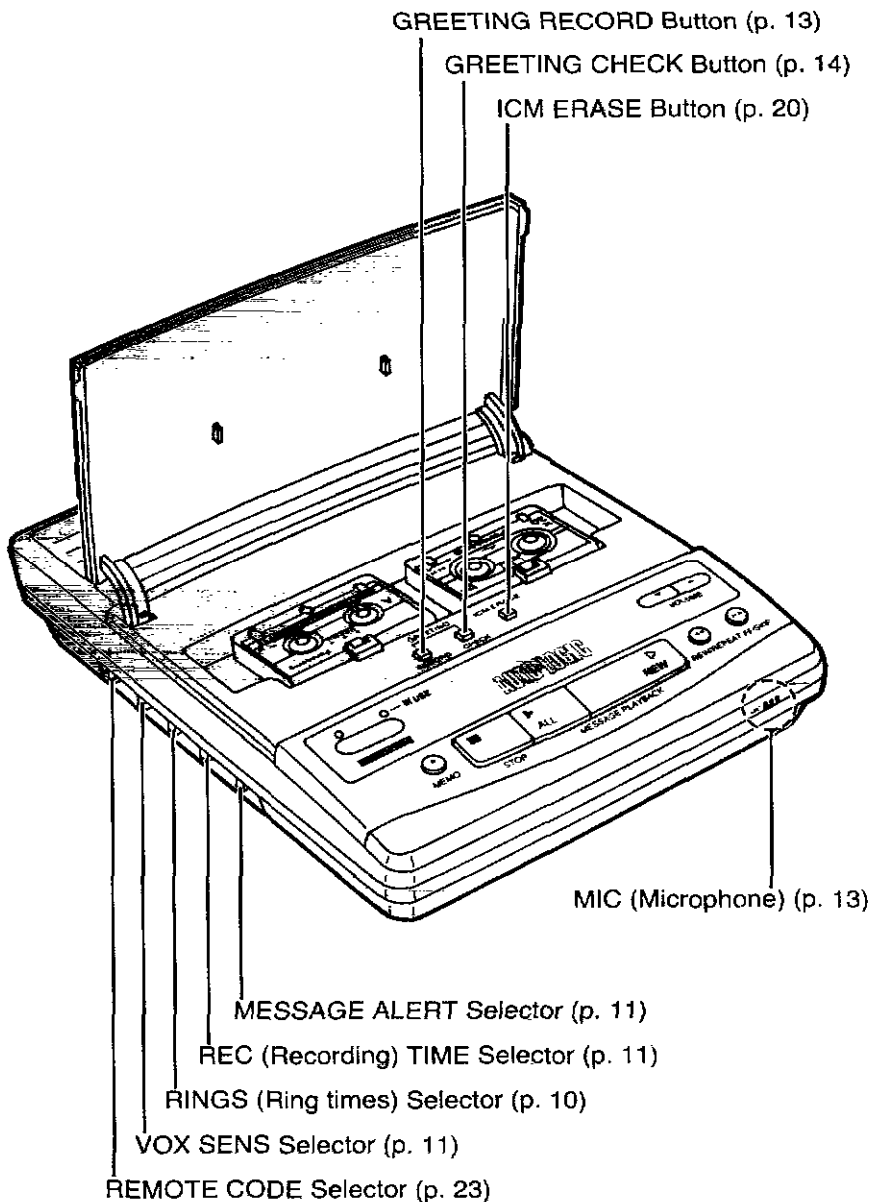

Setting up the unit ---

Inserting the cassette tapes

Remove the stopper from the micro cassette tapes.

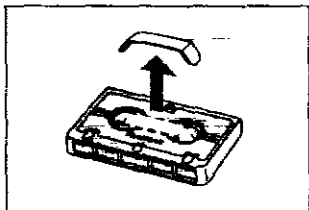

Open the cassette compartment lid.

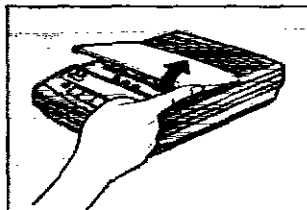

Insert the cassette tapes with the full reel to the left.

Greeting Message Tape (MC-10)



Incoming Message Tape (MC-30)

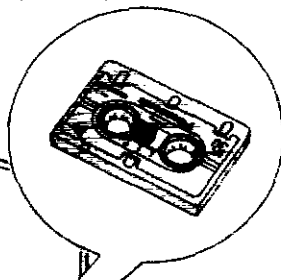

BLUE Label

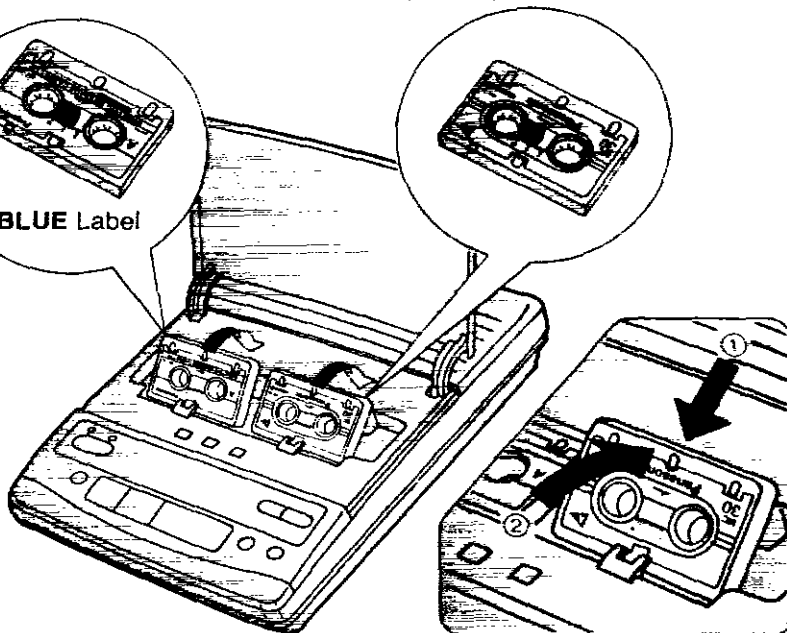

Connection

CONNECTION OF POWER SUPPLY

This apparatus is intended for use when powered by the KX-A11BE or KX-A11DBE. Using other power supplies will invalidate any approval given to this apparatus.

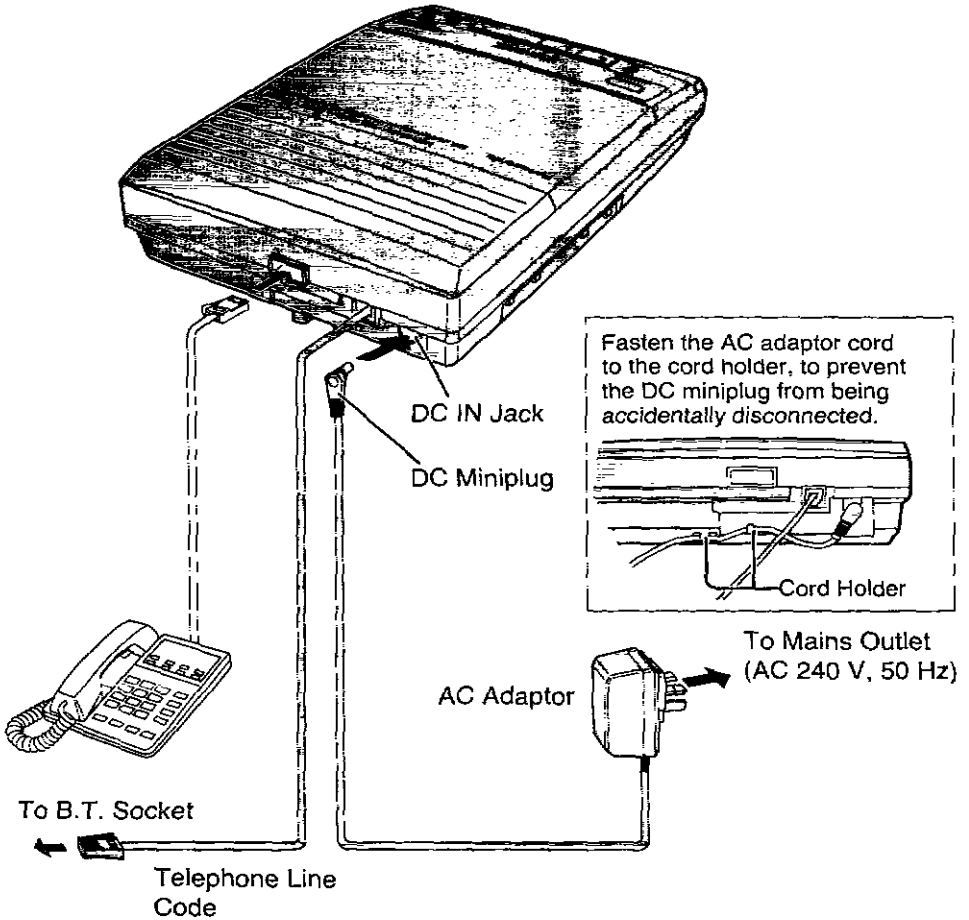

Notes:

- USE ONLY Panasonic AC ADAPTOR KX-A11BE or KX-A11DBE. The adaptor must remain connected at all times.
- The DC IN Jack is at SELV (Safety Extra Low Voltage).
- The line connections are at TNV (Telecommunication Network Voltage).

Setting the selector switches

- REMOTE CODE Selector
- VOX SENS Selector
- RINGS (Ring times) Selector
- REC (Recording) TIME Selector
- MESSAGE ALERT Selector

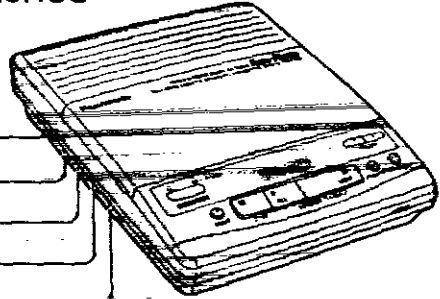

RINGS (Ring times) Selector

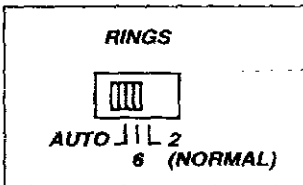

The RINGS selector (answer mode selector) has three positions as follows:

- Position “2” may be referred to as “NORMAL” as it enables the machine to answer incoming calls in a reasonably short time. The machine answers the call on the 2nd ring.
- Position “6” makes the machine answer on the 6th ring.
- Position “AUTO” (also known as “Toll Saver”) can be used so that when you are calling in to your machine to get messages, you will know without being charged for the call if there are any new messages.

“NORMAL” switch position should be generally selected unless you specifically wish to take advantage of the “toll saver facility”.

Callers are generally accustomed to their calls being answered within 10 seconds and most callers abandon the call in under 45 seconds if no reply is obtained. This machine will answer incoming calls in under 10 seconds if required.

Toll saver

When you call the unit from a touch tone telephone, the number of rings before the unit answers informs you if there are any new messages.

- If the unit answers on the 2nd ring: There is at least one new message.
- If the unit answers on the 6th ring: There are no new messages.

Hang up immediately when you hear the 3rd ring. The 3rd ring indicates there are no new messages. This will save you being charged for the call.

REC (Recording) TIME Selector

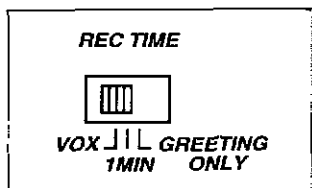

Used to select the caller's recording time.

VOX: Unlimited.

1 MIN: Limited to 1 minute.

GREETING ONLY:

When a call comes in, the unit answers the call, plays the greeting message, then hangs up. The unit will not record any caller's message.

MESSAGE ALERT Selector

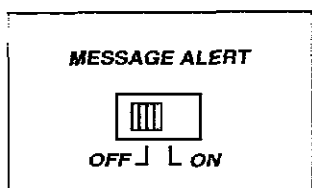

When you come home, you can be informed that new messages have been recorded by the presence of an audible beep.

ON: When new messages have been recorded, a short beep sounds every 10 seconds. The beeping stops after the messages have been played back.

OFF: No beep sounds.

VOX SENS Selector

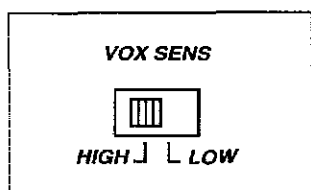

If either the tape continues to run after a caller has replaced his handset or there are long pauses between or after messages, set the selector to the position "LOW". (Normally the switch is preset to the position "HIGH".)

REMOTE CODE Selector

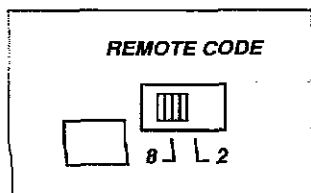

The remote code number is 2-digit. The first digit is factory preset, and the second digit is selectable (2 or 8). See page 23 for details.

Recording a greeting message

The greeting message is an announcement to tell the caller that you are unable to answer the call and asks him/her to leave a message.

The recording time is limited to 2 minutes 45 seconds.

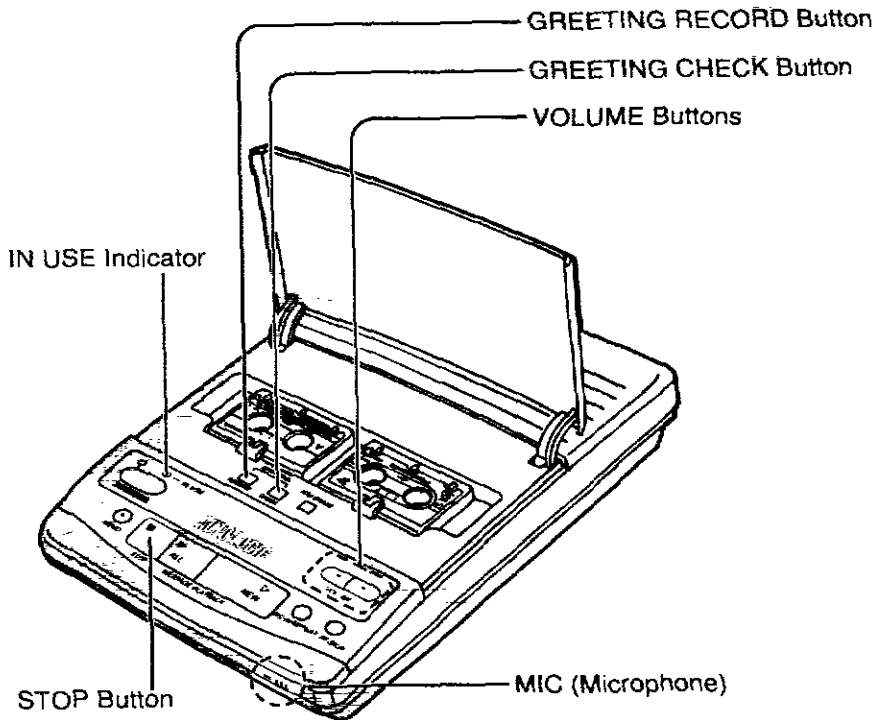

Notes:

- It is helpful to include a statement of your answering telephone number with the exchange name or national code in the greeting message. A greeting message begins within 3 seconds of answering, or paytone ceasing, or of answering ceasing, as appropriate.
- Paytone may be received after answering calls from some types of payphone and may persist for up to 13 seconds. The greeting message should be constructed so as to ensure that a greeting message containing the identity of the called line and, where appropriate, the invitation to record, will be heard by payphone callers after paytone has ceased.

Do not pause for over 5 seconds while recording. If 6 beeps sound while recording, start again from step 1 after resetting the greeting message tape.

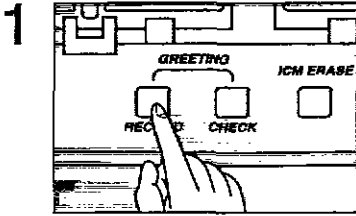

Press the GREETING RECORD button, then release it.

—A long beep sounds.

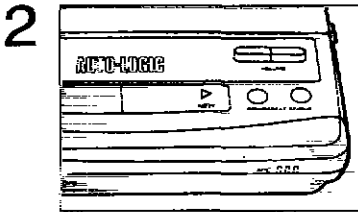

Immediately after the long beep, speak clearly and loudly, 20 cm (8") away from the MIC (microphone).

—The IN USE indicator flashes.

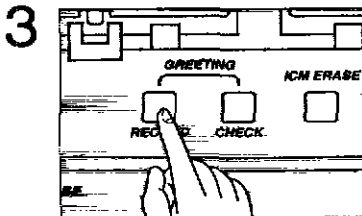

When you finish recording, press the GREETING RECORD or the STOP button.

Checking the greeting message

You can play back and check your recorded greeting message.

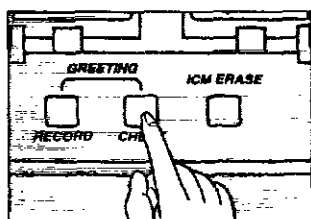

Press the GREETING CHECK button to play back the greeting message.

—Adjust the speaker volume using the VOLUME buttons.

Adjusting the VOLUME control

There are 8 levels of speaker volume, and you can adjust it to your desired level using the VOLUME buttons, 0 (minimum) through 8 (maximum).

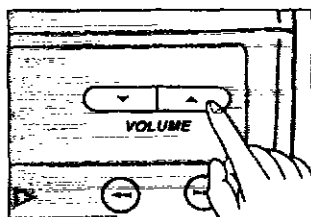

To increase the volume, press ▲.

To decrease the volume, press ▼.

Samples of greeting messages

When the REC TIME selector is in the VOX (unlimited) position:

"Hello, this is (your name and/or number). Sorry, I cannot take your call. Please leave your message after a long beep. If a beep sounds 6 times, your message will not be recorded. Should this happen, please call back tomorrow. Thank you."

When the REC TIME selector is in the 1 MIN position:

"Hello, this is (your name and/or number). Sorry, I cannot take your call. Please leave your message after a long beep. Your recording time is up to 1 minute. If a beep sounds 6 times, your message will not be recorded. Should this happen, please call back tomorrow. Thank you."

When the REC TIME selector is in the GREETING ONLY position:

"Hello, this is (your name and/or number). Sorry, I cannot take your call. If you call back tomorrow, I'll be happy to talk to you. Thank you."

Automatic answering operation

When a call is received, the unit plays back your greeting message, and records the caller's message. After the call is completed, it will be ready for the next call automatically.

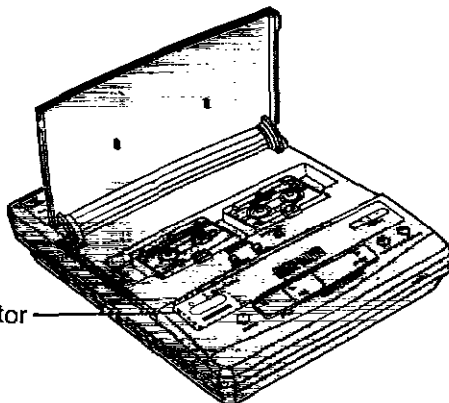

ANSWER ON Button and Indicator

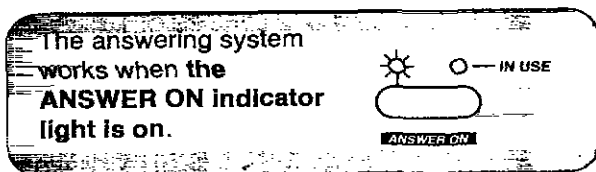

Setting the unit to answer calls

Set the unit as follows to answer a call and record messages.

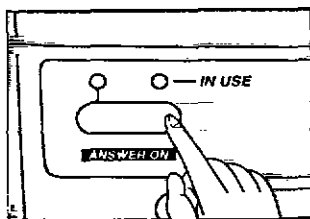

Press the ANSWER ON button to turn the answering system on.

—The ANSWER ON indicator light is on and the unit is ready to receive calls.

To turn the unit off

If you do not want the unit to answer calls, press the ANSWER ON button, and confirm that the ANSWER ON indicator light goes out.

When you turn the unit off, the unit will answer and record an incoming call if rung 20 times (Remote turn on).

Listening to the recorded messages

- When new incoming messages have been recorded;
 - the NEW MESSAGE indicator flashes to show the number of recorded messages up to 15.
 - a short beep sounds every 10 seconds if the MESSAGE ALERT selector is set to the ON position.

VOLUME Buttons
To increase the volume, press ▲.
To decrease the volume, press ▼.

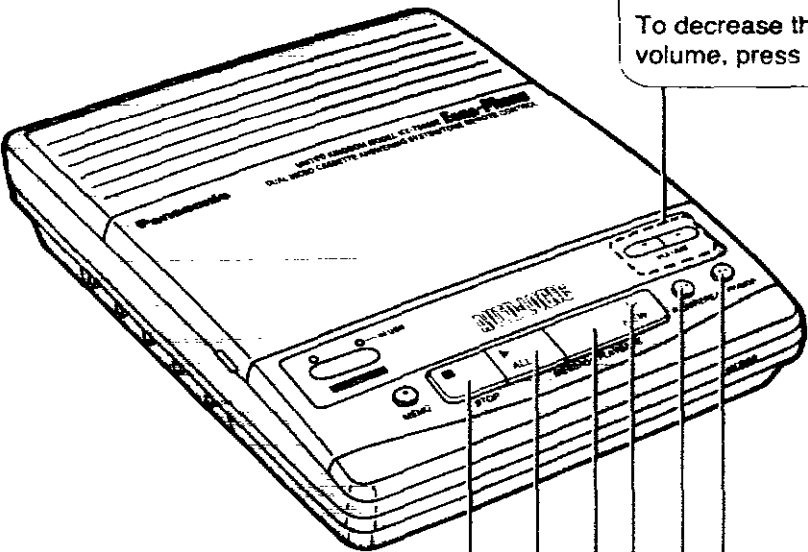

STOP Button

ALL MESSAGE PLAYBACK Button

NEW MESSAGE PLAYBACK Button and Indicator

REW/REPEAT Button

FF/SKIP Button

Listening to new messages only

Only new messages are played back. Messages once reviewed will not be played back.

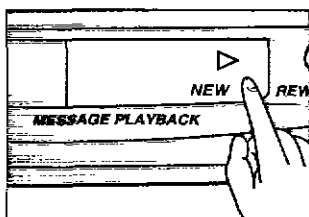

Press the **NEW MESSAGE PLAYBACK** button.

—The unit plays back new messages.

Listening to all the recorded messages

All the recorded messages—including those previously reviewed or saved—will be played back from the beginning of the tape.

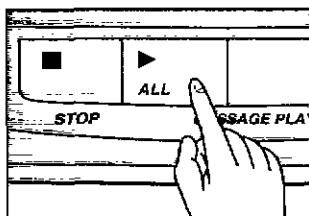

Press the **ALL MESSAGE PLAYBACK** button.

—The unit plays back all the recorded messages.

AUTO-LOGIC

By pressing a **MESSAGE PLAYBACK** button, the unit automatically;

- rewinds the tape and plays back the messages
- beeps once after each message
- stops the tape and beeps 3 times after the last message has been played
- prepares to record new messages after the old messages

The following functions are available during message playback.

To repeat the message during playback

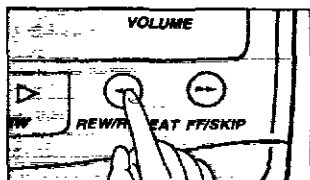

Press the REW/REPEAT button.

—The unit rewinds the tape to the beginning of the message and starts playback again.

Note:

—If you press the REW/REPEAT button within 5 seconds of playing back the message, the unit will play back messages from the one before.

To skip the message during playback

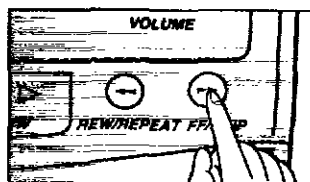

Press the FF/SKIP button.

—The unit forwards the tape to the beginning of the next message and starts playback again.

To stop the operation

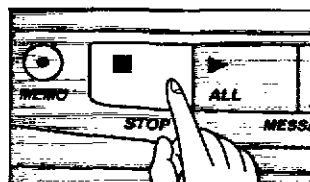

Press the STOP button to stop playing back, or other operation.

In case your unit is not in playback operation.

When you press the REW/REPEAT button, the unit rewinds the tape to the beginning automatically.

When you press the FF/SKIP button, the unit forwards the tape to the end of the last message automatically.

Saving some old messages

If you do not want to clear away some old messages previously recorded, you can save them.

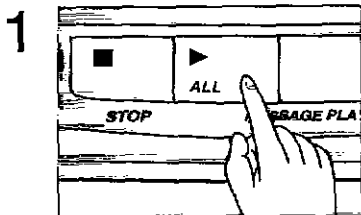

Press the ALL MESSAGE PLAYBACK button to play back the messages.

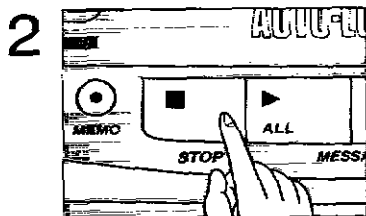

Press the STOP button at the end of the message you want to save.

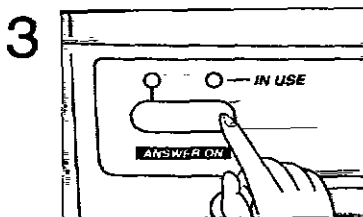

Press the ANSWER ON button to turn the answering system on.

- The ANSWER ON indicator light is on.
- The new messages will be recorded after the message(s) you have saved.

Resetting the incoming message tape

To record new messages from the beginning of the incoming message tape, rewind the incoming message tape.

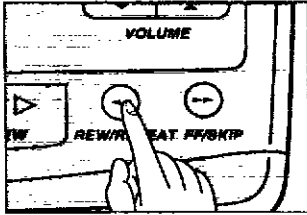

Press the REW/REPEAT button after playback.

- The new messages will be recorded from the beginning of the tape.

Erasing the recorded messages

After playback, you can erase the messages on the tape.

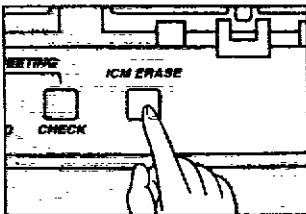

Press the ICM ERASE button.

- The unit erases the messages while the tape being rewound.
- To stop erasing, press the STOP button.

Recording your own message

You may record a personal message on the ICM tape. It can be heard by anyone playing back messages remotely or manually.

1

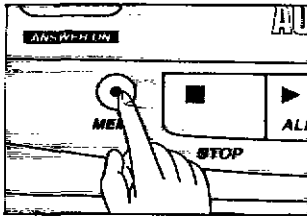

Press the MEMO button.

—A beep sounds.

2

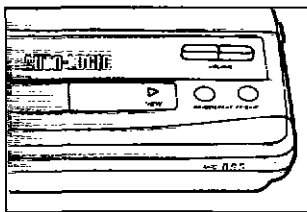

Immediately after the beep, speak clearly and loudly, 20 cm (8") away from the microphone.

—The IN USE indicator flashes.

3

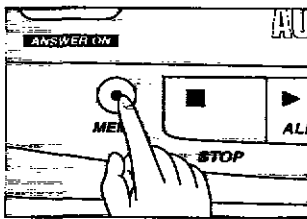

To stop recording, press the MEMO or the STOP button.

Monitoring incoming calls ---

While an incoming call is being recorded, you can monitor the caller's voice through the speaker and answer it if you want.

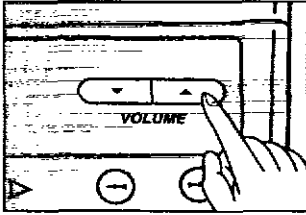

Adjust the volume using the VOLUME buttons.

Helpful hints:

- To answer a call while monitoring, lift the handset of any telephone on the same line. The unit will stop recording.
- You can also answer the call while the unit is playing the greeting message in the same way.

If the unit does not stop playing the greeting or recording the incoming message, press the hookswitch for about 1 second and then release it again.

Remote operation from a touch tone phone

You can operate your answering system remotely using a touch tone telephone while you are away from home.

You can identify a touch tone telephone because it has a * button, a # button and each button when pressed produces a different tone from any other button.

—For Toll Saver feature, see page 10.

Setting the remote code number

The remote code number prevents unauthorized persons from accessing your unit and listening to your messages. The remote code number is made up of 2-digit. The first digit is factory preset, and the second digit is selectable (2 or 8).

The first digit of your remote code number is shown on the label next to the remote code selector.

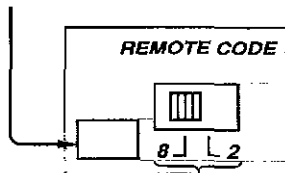

The second digit (2 or 8) is user's selectable.

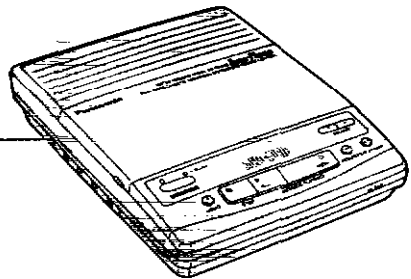

Example:

If the factory preset number is "4", your code number could be either "42" or "48" depending on the position of the REMOTE CODE selector.

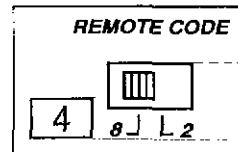

Direct remote operation (Basic)

1 Call your unit from a touch tone telephone.

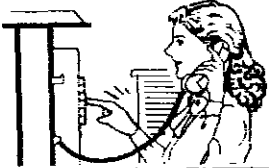

2 Press your remote code number during greeting message playback.

- Short beeps sound up to 8 times, to indicate the number of new messages.
- Proceed to step 3 within 5 seconds, or the unit plays back all the recorded messages.

1	2	3
4	5	6
7	8	9
*	0	#

Remote code no.

3 **To play back new messages only**

4

Press **4**.

- The unit plays back only the messages that you have not retrieved.

3 **To play back all messages**

5

Press **5**.

- The unit plays back all the recorded messages.

3 beeps sound at the end of playback.

4 Hang up. The messages are saved.

During playback

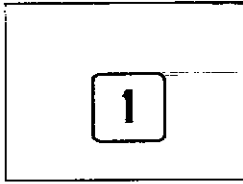

Repeating a message

Press **1**.

- The unit resumes playback at the beginning of the message.
- If you press “1” within 5 seconds of playing a message the unit will rewind to the start of the previous message.

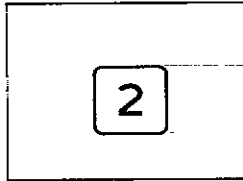

Skipping a message

Press **2**.

- The unit starts to play back the next message.

To reset the tape after playback

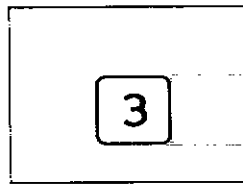

Press **3** within 5 seconds.

- When you play back all messages, the unit rewinds the tape to the beginning.
- When you play back only new messages, the unit rewinds the tape to the beginning of new messages and a beep sounds.

If you want to rewind the tape to the beginning after playing back only new messages:

Press **3** again after hearing a beep.

- The unit rewinds the tape to the beginning.

If you want to cancel the reset:

Press **2**.

Direct remote operation (Advanced)

1 Call your unit from a touch tone telephone.



2 Press your remote code number during greeting message playback.

- Short beeps sound up to 8 times, to indicate the number of new messages.
- Proceed to step 3 within 5 seconds, or the unit plays back all the recorded messages.



Remote code no.

3 **To re-record the greeting message**

- ① Press **7**.
 - A long beep sounds.
- ② Speak immediately after a long beep.
 - The recording time is up to 2 minutes 45 seconds.
 - Do not pause for over 4 seconds, or the call is terminated forcibly.
- ③ To stop recording, press **9**.
 - The newly recorded greeting message will be played back.

4 Hang up to end the remote operation.



To skip the greeting message (For outside callers)

Press during greeting message playback.

—Callers can record their messages without listening to your greeting message.

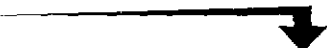

To turn the answering system off

Press button.

Your answering machine is automatically turned off.
Then, hang up.

To turn the answering system on

You can easily turn the answering system on from another location.

1

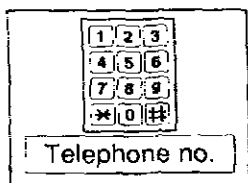

Call your unit.

2

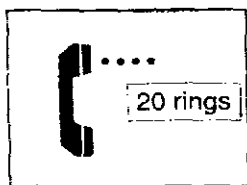

Wait for 20 rings.

—The unit will answer and the greeting message will be heard, hang up.

To record your own message

After playing back the recorded messages, you can leave your own message on the tape.

1. Wait for 10 seconds after hearing 3 beeps indicating the end of playback.
Then 2 beeps sound.
2. Start to speak after hearing 2 beeps.
3. To finish recording, hang up.

To continue playback

During remote operation, the unit will stop and 2 beeps will be heard in the following circumstances:

- 2 minutes 40 seconds after your unit answered.
- every 2 minutes 40 seconds after pressing a command button.

Press **9** within 10 seconds of the 2 beeps to listen to further messages.

OPERATION FROM TONE PHONE

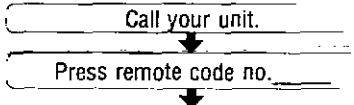
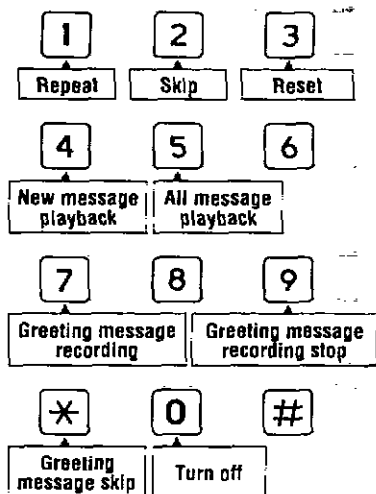

- To play back all messages, press **5**.
- To play back new messages, press **4**.
- For repeat, press **1**.
- For skip, press **2**.
- To reset the tape after playback, press **3**.
- To record your own message, speak after hearing 2 beeps at the end of playback.
- To save the messages, hang up after playback.

When you press any button, press it for about 1 second.

OPERATION FROM TONE PHONE

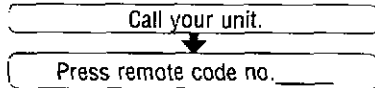
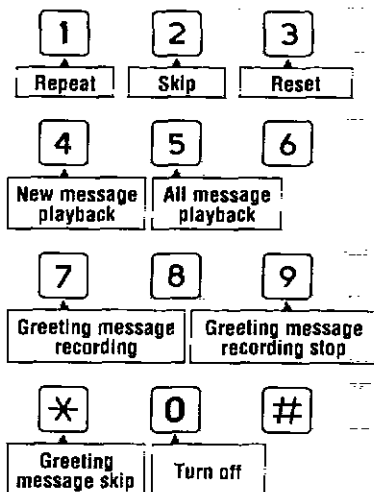

- To play back all messages, press **5**.
- To play back new messages, press **4**.
- For repeat, press **1**.
- For skip, press **2**.
- To reset the tape after playback, press **3**.
- To record your own message, speak after hearing 2 beeps at the end of playback.
- To save the messages, hang up after playback.

When you press any button, press it for about 1 second.

Call your unit.

To skip the greeting message, press ***7**.

Press remote code no. _____

To turn the answering system off, press **0** then hang up.

To re-record the greeting message;

1. Press **7**.
2. Speak after a long beep. Do not pause for over 4 seconds.
3. When finished, press **9**.

-To turn the answering system on, call your unit and wait for 20 rings. The unit will answer, then hang up.

-To continue playback, press **9** within 10 seconds of hearing the 2 beeps.

Call your unit.

To skip the greeting message, press ***7**.

Press remote code no. _____

To turn the answering system off, press **0** then hang up.

To re-record the greeting message;

1. Press **7**.
2. Speak after a long beep. Do not pause for over 4 seconds.
3. When finished, press **9**.

-To turn the answering system on, call your unit and wait for 20 rings. The unit will answer, then hang up.

-To continue playback, press **9** within 10 seconds of hearing the 2 beeps.

Troubleshooting guide

The unit does not work, and/or I cannot remove the tape from the unit.

—Plug in the AC adaptor again.

The answering system is on but no incoming messages are recorded.

- The REC TIME selector is set to the GREETING ONLY position. Change it to the VOX or 1 MIN position.
- The incoming message tape is full. Reset it (see page 20).
- The greeting message is recorded improperly or not recorded, so no one can leave a message. Check and record a new greeting message.
- The VOX SENS switch is set incorrectly for your telephone line. Try the other setting.

6 quick beeps sound during greeting message recording, and it results in failure.

- Re-record your greeting message.* Speak clearly and loudly, and do not pause for over 5 seconds while recording.

When a message is played back, the sound level is low, even if the volume is high.

- Clean the heads (see page 32).
- Replace the incoming message tape with a new one.

The unit does not answer remotely.

- The answering system is turned off. To set the unit to answer the call, call your unit and wait for 20 rings (see page 28).

I press the dial button of a touch tone phone after the unit answers, but the answering system does not respond.

- Make sure that you press your correct remote code number.* To check your remote code number (see page 23).
- The answering system may not respond if a remote touch tone phone produces tones that are too short to activate the unit (for example B.T. public telephones). If the telephone produces tones for as long as you hold down a button press each button for about 1 second each.
- If your unit does not respond you may need to purchase the optional remote controller KX-A74. Please contact your supplier for advice.

The incoming message tape continues to run after a caller hangs up.

- Set the VOX SENS selector to "LOW" (see page 11).
- Set the REC TIME selector to the 1 MIN position (see page 11).
- You may request B.T. to provide a CPC pulse (K-Break).

While operating the unit, the AC adaptor feels warm.

- This is a normal condition.

When you lift up the telephone handset to answer a call, the greeting is heard and it does not stop.

- Press the hookswitch on the telephone about 1 second. Then you can answer a call.

Maintenance

Tape deck

Since the head and capstan assemblies are in contact with the tape, dirt and residue from the tape may easily adhere to these parts, causing distortion. These parts should be cleaned periodically in the manner described below.

Clean the head surface, pinch roller and capstan with a cotton swab. If these surfaces are extremely dirty, wipe them with the cotton swab dampened with alcohol, then wipe them with a dry soft cloth.

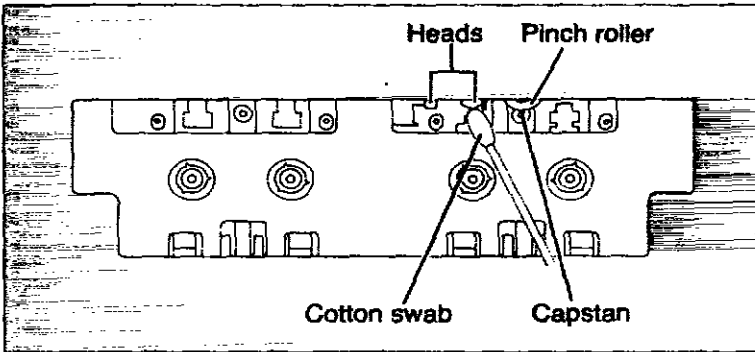

Notes:

- Do not bring magnetic or metal objects, such as a screwdriver, near the head assemblies, as such objects could magnetize the heads.
- Do not oil any part of the unit.

Cassette tape

- For optimum sound quality and performance, we recommend that you **use the opposite side (side-2) after six months and replace the tape with a new one every year, assuming that the unit answers about ten calls a day.**
- *Never place a cassette tape near a magnetic source, such as a magnet or a TV set; because it may erase or distort the recorded message on the tape.*
- Slack in the tape can be tightened by rotating the tape reel with an instrument like a pencil, as shown.

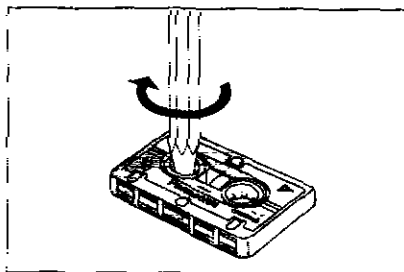

Cassette panel installation

If the panel comes off, replace it by pushing as shown.

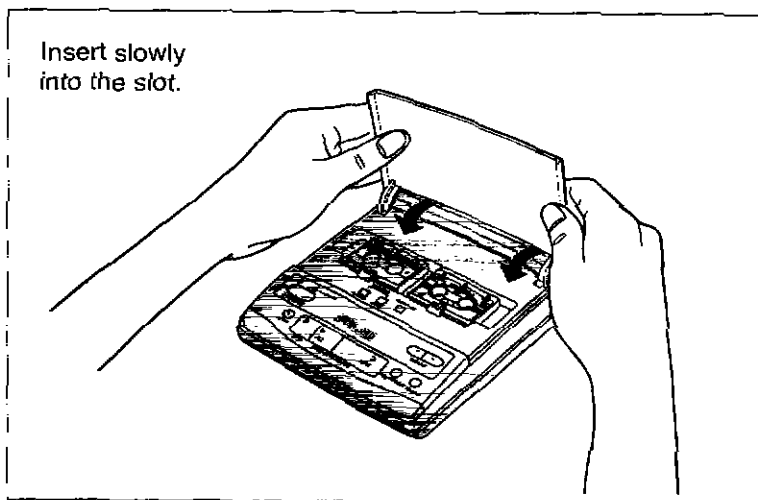

Safety instructions

Take special care to follow the safety suggestions listed below.

Safety

- 1) **Power Source:** The unit should be connected to a power supply only of the type described in the operating instructions or as marked on the unit.
- 2) **Non use Periods:** When the unit is not used, turn the power off. When left unused for a long period of time, the unit should be unplugged from the household AC outlet.

Installations

Environment

- 1) **Water and Moisture:** Do not use this unit near water—for example, near a bath tub, washbowl, sink, etc. Damp basements should also be avoided.
- 2) **Heat:** The unit should be situated away from sources of heat such as radiators, cookers, etc. It also should not be placed in rooms where the temperature is less than 5°C (41°F) or greater than 40°C (104°F).

Placement

- 1) **Stacking:** Do not place heavy objects on top of this unit.
- 2) **Foreign Material:** Care should be taken so that objects do not fall onto and liquids are not spilled into the unit. Do not subject this unit to excessive smoke, dust, mechanical vibration, or shock.
- 3) **Surface:** Place the unit on a flat level surface.
- 4) **Magnetism:** The unit should be situated away from equipment or devices that generate a strong magnetic field.

WARNING:

TO PREVENT THE RISK OF FIRE OR ELECTRICAL SHOCK, DO NOT EXPOSE THIS PRODUCT TO RAIN OR ANY TYPE OF MOISTURE.

MODEL No.
KX-T5006E

SERIAL No.

CUSTOMERS NAME etc. (BLOCK CAPITALS)

DEALERS

TELEPHONE No.

DATE OF PURCHASE

WE WOULD BE GRATEFUL IF YOU WOULD COMPLETE THE FOLLOWING BEFORE RETURNING THIS CARD FOR REGISTRATION.

Male Female Age ()

1. WHAT TYPE OF STORE?

- RADIO-TV GENERAL
- HI-FI, AUDIO SPECIALIST
- TELEPHONE SPECIALIST
- DEPARTMENT
- MAIL ORDER
- OTHER

2. WHEN YOU PURCHASED THIS UNIT DID YOU COMPARE WITH OTHER MODELS?

YES NO

MAKE

MODEL

PRICE

3. WHERE DO YOU PLAN TO USE?

- LIVING ROOM
- DINING ROOM
- OFFICE
- BEDROOM
- OTHER

4. HOW DID YOU LEARN OF THIS PRODUCT?

- AD. ON MAGAZINE/PAPER
- EDITORIAL IN MAGAZINE
- AD. ON HEARING
- AD. ON TV OR RADIO
- DISPLAY IN STORE
- CATALOGUE
- OTHERS

5. WHAT PERSUADED YOU TO BUY THIS UNIT?

- TRUST IN BRAND NAME
- HIGH QUALITY
- PRICE
- DEALERS RECOMMENDATION
- FRIENDS RECOMMENDATION
- TECHNICAL SPECIFICATION
- APPEARANCE AND DESIGN
- SIMPLE CONTROLS

6. IS THIS UNIT YOUR

- FIRST OWNED?
- REPLACEMENT?

7. HOW DO YOU RATE THIS MODEL ON THE SCALE FOR

EXCELLENT GOOD POOR

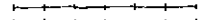
(a) PERFORMANCE 

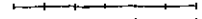
(b) FEATURES 

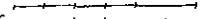
(c) DESIGN 

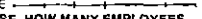
(d) VALUE VS. PRICE 

8. IF FOR BUSINESS USE, HOW MANY EMPLOYEES ARE THERE IN YOUR COMPANY?

UNDER 10 UNDER 50

UNDER 100 100+

9. YOUR COMMENTS IF ANY

Registered No. 1485987

CONNECTION REQUEST

For B.T. owned wiring:

The following subscriber requests you to install a wall socket to enable connection of a "direct exchange line." P.B.X. extension line for the Panasonic KX-T5006E Automatic Telephone Answering System which is fitted with a normal 431A connector

Approval Number S:010:3/R:503136

Subscriber

Address

Telephone Number Signature

*Delete if not required.

For wiring not owned by B.T.

Request should be made to the Authorized maintainer of the PBX for extension wiring and socket installation within 14 days. Expiry of the period of notice will allow another installer to be employed.

186

Panasonic Business Systems U.K.

Panasonic House, Willoughby Road, Bracknell,
Berkshire RG12 4FP

Printed in Japan

PQQX10823YA F0694Y0