

# Panasonic

CORDLESS PHONE

MODEL NO. **KX-T4066E**

# OPERATING INSTRUCTIONS



 **SOUND  
CHARGER**

Please read before use.

**Charge the battery for about 3 hours before initial use.**

# Important information

**APPROVED** for connection to telecommunication systems specified in the instructions for use subject to the conditions set out in them.

S/1010/3/R/503338

Do not connect the AC adaptor to any AC outlet other than the standard AC 230–240 V, 50 Hz.

- Outlet voltage DC 13.5 V, 400 mA
- The apparatus is approved for use with the KX-A11DSE or KX-A311E via KX-A91E power supply.
- CAUTION: Do not remove cover. Live parts inside.

This apparatus has been approved for the use of the following facilities:

- 1) Storage of telephone numbers for retrieval by a predetermined code
- 2) Last number redial
- 3) Simple telephone facility
- 4) PBX earth register recall  
PBX timed break register recall
- 5) MF signalling
- 6) LD signalling
- 7) Mercury dialling compatibility
- 8) Loudspeaking
- 9) Hold
- 10) Mute
- 11) Intercom

Any other usage will invalidate the approval of the apparatus if as a result, it then ceases to conform to the standards against which approval was granted.

## Ringer Equivalence Number (REN):

This relates to the performance of the apparatus when used in combination with other items of apparatus. It enables the calculation of the maximum number of items of apparatus that may be connected simultaneously to the line by summing the REN values of each item. A BT supplied instrument has a REN value of 1 unless otherwise marked. A maximum REN value of 4 should not be exceeded. The REN value of this apparatus is 1.

## Method of connection

This is connected to the exchange line or PABX/PMBX (Private Automatic/Manual Branch Exchange) extension by the new standard British Telecom plug and socket. Arrangements for provision of this type of termination can be made through the nearest British Telecom Sales Office. The apparatus may be connected to the following types of installation. The apparatus has been approved for use under the following conditions:

- a) This apparatus may be used on telecommunication systems employing LD and MF signalling. It is suitable for connection to a direct exchange line on the PSTN (Public Switched Telephone Network) or via a compatible PBX (Private Branch Exchange). (Contact the supplier for an up to date list of compatible PBX's.)

- b) This apparatus is not suitable as an extension to a payphone or for use on a party line with shared service.

This cordless telephone has been designed to operate on radio frequencies which have been assigned to the exclusive use of cordless telephones. As the use of cordless telephones becomes more widespread users may experience a reduction in the quality of service obtainable from this apparatus.

You may receive some interference on domestic radio receivers because the cordless telephone transmission is around 1.7 MHz.

There is a possibility of occurrence of overhearing between cordless telephones operating on the same radio channel. And such interference may increase with greater usage of cordless telephones.

999 or 112 can be dialled on the apparatus for the purposes of making outgoing calls to the BT Emergency (999 or 112) Service.

KX-T4066E



73/23/EEC  
89/336/EEC  
92/31/EEC  
93/68/EEC

#### **WARNING:**

The apparatus may be unable to make emergency 999 or 112 telephone calls, under certain conditions, e.g.

- Radio interference caused by another cordless telephone operating on the same radio frequency.
- The portable handset battery needs recharging, or has failed.
- The base unit back-up batteries are exhausted. With the batteries in good condition the base unit will be able to operate without mains power for at least seven hours, including one hour in the TALK mode.
- The portable handset cannot be used while charging.

Any cases of difficulty should be referred in the first instance to the supplier of the apparatus.

#### **NOTE:**

If you experience any problems with the normal use of your apparatus, you should unplug it from the telephone outlet and connect a known working telephone in its place. If the known working telephone still gives problems, then call British Telecom Engineers. If it operates properly, then the problem is likely to be a fault in your apparatus. In this case, contact your supplier for advice. British Telecom will charge you if they attend a service call that is not due to apparatus supplied by them.

# Contents ---

Important information . . . . .	2
Location of controls . . . . .	5
Installation . . . . .	7
Battery charge . . . . .	9
Operating range and noise . . . . .	10
Setting the selectors . . . . .	11
Making/Answering calls . . . . .	12
Automatic dialling . . . . .	14
Intercom between the handset and the base unit . . . . .	16
The Mercury Residential Service . . . . .	18
Other features . . . . .	21
Wall mounting . . . . .	22
Battery replacement . . . . .	23
Troubleshooting guide . . . . .	24
Connection to another telephone . . . . .	25
Safety instructions . . . . .	26

# Location of controls

## Handset

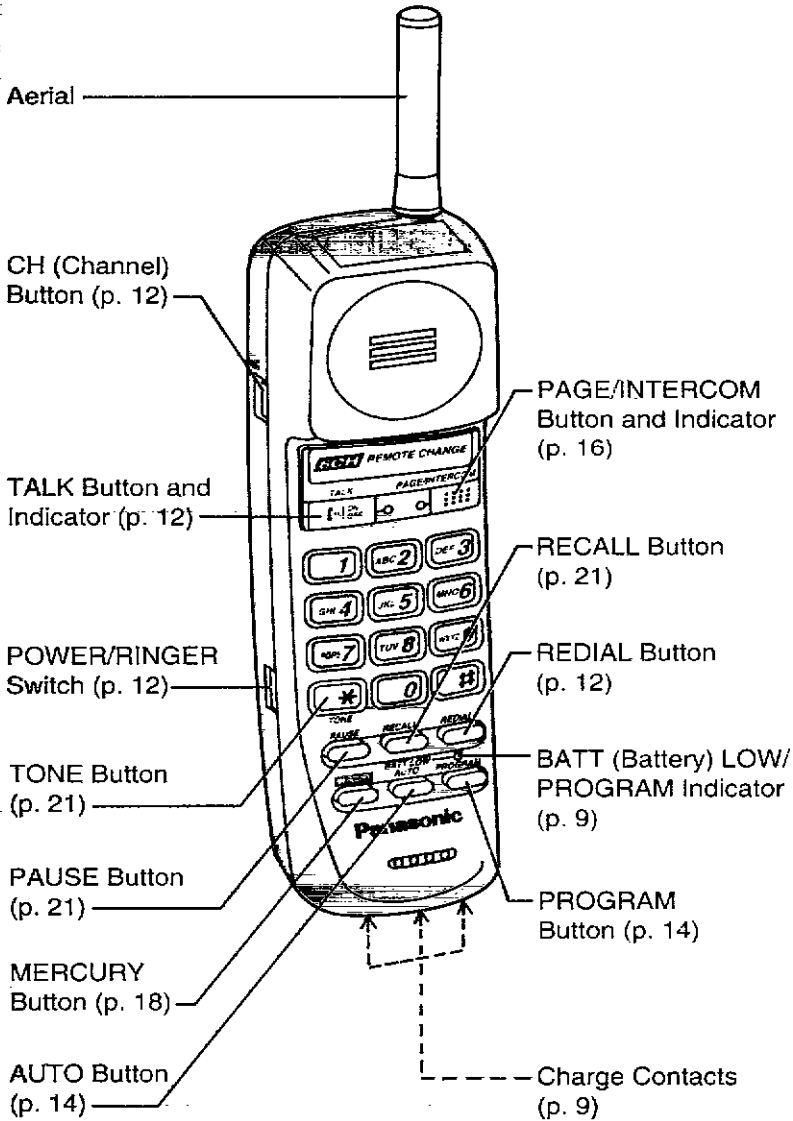

## Base unit

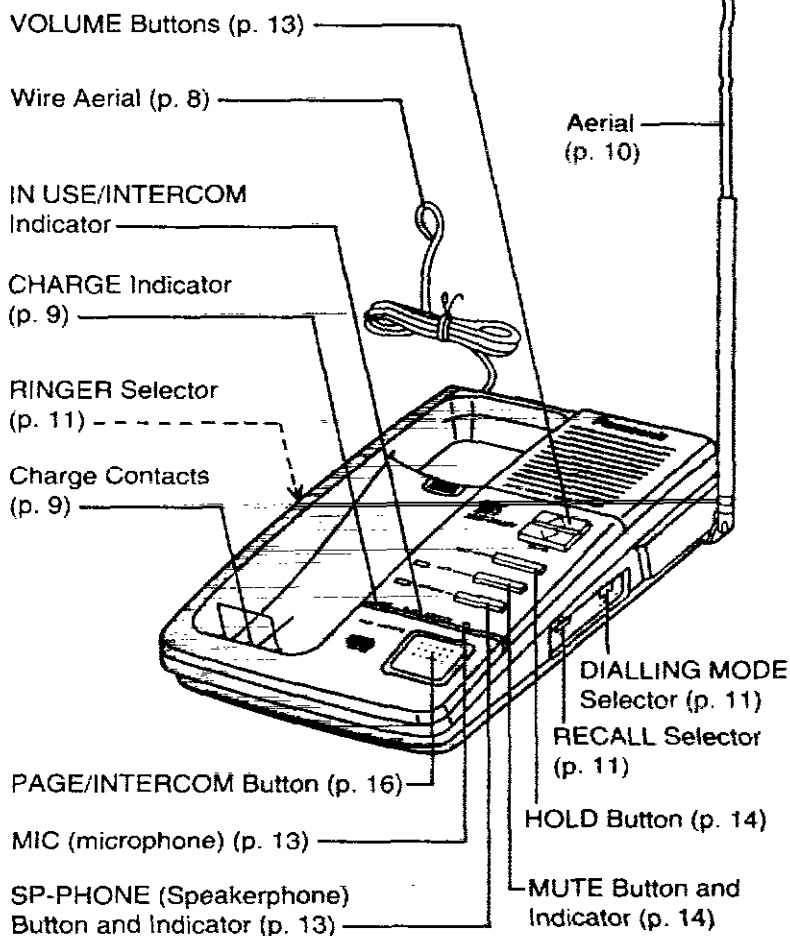

## Check the accessories

AC Adaptor  
(KX-A11DBE or  
KX-A311E)



one

Battery Box  
(KX-A91E)



one

Wall Mounting  
Adaptor



one

# Installation

## Connection

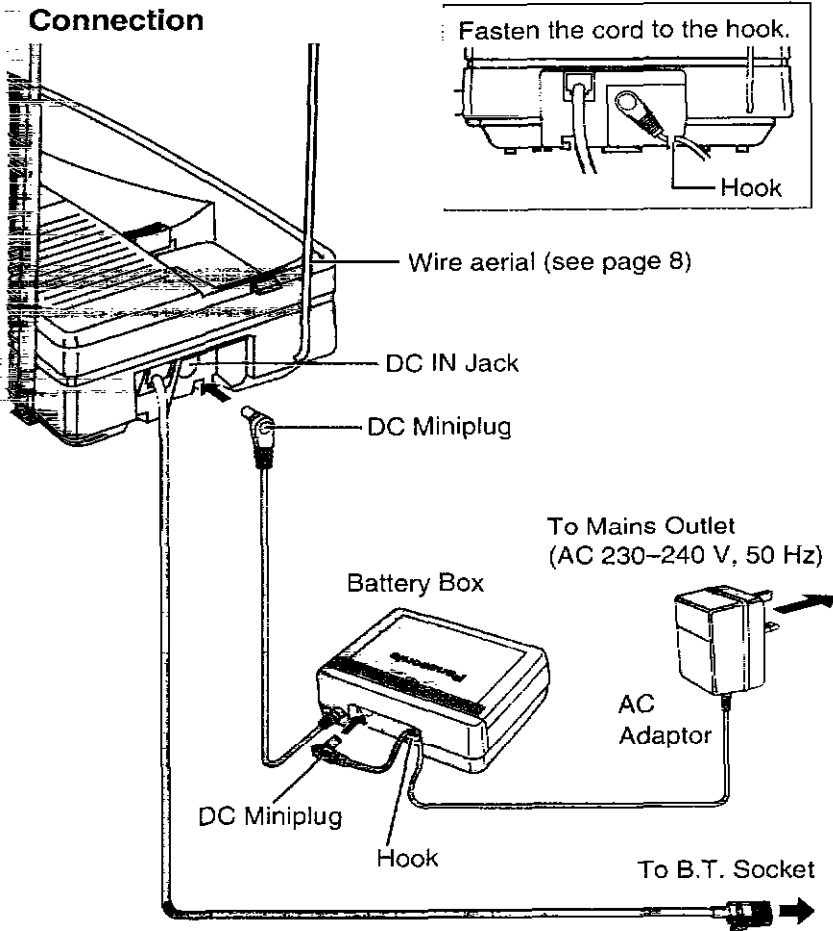

### Notes:

- USE ONLY Panasonic AC ADAPTOR KX-A11DBE OR KX-A311E VIA BATTERY BOX KX-A91E. These must remain connected at all times.
- The AC adaptor may feel warm during use. This is normal.
- If you connect a reserve telephone on the same line, see page 25.

### CONNECTION OF POWER SUPPLY

This apparatus is intended for use when powered by the KX-A11DBE or KX-A311E via KX-A91E. Using other power supplies will invalidate any approval given to this apparatus.

## To install wire aerial

The base unit has a wire aerial and a telescopic one. The wire aerial is used to transmit sounds to the handset while the telescopic aerial is used to receive them from the handset.

Uncoil the wire aerial to its full extent and fix its end at the highest position in your room. Avoid metal objects such as window frames for best performance.

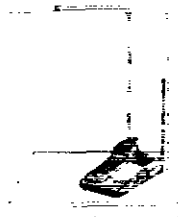

### Note:

—Do not cut the wire aerial or connect other wires.

## Battery Installation into the Battery box

Installing eight optional batteries (AA, R6 or UM-3 size) into the Battery box enables you to operate the unit during a power failure. You can use the unit for up to about 1 hour when new batteries are installed.

- 1** Loosen the screw and open the battery compartment.

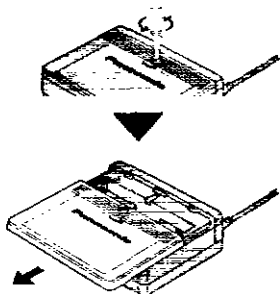

- 2** Insert the batteries in the proper order as indicated, matching the correct polarity.

—When you finish, close the cover and tighten the screw.

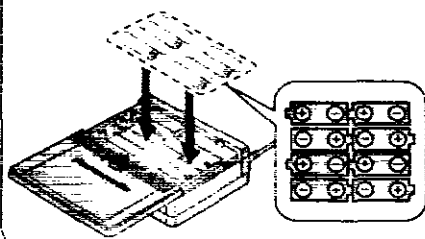

### Battery precautions:

The batteries should be used correctly, otherwise, the unit may be damaged due to battery leakage.

- Do not mix old, new or different types of batteries.
- Do not charge, short-circuit, disassemble, heat or dispose in fire.
- Do not use Nickel-Cadmium batteries.
- Please renew the batteries annually as a matter of routine.
- After a power failure has taken place, you should replace the batteries with new ones.
- Battery life depends on operating temperature and quality of batteries.



# Battery charge

To power the handset, charge the battery before initial use.  
Place the handset on the base unit for about 3 hours. The base unit must be connected to the mains for the handset to charge.

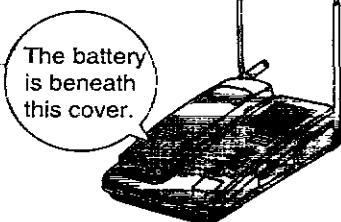

OR

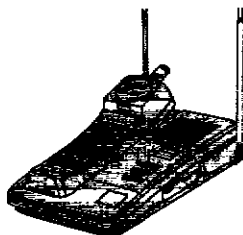

- The CHARGE indicator lights.
- The battery cannot be overcharged.
- Once the battery is fully charged, you do not have to place the handset on the base unit until the BATT.LOW/PROGRAM indicator flashes.

## Note:

—Clean the charge contacts with a soft cloth once a month, or the battery may not charge properly.

Recharge the battery when the BATT LOW/PROGRAM indicator flashes or beep tones sound every 15 seconds during a conversation.

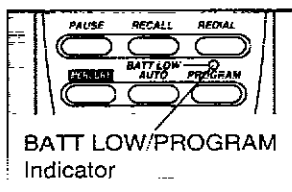

## ■ Standard battery life

If your Panasonic battery is fully charged, the expected usage time is:

While the phone is in use (TALK)	Up to about 7 hours
While the phone is not use (Stand-by)	Up to 14 days

Battery life may vary depending on actual use and ambient temperature.

## Operating range and noise

Calls are transmitted between the base unit and the handset using wireless radio waves. The range of operation depends on the construction of your home, weather or usage conditions.

Normally you may get a longer range outdoors than indoors. Obstacles such as metal shelves or cement-iron walls may shorten the operating range.

Electrical appliances such as a personal computer or TV might interfere with the telephone conversation or shorten the operating range. In this case, keep the base unit, telephone line cord or AC adaptor cord away from electrical appliances.

For maximum range, it is best to place the base unit at a HIGH and CENTRAL location of the house, with no obstructions or interference from electrical appliances. Extend the aerials of the base unit for best reception.

Away from such as a personal computer or TV.

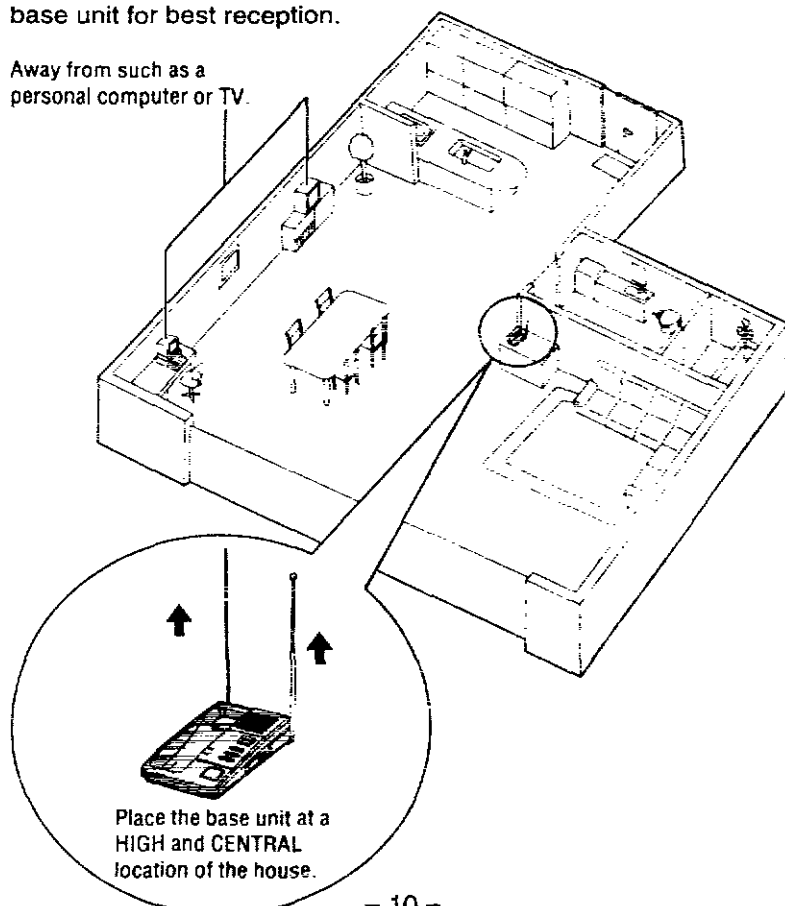

# Setting the selectors

## ① RINGER Selector

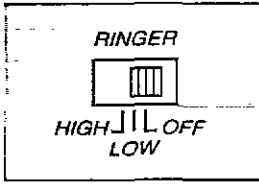

Select the ringer volume of the base unit. Set to "HIGH" or "LOW". When set to "OFF", the base unit will not ring.

## ② DIALLING MODE Selector

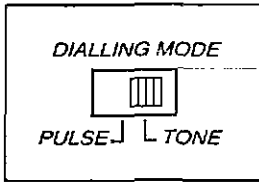

Set to "TONE" when your telephone line has touch tone service. If it has rotary service, set to "PULSE".

You can ascertain which type of local BT exchange you are connected to using the following procedure.

1. Ensure that the DIALLING MODE selector is set to "TONE".
2. Press **TALK**, then identify the dial tone.
3. Dial a number you are familiar with.
4. If the call is successful, you are connected to a Tone exchange, therefore leave the DIALLING MODE selector on "TONE".
5. If the call is not successful, you are connected to a Pulse exchange. Therefore, switch the DIALLING MODE selector back to "PULSE".

## ③ RECALL Selector

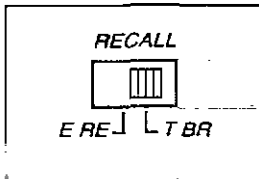

Set to "T BR" if the unit is to be connected directly to an exchange line. If the unit is to be connected via a PBX (switchboard) then you may need to switch to "E RE". If you are in any doubt, then please contact your switchboard manager or supplier for advice.

# Making/Answering calls

## Making calls with the handset

1 Press **TALK** to get dial tone. The indicator lights.

2 Dial a phone number.

Set to "ON", or the handset will not operate or ring.

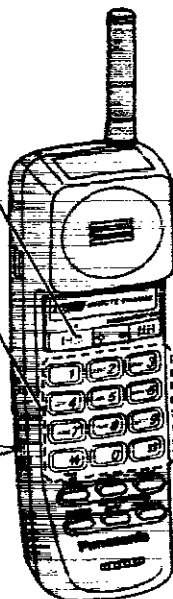

3 To hang up, press **TALK** or place the handset on the base unit. The indicator light goes out.

### Note:

—If alarm tone sounds when you press **TALK**, move toward the base unit or place the handset on the base unit. Then try again.

### ■ To redial

Press **TALK** to get dial tone, then press **REDIAL**. The last dialed number is automatically redialed.

### ■ If noise interferes with conversation

Press **CH** to select another of the 6 available channels.

—If the handset user is too far from the base unit, the **CH** button may not function fully. Move toward the base unit

## Answering calls with the handset

If the handset is off the base unit, press **TALK**.

If the handset is on the base unit, just lift it.

## Making calls with the base unit (Speakerphone)

You can make a call while leaving the handset on the base unit with the dialling buttons facing upward. You can also use **TALK** instead of **SP-PHONE**.

To increase the speaker volume, press **+** during a conversation.  
To decrease, press **-**.  
There are 12 levels.

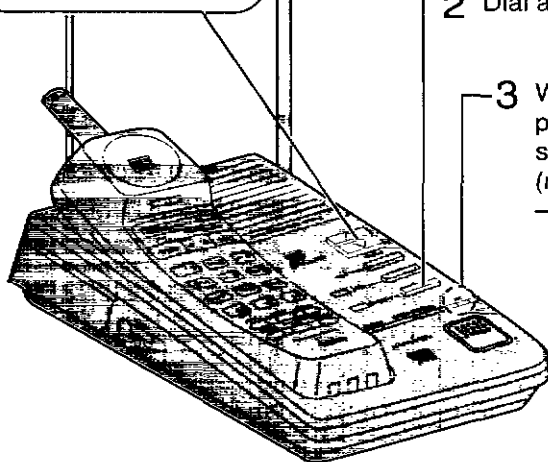

- 1 Press **SP-PHONE** to get dial tone.  
The indicator lights.
- 2 Dial a phone number.
- 3 When the other party answers, speak into **MIC** (microphone).  
— You can also lift the handset and speak.

- 4 To hang up, press **SP-PHONE**. The indicator light goes out.

## Answering calls with the base unit (Speakerphone)

Make sure that the **RINGER** selector is set to "HIGH" or "LOW", or the base unit will not ring.

Press **SP-PHONE**, then speak into **MIC**.

### During the speakerphone operation:

- Use the speakerphone in a quiet room for best performance.
- If the other party has difficulty hearing you, decrease the volume.
- If you and the other party speak at the same time, parts of your conversation will be inaudible. To avoid this, speak alternately.

## Putting a call on hold

Pressing **HOLD** during a conversation with the base unit enables you to put the call on hold. The **SP-PHONE** indicator light flashes. To resume the conversation, press **SP-PHONE**. If another telephone is connected on the same line, you can also release hold by lifting its handset.

### Note:

—If you place a call on hold for 6 minutes, warning ringing tone will sound. If the call is ignored, it will be released automatically after total 10 minutes.

## Muting your conversation

When you press **MUTE** during a conversation with the base unit, the other party cannot hear your voice, while you can hear theirs. The indicator lights. To resume the conversation, press **MUTE** again.

## Automatic dialling

The dialling buttons (0 through 9) function as memory locations. A 16-digit phone number can be stored in each location.

### To store phone numbers in memory

Make sure that the **TALK** indicator light is off.

- 1 Press **PROGRAM**.  
—The **BATT LOW/PROGRAM** indicator lights to show the unit is in the programming mode.
- 2 Enter a phone number up to 16 digits.  
—If you misdial, press **PROGRAM** to end the programming, then start from step 1.
- 3 Press **AUTO**.
- 4 Press a memory location number (0 through 9).  
—The phone number is stored there.  
—To store other numbers, repeat steps 1 through 4.

# Safety instructions

---

Take special care to follow the safety suggestions listed below.

## Safety

- 1) Power Source: The unit should be connected to a power supply only of the type described in the operating instructions or as marked on the unit.
- 2) Non use Periods: When the unit is not used, turn the power off. When left unused for a long period of time, the base unit should be unplugged from the household AC outlet.

## Installations

### Environment

- 1) Water and Moisture: Do not use this unit near water—for example, near a bath tub, washbowl, sink, etc. Damp basements should also be avoided.
- 2) Heat: The unit should be situated away from sources of heat such as radiators, cookers, etc. It also should not be placed in rooms where the temperature is less than 5°C (41°F) or greater than 40°C (104°F).

### Placement

- 1) Stacking: Do not place heavy objects on top of this unit.
- 2) Foreign Material: Care should be taken so that objects do not fall onto and liquids are not spilled into the unit. Do not subject this unit to excessive smoke, dust, mechanical vibration, or shock.
- 3) Surface: Place the unit on a flat level surface.

### For best performance

- 1) If noise prevents the conversation from being understood at the handset, move toward the base unit to reduce the noise.
- 2) The handset should be fully recharged on the base unit when the BATT LOW/PROGRAM indicator flashes.
- 3) The handset aerial should not be touched during use because of its high sensitivity.
- 4) The possible calling distance may be shortened when the unit is used in the following places: Near obstacles such as hills, tunnels, undergrounds, near metal objects such as wire fences, etc.

### WARNING:

TO PREVENT THE RISK OF FIRE OR ELECTRICAL SHOCK,  
DO NOT EXPOSE THIS PRODUCT TO RAIN OR ANY TYPE  
OF MOISTURE.

**I cannot page the handset from the base unit.**

- Set the **POWER/RINGER** switch to "ON".
- The handset is too far from the base unit or having an outside call.

**While having an intercom call, two tone are heard.**

- Someone is calling you from outside. To answer, press **TALK** or **SP-PHONE**. The intercom call is terminated.

**The BATT LOW/PROGRAM indicator flashes.**

**Beep tones sound every 15 seconds during a conversation.**

- Charge the battery fully (p. 9).

**I charged the battery fully, but the BATT LOW/PROGRAM indicator flashes after a few telephone calls.**

- Clean the charge contacts and charge again.
- It is time to change the battery. Please replace with a new one (p. 23).

**The CHARGE indicator light never goes out while the handset is on the base unit.**

- This is normal.

**I cannot use the unit during a power failure.**

- The unit will not function during a power failure. We recommend that you install eight optional batteries in the Battery box for power failure protection (p. 8).
- You can connect a reserve telephone on the same line for power failure protection (see below).

## Connection to another telephone —

To B.T. Socket

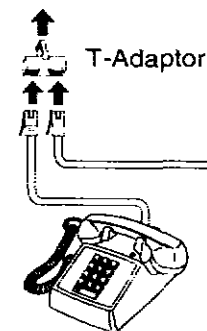

Another Telephone

If you connect a reserve telephone on the same line, please use a T-adaptor.

Telephone Line Cord

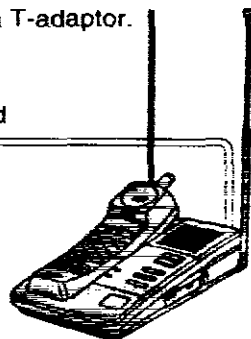



# Troubleshooting guide

---

## **The unit does not work.**

- The connection of the unit was made improperly (p. 7).
- The handset has become discharged. Recharge the battery (p. 9).
- The security codes in the handset and the base unit are not the same. Place the handset on the base unit.
- Connect your unit to the main (first) socket in your premises. If it operates correctly then there is a fault in your extension wiring, if it still fails to ring then contact your supplier for advice.

## **The unit stops working during operation.**

- Disconnect the AC adaptor and set the POWER/RINGER switch to "OFF" to reset. Reconnect the AC adaptor and set the switch to "ON", then try again.

## **Static, sound cuts in and out, fades. Interference from other units.**

- Electrical interference may cause static and poor range. Set the handset and the base unit away from other electrical appliances.
- You may be too far from the base unit. Move toward it.
- Extend the wire and telescopic aerials of the base unit fully (p. 8, 10).
- Change the channel.

## **When I press the TALK or PAGE/INTERCOM button, alarm tone sounds.**

- Move toward the base unit and try again.
- Place the handset on the base unit and try again.
- Make sure that the AC adaptor is connected.

## **The handset does not operate or ring.**

- The POWER/RINGER switch is set to "OFF". Set to "ON".

## **The base unit does not ring.**

- The RINGER selector is set to "OFF". Set to "HIGH" or "LOW".

## **I cannot store a phone number in memory.**

- You cannot store the number while the unit is in the talk mode or intercom mode.
- Do not pause for over 30 seconds while storing.

## **While storing a phone number, the unit starts to ring.**

- To answer the call, press **TALK** or **SP-PHONE**. The programming will be cancelled, store the phone number again.

# Battery replacement

Replace the battery with a new one if the BATT LOW/PROGRAM indicator flashes after a few telephone calls, even when the battery has been charged for 3 hours.

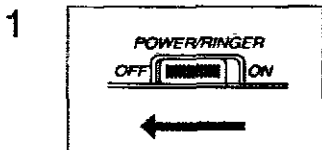

Set the POWER/RINGER switch on the handset to "OFF", in order to prevent memory loss.

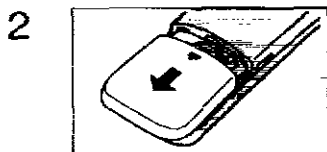

Remove the battery compartment cover.

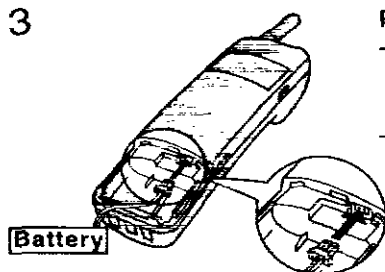

Replace the battery  
—When you finish, close the cover and set the POWER/RINGER switch to "ON".  
—Complete the replacement within 5 minutes, or memory may be lost.

## Notes:

- Please only use a Panasonic KX-A36A battery.
- Remember to charge the battery for about 3 hours after battery replacement.
- At the end of its useful life, the nickel-cadmium battery must be disposed of properly.

# Wall mounting

This unit can be wall mounted on a wall using screws and washers together with suitable wall fixings, if required.

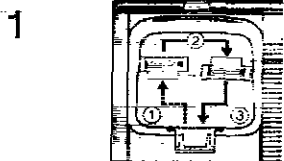

Remove the handset guide from the base unit (①) then turn over (②) and replace it with the tab upward (③).

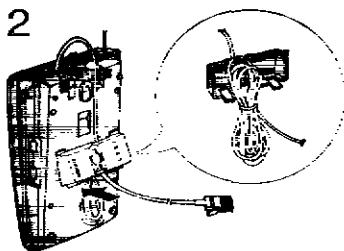

Tuck the telephone line cord inside the wall mounting adaptor.

Insert the tabs of the adaptor into the openings of the unit, then push it in the direction of the arrow. "UP" should face upward.

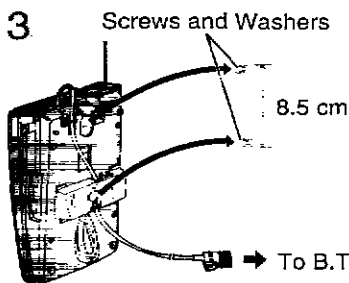

Install screws and washers using the wall template indicated on this page.

Connect the telephone line cord to B.T. socket, then mount the unit securely on the screws as shown.

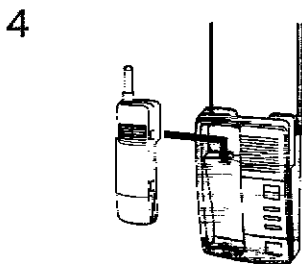

## To charge the battery:

Place the handset as shown.

- The CHARGE indicator lights.
- The handset cannot be mounted on the base unit with the dialling buttons facing upward.

## Note:

- The battery continues to charge in the wall mount position. It cannot be overcharged.

## Wall Template

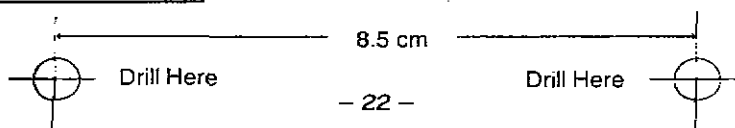

## Other features

---

### For PBX users

If your unit is connected to a PBX, you need to dial an access number (usually 9) to get an outside line. In this case, inserting a pause between the access number and the phone number is necessary, especially when redialling or storing the number in memory. Pressing **PAUSE** once causes a 3.5-second pause.

### Temporary tone dialling

If your line has rotary service, pressing **TONE** (\*) allows you to change the dialling mode temporarily to tone. You can dial the numbers or codes needed to operate an answering system, to use electronic banking services or other special services. When you hang up, the dialling mode returns to pulse automatically.

### Automatic security code setting

Whenever you place the handset on the base unit, the unit automatically selects one of 60,000 security codes. This code helps to avoid unauthorized use of your telephone line by another cordless telephone in your area.

### Using the recall feature

The **RECALL** button is used to access special telephone services (optional) such as call waiting. Contact your telephone company business office for details.

Example: British Telecom call waiting

1. Ensure that you have set the **RECALL** selector to "T BR".
2. When the call waiting tone is heard during a conversation, press **RECALL**.
3. When dial tone is heard, dial 2.  
The first call is put on hold and you can have a conversation with the second party.
4. **To keep the present call and return to the first call:**  
Press **RECALL**, then dial 2.  
**To hang up the first call:**  
Press **RECALL**, then dial 0.  
**To hang up the present call and return to the first call:**  
Press **RECALL**, then dial 1.

If your unit is connected to a PBX, pressing **RECALL** allows you to access some features of your host PBX such as transferring an extension call.

## ■ Confirming the Mercury station's memory

Store the Mercury code you want to confirm in the Mercury button. If you hear 1 beep, the code is newly stored in the memory. If you hear 2 beeps, the code is same as previously stored one. If you hear 6 beeps, the code is different from previously stored one. To store the code newly, reset the Mercury memory, then reprogram.

## Making a call via Mercury

- 1 Press **TALK** to get dial tone.
- 2 Press **MERCURY**.  
—A series of short beeps will be heard.
- 3 Dial the chosen Cost Centre Code\* (any 2 or 3 digit number except 112 or 999) **If applicable** (see below).
- 4 Dial either the phone number required, or automatic dial memory.

**Please note that Cost Centre Codes are not currently available with Residential 132 Service.**

### \*Cost Centre Codes

Cost Centre Codes are selectable on your Mercury order form. By keying in a code number (either 2 or 3 digits) before dialling each and every Mercury call, businesses can allocate calls to different jobs, or residential users can see who is responsible for each call.

## Resetting the Mercury memory (Returning to Residential 132 Service)

If you want to change your Mercury code to a new one or if you need to send your telephone away for repair, you must reset the Mercury memory using the following procedure.

- 1 Press **PROGRAM**.  
—The BATT LOW/PROGRAM indicator lights to show the unit is in the programming mode.
- 2 Press **MERCURY**.
- 3 Press **AUTO**.  
—The Mercury memory is reset to 132 (Residential 132 Services). You can store a new Mercury code (see page 19).

## For Mercury PIN Codes Service customers

After you apply for Mercury PIN Codes Service you will receive a Mercury PIN code in two separate parts. The PIN code, which is similar to a bank PIN number, identifies you as a Mercury customer and will need to be stored in the unit's memory using the MERCURY button.

### ■ Programming the MERCURY button

Before programming your unit with the Mercury PIN code:

- 1) You must ascertain which type of local BT exchange you are connected (p. 11).
- 2) Reset the Mercury station's memory (p. 20).

**Ensure that the unit is plugged into the BT socket.**

- 1 Press **PROGRAM**.  
—The BATT LOW/PROGRAM indicator lights to show the unit is in the programming mode.
- 2 Press **MERCURY**.
- 3 Dial 131.
- 4 **If you are connected to a Tone exchange;**  
Press **PAUSE** once (twice if programming proves unsuccessful).  
OR  
**If you are connected to a Pulse exchange;**  
Press \* (**TONE**), then press **PAUSE** once.
- 5 Enter the digits of the Mercury PIN code (part 1 then part 2).  
—To correct an error while programming, press **PROGRAM**, then proceed from step 1 again.
- 6 Press **AUTO** to store the program into memory.

### **Note:**

—If programming proves unsuccessful reset the Mercury memory as described on page 20 then re-program the memory from step 1.

To check if the PIN code has been programmed correctly, press the TALK button, wait for the dialling tone, and press the MERCURY button (followed by 2 or 3 digit Cost Centre Code\* if applicable) and dial 1500. This call is free of charge. During connection you will hear a series of short beeps. This is the Mercury dial tone. After a few seconds you should be connected to a recorded message welcoming you to the Mercury network. If you have any difficulties, please contact Mercury Customer Services on FreeCall 0500-500 193 (24 hours). (\*Cost Centre Code: see page 20.)

# The Mercury Residential Service —

Mercury's Residential Service is a highly competitive telephone service for the residential and small business user.

Most UK long distance and international calls are cheaper over Mercury, especially in the Economy period.

Mercury calls are rounded to the second, and charged to the nearest tenth of a penny. You will also receive fully itemized bills. Mercury Customer Services are available 24 hours a day to provide the highest level of customer service.

There are two ways to access Mercury, the Residential 132 Service and the Mercury PIN Codes Service. You can find out the best method for you by calling Mercury Customer Services on FreeCall 0500-500 194 (24 hours). Most homes and businesses are now able to access the Mercury network via their existing BT line. Mercury Customer Services will be able to check whether Mercury is available in your area.

All Mercury's charges and tariffs are the same for both methods of accessing Mercury—the only difference is how you connect to the Mercury network.

## For Residential 132 Service customers

Once you have become a Mercury Residential 132 customer, you simply dial 132 before a long distance or international call to send it over the Mercury network.

**The MERCURY button on your unit comes with the digits "132" pre-stored in it.**

To check that you have access to Mercury, press the TALK button, wait for the dial tone, press the MERCURY button, and dial 132. This call is free of charge. You should be connected to a *recorded message welcoming you to the Mercury network*. If you have any difficulties, please contact Mercury Customer Services (Fault Reporting) on FreeCall 0500-500 193 (24 hours).

To send your long distance and international calls over Mercury, press the MERCURY button before the STD code and telephone number of the person you are calling.

### **During the intercom:**

- You can adjust the speaker volume with the **VOLUME** buttons. If the other party has difficulty hearing you, decrease the volume.
- If two tones sound, someone is calling from outside. To answer it, press **TALK** or **SP-PHONE**. The intercom is ended.

## **Transferring a call using the intercom**

The intercom can be used during an outside call. This feature enables you to transfer the call between the handset and the base unit.

### **■ Transferring from the handset to the base unit**

1. **Handset:** During a conversation, press **PAGE/INTERCOM** to page the base unit.
  - The outside call is put on hold.
2. **Base unit:** When the paging party's voice is heard, answer through **MIC**.
3. **Base unit:** To answer the outside call, press **SP-PHONE**.
  - The transfer is completed.
  - Handset user can join the conversation by pressing **TALK**.

### **■ Transferring from the base unit to the handset**

1. **Base unit:** During a conversation, press **HOLD** to put the outside call on hold.
  - The **SP-PHONE** indicator flashes.
2. **Base unit:** Press **PAGE/INTERCOM** to page the handset.
3. **Handset:** Press **PAGE/INTERCOM** to answer the page.
4. **Handset:** To answer the outside call, press **TALK**.
  - The transfer is completed.
  - Base unit user can join the conversation by pressing **SP-PHONE**.

### **Note:**

- While having a three way conversation, the quality of the sound may be a little impaired, this is not a fault condition.



# Intercom between the handset and the base unit

2-way intercom is available between the handset and the base unit. Intercom calls can only be ended by the handset.

## ■ Paging the base unit from the handset

- 1 Press **PAGE/INTERCOM**, then speak.

—To end the intercom, press again.

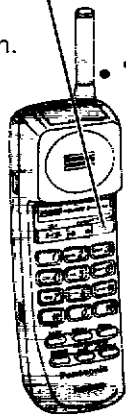

- 2 When the other party's voice is heard, answer through **MIC**.

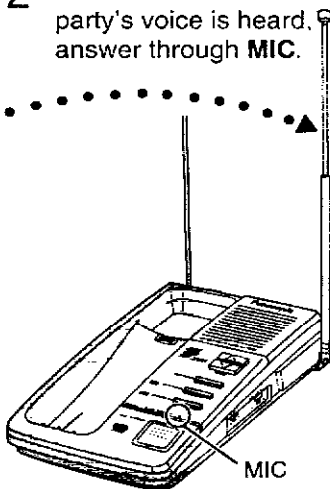

## ■ Paging the handset from the base unit

- 1 Press **PAGE/INTERCOM**.

—To end the page, press again.

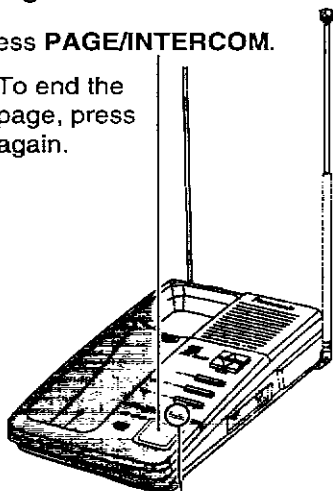

- 2 Press **PAGE/INTERCOM** to answer.

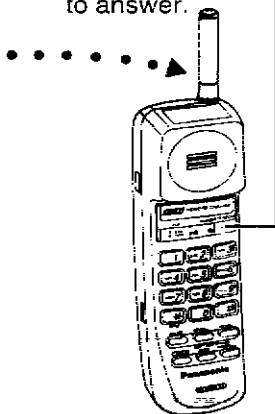

- 3 Speak into **MIC**.

- 4 To end the intercom, press **PAGE/INTERCOM**.

### ■ To confirm a stored number

Store the phone number again in the same memory location. If you hear 2 beeps, the newly stored number is the same as the previously stored one. If you hear 1 beep, the number is different.

### ■ To erase a stored number

1. Press **PROGRAM**, then **AUTO**.
2. Press the memory location of the phone number to be erased.

### ■ Memory card

Pull out the memory card and write down the names or phone numbers associated with automatic dialling.

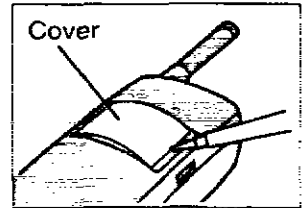
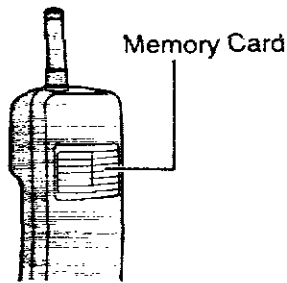

### To dial a stored number from memory

- 1 Press **TALK** to get dial tone.
- 2 Press **AUTO**.
- 3 Press the memory location number (0 through 9).  
—The stored number is dialled automatically.

MODEL No.  
KX-T4066E

SERIAL No.

CUSTOMERS NAME etc. (BLOCK CAPITALS)

DEALERS

TELEPHONE No.

DATE OF PURCHASE

WE WOULD BE GRATEFUL IF YOU WOULD COMPLETE THE FOLLOWING BEFORE  
RETURNING THIS CARD FOR REGISTRATION

Male  Female Age ( )

1. WHAT TYPE OF STORE?

- RADIO-TV GENERAL
- H.F. AUDIO SPECIALIST
- TELEPHONE SPECIALIST
- DEPARTMENT
- MAIL ORDER
- OTHER

2. WHEN YOU PURCHASED

THIS UNIT DID YOU

COMPARE WITH OTHER

MODELS?

YES  NO

MAKE

MODEL

PRICE

3. WHERE DO YOU PLAN TO

USE?

- LIVING ROOM
- DINING ROOM
- OFFICE
- BEDROOM
- OTHER

4. HOW DID YOU LEARN OF

THIS PRODUCT?

- AD ON MAGAZINE PAPER
- EDITORIAL IN MAGAZINE
- AD ON HOBBYING
- AD ON TV OR RADIO
- DISPLAY IN STORE
- CATALOGUE
- OTHERS

5. WHAT PERSUADED YOU TO

BUY THIS UNIT?

- TRUST IN BRAND NAME
- HIGH QUALITY
- PRICE
- DEALERS RECOMMENDATION
- FRIENDS RECOMMENDATION
- TECHNICAL SPECIFICATION
- APPEARANCE AND DESIGN
- SIMPLE CONTROLS

6. IS THIS UNIT YOUR

- FIRST OWNED?
- REPLACEMENT?

7. HOW DO YOU RATE THIS MODEL ON THE

SCALE FOR:

- (a) PERFORMANCE
- (b) FEATURES
- (c) DESIGN
- (d) VALUE VS PRICE

8. IF FOR BUSINESS USE, HOW MANY

EMPLOYEES ARE THERE IN YOUR COMPANY?

UNDER 10  UNDER 50

UNDER 100  100+

9. YOUR COMMENTS IF ANY

Registered No. 1485987

## CONNECTION REQUEST

For B.T. owned wiring.

The following subscriber requests you to install a wall socket to enable connection of a "direct exchange line" PBX extension line for the Panasonic KX-T4066E Cordless Telephone which is fitted with a normal 431A connector.

Approval Number S:10103/R:503338

Subscriber .....

Address .....

Telephone Number ..... Signature .....

\*Delete if not required.

For wiring not owned by B.T.

Request should be made to the Authorized maintainer of the PBX for extension wiring and socket installation within 14 days. Expiry of the period or notice will allow another installer to be employed.

STAMP  
REQUIRED

# Panasonic Business Systems U.K.

WILLOUGHBY RD.  
BRACKNELL, BERKSHIRE  
RG12 4FP

X

## POST CARD

STAMP  
REQUIRED

**The Telephone Manager  
British Telecom Sales Department**

..... Area  
.....  
.....

## GUARANTEE

### CONDITIONS OF GUARANTEE

This guarantee is in addition to and does not in any way affect any statutory or other rights of consumer purchasers. If within the applicable guarantee period, the appliance proves to be defective by reason of faulty design, workmanship or materials, we undertake subject to the following conditions to have the defective appliance (or any part or parts thereof) repaired or replaced free of charge.

1. The appliance shall have been purchased and used solely within the UK and in accordance with standard operating instructions and the technical and/or Safety Standards required in the UK.
2. The purchaser will within 7 days of purchase complete the included card and send it to us for registration. Failure to return such card could result in delay in providing the guarantee service.
3. The appliance should be returned together with this guarantee and proof of date of purchase promptly on being found defective at the purchaser's risk and expense to the authorized dealer from whom the appliance was purchased or to the nearest authorized dealer. All enquiries must be through such dealers.
4. This guarantee shall not apply to damage caused through fire, accident, lightning, misuse, wear and tear, neglect, incorrect adjustment or repair, to damage caused through installation, adaption, modification or use in an improper manner or inconsistent with the technical and/or safety standards required in the country where this appliance is used, or to damage occurred during transit to or from the purchaser.
5. If at any time during the guarantee period any part or parts of the appliance are replaced with a part or parts not supplied or approved by us or of an objective quality safe and suitable for the appliance, or the appliance has been dismantled or repaired by any person not authorized by us, we shall have the right to terminate this guarantee in whole or in part immediately without further notice.
6. The purchaser's sole and exclusive remedy under this guarantee against us is for the repair or replacement of the appliance or any defective part or parts and no other remedy, including, but not limited to, incidental or consequential damage or loss of whatsoever nature shall be available to the purchaser.
7. This guarantee shall not apply to cassette tapes, batteries and any other items of limited natural life.
8. Our decision on all matters relating to complaints shall be final. Any appliance or defective part which has been replaced shall become our property.
9. The guarantee period applicable to this product shall be 12 months.

Please keep these Operating Instructions with your receipt.

#### **Panasonic Business Systems U.K.**

---

Receipt No.	Date of Purchase
-------------	------------------

---

Model No. <b>KX-T4066E</b>	Serial No.
----------------------------	------------

---

131

**Matsushita Electric Industrial Co., Ltd.**  
Central P.O. Box 288, Osaka 530-91, Japan

Printed in Japan

**PQQX11418ZA** F0595B0