

Operating Instructions

CORDLESSPHONE

MODEL NO. **KX-T3816BE**

Easa-Phone

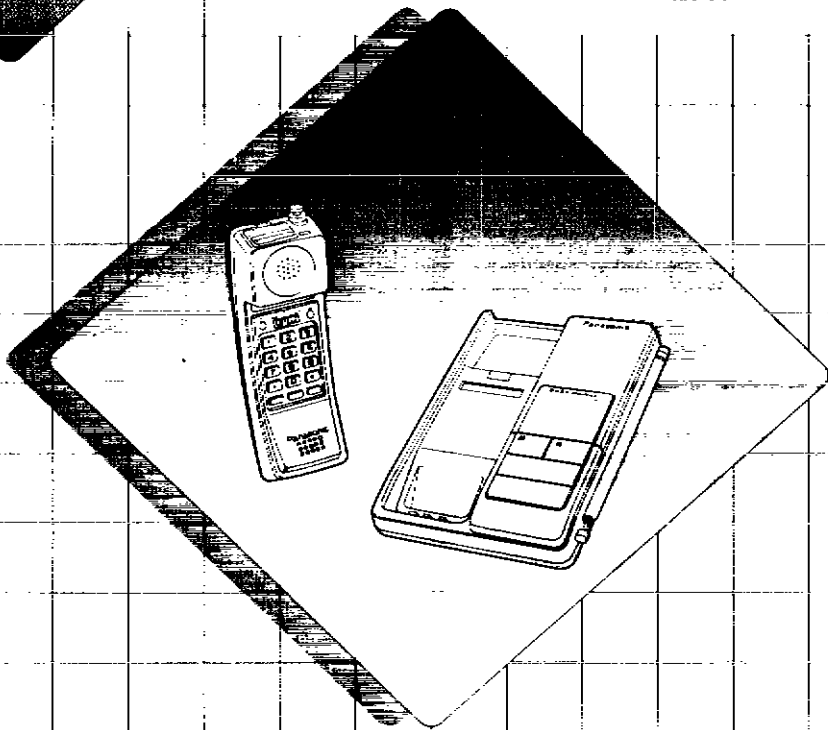

Panasonic

Please read before use.

Charge the battery for about 10 hours by setting the Function Selector to the "OFF" position before initial use.

Thank you for purchasing this Panasonic Telephone.

Ringer Equivalence Number (REN):

This relates to the performance of a telephone when used in combination with other items of apparatus. It enables the calculation of the maximum number of items of apparatus that may be connected simultaneously to the line by summing the REN values of each item. A maximum REN value of 4 should not be exceeded.

The REN value of this cordlessphone is 1.

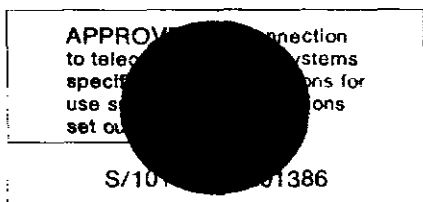

NOTE:

- If you experience any problems with the normal use of your unit, you should unplug it from the telephone outlet and connect a known working telephone in its place. If the known working telephone still gives problems, then call British Telecom Engineers; if it operates properly, then the problem is likely to be a fault in your unit. In this case, contact your supplier for advice.
- British Telecom will charge you if they attend a service call that is not due to equipment supplied by them.

WARNING

Under certain conditions the KX-T3816BE may be unable to make emergency 999 telephone calls.

- Radio interference caused by another cordlessphone operating on the same radio frequency.
- The portable unit needs recharging.
- The base unit back-up batteries are exhausted. With the batteries in good condition the base unit will be able to operate without mains power for at least seven hours, including one hour in the TALK mode.
- The portable unit cannot be used while charging.

Method of connection

The Ease-Phone is connected to the exchange line or PABX/PMBX extension by the new standard British Telecom plug and socket. Arrangements for provision of this type of termination can be made through the nearest British Telecom Sales Office.

The Easa-Phone may be connected to the following types of installation. The telephone has been approved for use under the following conditions;

- (a) For connection to the public switched telephone network (PSTN) and compatible (Private Branch Exchange), which use loop disconnect signalling. (Please consult your supplier for an up to date list of compatible PBX's.)
- (b) The telephone can be used on extension sockets connected to a direct exchange line. (D.E.L.)
- (c) This apparatus is suitable for connection to the telecommunication system directly or via compatible private branch exchange as an extension. This unit is suitable for connection to a PBX which returns secondary proceed indication.
The supplier of the apparatus should be consulted for an up to date list of PBX's with which the apparatus is compatible.

It cannot be guaranteed that the apparatus will operate under all possible conditions of connection to compatible PBX's.

Any cases of difficulty should be referred in the first instance to the supplier of the apparatus.

This apparatus has been approved for the use of the following facilities:

- 1) Automatic storage of last number dialed
- 2) Repeat attempt facilities: (a) single
- 3) Simple telephone facility
- 4) PBX Time Break. Switchable Time Break/Earth Recall for PBX.
- 5) Loop disconnect signalling
- 6) MF signalling
- (d) The telephone must not be connected in the following manner:
 - 1) As an extension to a pay phone
 - 2) As a party line with shared service
 - 3) As part of A 1 + 1 carrier system

Any other usage will invalidate the approval of the apparatus if as a result, it then ceases to conform to the standards against which approval was granted.

Connection

CONNECTION OF POWER SUPPLY. THIS APPARATUS IS INTENDED FOR USE WHEN SUPPLIED WITH POWER FROM KX-A14BE. OTHER USAGE WILL INVALIDATE ANY APPROVAL GIVEN TO THIS APPARATUS IF AS A RESULT IT CEASES TO COMPLY WITH BS6301: 1982.

- This unit is designed to be connected as shown.

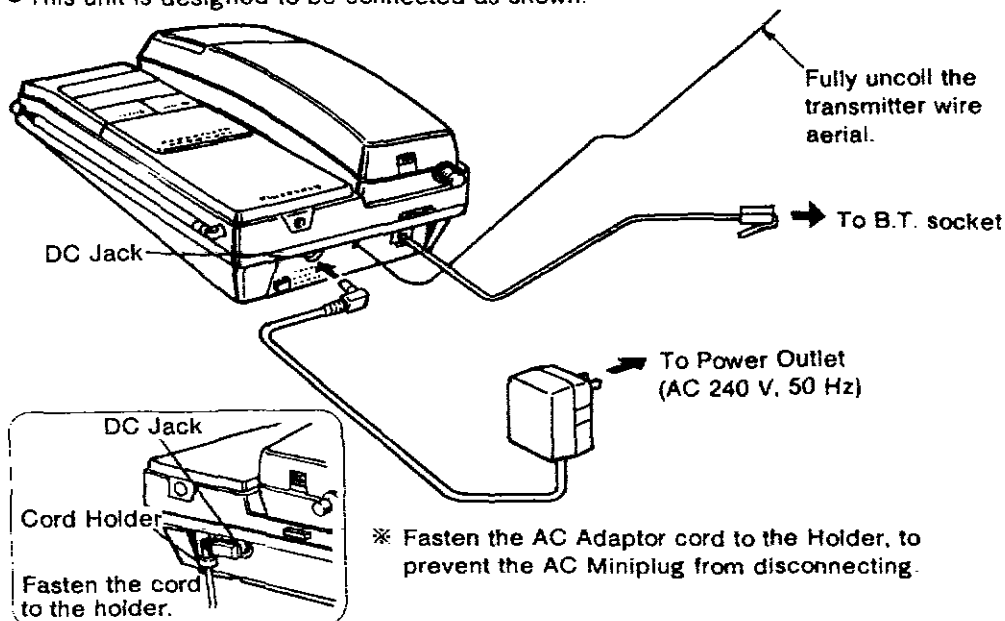

- The AC adaptor supplies the unit with operation power.
 - Do not use any AC adaptor other than the Panasonic Model KX-A14BE.
 - While operating the unit the cabinet may feel warm, this is quite normal.
- (WARNING. CONNECT ONLY APPARATUS COMPLYING WITH BS6301) TO THIS PORT.**

Be sure to use the AC Adaptor. If a power failure takes place, the unit can be used as a typical telephone.

999 can be dialled on the apparatus for the purposes of making outgoing calls to the BT emergency (999) Service.

Preparation

- 1 Connect as shown.

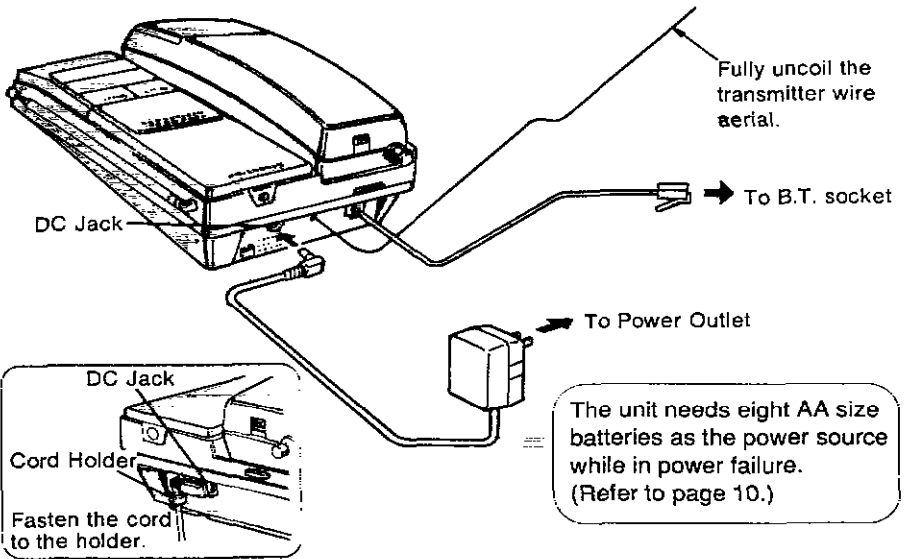

- 2 Charge the battery about 10 hours by placing the portable unit on the cradle. See page 8.

- 3 Extend the Telescopic Antenna fully and vertically.

- 4 Set to "ERE" or "TBR".

(depending on PBX type)

ERE...for PBX earth recall facility

TBR...for PBX timed break register recall facility

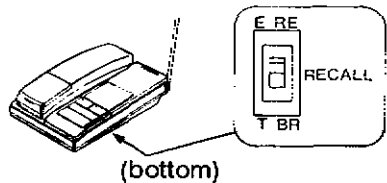

- 5 Set to "STANDBY".

- When you do not want the telephone to ring, set to "OFF".

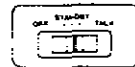

- 6 Set to "TONE".

If dialing cannot be done, set to "PULSE".



Location of Controls

PORTABLE UNIT

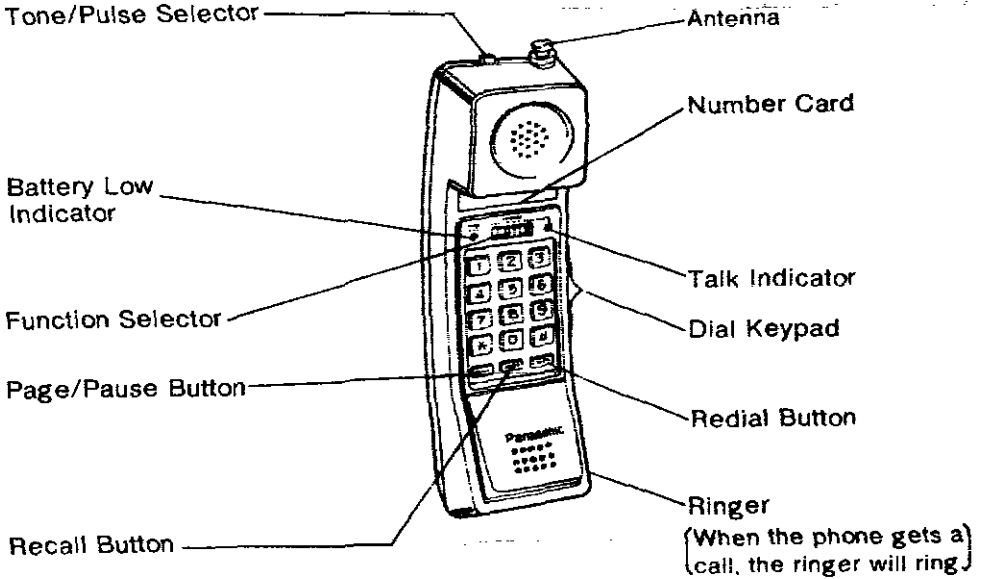

BASE UNIT

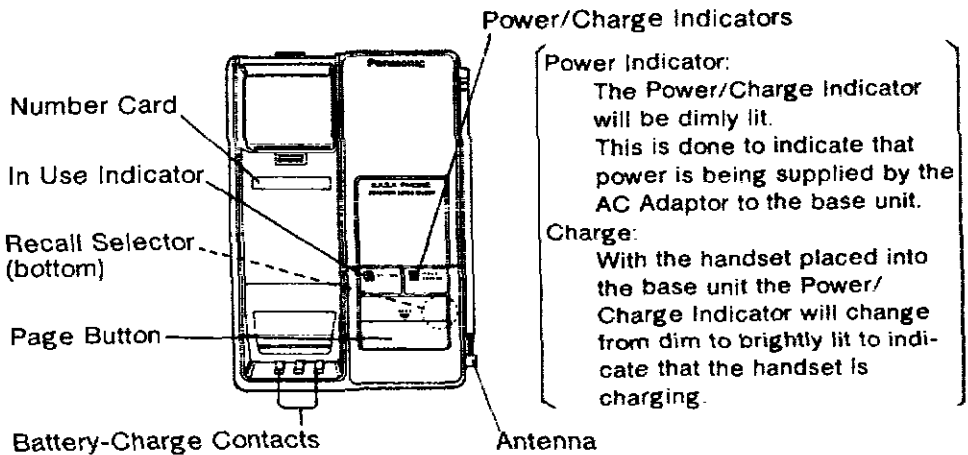

Dialing and Receiving

Receiving

- Be sure the selector is set to "STANDBY".
- 1 When the phone rings, set to "TALK".

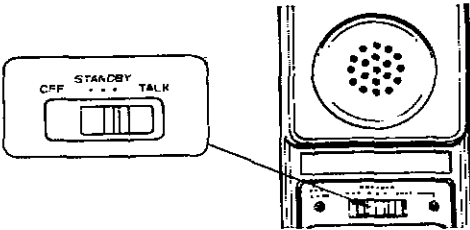

- 2 When you finish, set to "STANDBY".
 - When set to "OFF", the phone will not ring.

Dialing

- 1 Set to "TALK".
 - The Talk and in Use Indicators will light.
 - Identify dialing Tone.

■ Home Use



■ Office Use (PBX)

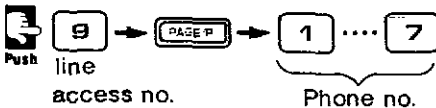

Do not push the PAUSE button more than twice following the initial access digit (or digits). Failure to comply with this requirements may result in unsatisfactory operation.

- 3 When you finish, set to "STANDBY".

Redialing

If the line is busy,



To redial the last dialed number, do not set to "OFF".

Pause usage

The Pause button function is needed for an outside line access number or a computer accessed line.

- Especially in manual dialing, a pause is required for the redialing.

To wait for a dial tone (PBX)

9-PAUSE-123...7

One pause is required.

To wait for a computer tone

765...1-PAUSE-PAUSE-012...6

Two pauses are required.

Recall Button

To access an outside line using the PBX recall facility, press the Recall Button.

Depending on type of switching equipment to which Easa-Phone is connected, various functions, such as transfer, recall and hold can be initiated.

■ Dialing

Pulse mode: Up to 30 digits
Tone mode: Unlimited
Redialing: Up to 30 digits

- Changing the Tone/Pulse Selector or Pushing Pause Button } Counts as 1 digit.

Transferring an Incoming Call

- The base unit user will be able to receive a call and transfer it to the portable unit. This is done by connecting another telephone to the base unit and doing as follows.

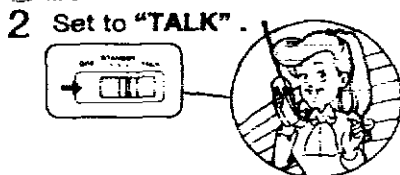
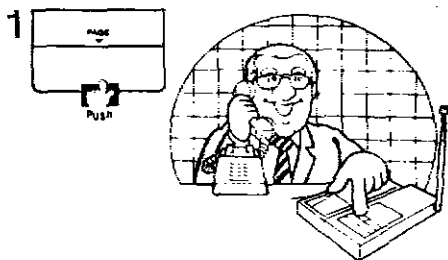
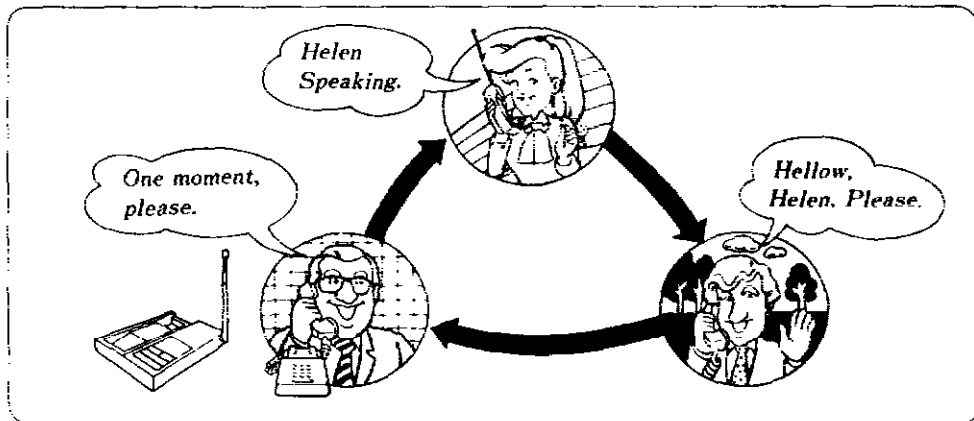

2-Way Paging

- 3 Hang up.
- Keep the handset off-hook for a three way conversation.



To terminate the call, set to "STANDBY".

You can page between base and portable unit.

- To call Portable Unit from Base Unit

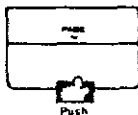

- To call Base Unit from Portable Unit

- Be sure the selector is set to "STANDBY" on Portable Unit.



Charging the Portable Unit

Charge the battery for about 10 hours by setting the Function Selector to the "OFF" position before initial use or if the Battery Low Indicator lights.

How to charge

Place the handset on the cradle.

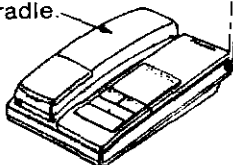

The portable unit is always being charged while on the cradle.

- Keep the battery Charge Contacts clean.

NOTES:

- Even when the Battery Low Indicator lights, the portable unit will still function for a short period of time. However, charge the battery in a short time.
- While charging in the "OFF" position, the telephone will not ring. Other phones connected on the same line will work.
- If you want the telephone to ring while charging, set the Portable Unit to the "STANDBY" position. The charging time required in the "STANDBY" position is more than that in the "OFF" position.

We recommend that you charge the battery with the Function Selector set to the "OFF" position. This is done as to fully charge the battery in the least amount of time.

Battery Replacement

Replace the battery only for the following condition:

The battery has been charged for 10 hours, but the Battery Low Indicator lights after a few telephone calls.

How to remove the battery

- Unplug the connection to the BT network before opening the cover.

- 1 Remove the battery compartment cover.

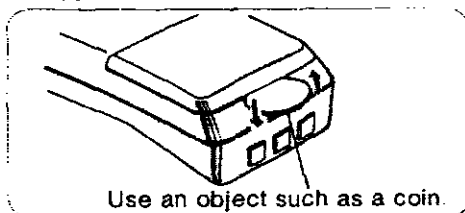

- 2 Disconnect the battery.

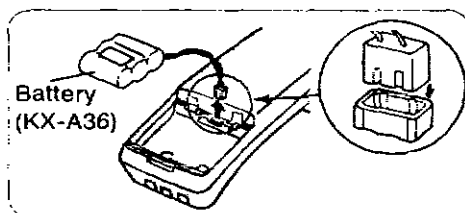

How to install the battery

Follow the opposite procedure of above.

Please use only Panasonic Battery KX-A36.

Battery Installation

Eight AA size batteries serve as the power source to use the unit while in power failure.

To Install the Back-up Batteries

● **Unplug the connection to the BT network before opening the cover.**

- 1 Open the battery compartment cover as shown.
- 2 Insert the eight AA size batteries in the proper order as indicated observing the correct polarity.
- 3 Close the battery compartment cover.

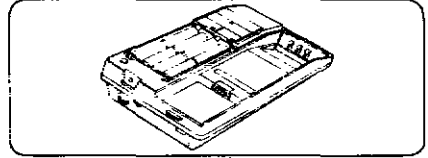
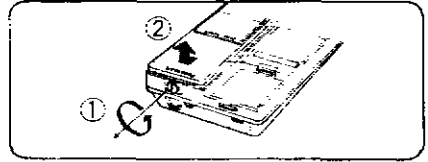

Troubleshooting Guide

Problem	Cause & Remedy
The unit dose not work.	<ul style="list-style-type: none">● The battery is in need of charging.● The AC Adaptor is not plugged into an outlet.● No telephone line connection is made.● The telephone line connection is made improperly.● The telescopic antennas are not fully extended.
Dial Tone is not heard.	<ul style="list-style-type: none">● See the above-mentioned possible causes.● You are too far from the Base Unit. Move closer to Base Unit.● Set the Function Selector to "STANDBY" then set it to "TALK".
The portable unit dose not ring.	<ul style="list-style-type: none">● Make sure the Function Selector is set to "STANDBY".
Sound flutters or fades.	<ul style="list-style-type: none">● You are too far from the Base Unit. Move closer to Base Unit.
I charged the battery for 10 hours, but the Battery Low Indicator lights after a few telephone calls.	<ul style="list-style-type: none">● It is high time to change the battery. Please replace.

Others

- If there is any trouble, disconnect the unit from the telephone line and connect a known working phone. If the known working phone operates properly, have it repaired by one of the specified Service Centers. If the known working telephone does not operate properly, consult with a telephone company.

- Locate the Base Unit in the highest area of the house to obtain the maximum range.

- The Channel No. indicates the frequency at which the unit operates.

- Do not cover the vents on the bottom of the cabinet.

- Never attempt to insert wires, pins, etc. into the vents or other holes in this unit.

- Keep the unit away from heating appliances and electrical noise generating devices such as fluorescent lamps and motors.



- The unit should be kept free of dust, moisture and vibration, and should not be exposed to direct sunlight.



- Do not use benzine, thinner, or the like, or any abrasive powder to clean the cabinet. Wipe it with a soft cloth.



WARNING

TO PREVENT FIRE OR SHOCK HAZARD, DO NOT EXPOSE THIS PRODUCT TO RAIN OR ANY TYPE OF MOISTURE.

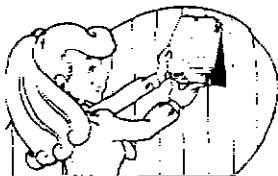

Wall Mounting

This unit can be mounted on the wall utilizing the template and screws provided.

Preparation

- 1 Turn over the handset guide.

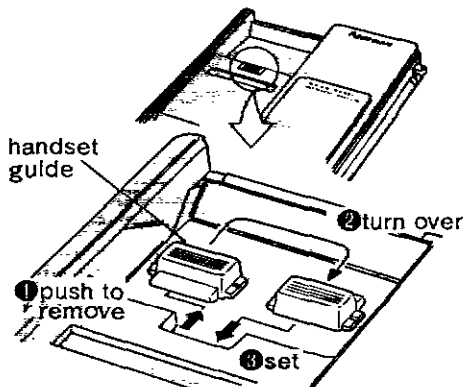

- 2 Attach the included Wall-mounting adaptor to the unit by pushing it in the direction of arrow A and then B.

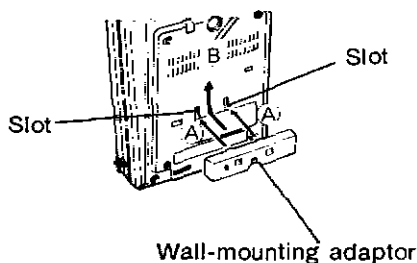

- 3 Place the template on the wall.

- 4 Using the washers fix the screws to the wall in the positions indicated.

- 5 Mount the unit on the wall so that the screw heads insert into the slots on the bottom, and then slide the unit down to hook it securely, as shown.

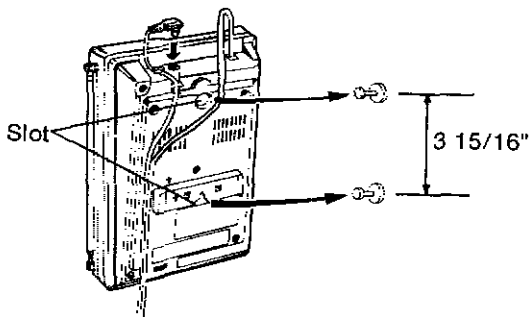

- To temporarily place the handset down during a conversation, hook as shown.

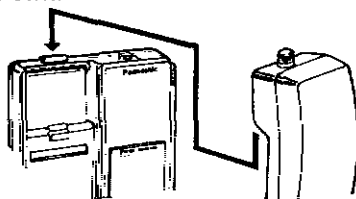

Wall Template

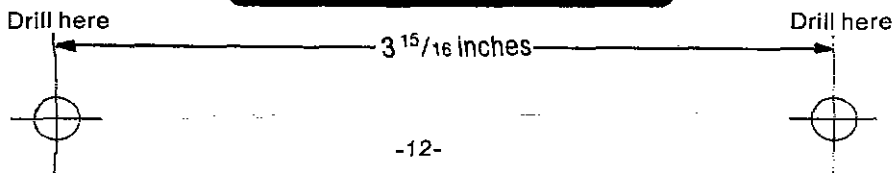

GUARANTEE CONDITIONS OF GUARANTEE

This guarantee is in addition to and does not in any way affect any statutory or other rights of consumer purchasers.

If within the applicable guarantee period, the appliance proves to be defective by reason of faulty design, workmanship or materials, we undertake subject to the following conditions to have the defective appliance (or any part or parts thereof) repaired or replaced free of charge.

1. The appliance shall have been purchased and used solely within the UK and in accordance with standard operating instructions and the technical and/or Safety Standards required in the UK.
2. The purchaser will within 7 days of purchase complete the included card and send it to us for registration. Failure to return such card could result in delay in providing the guarantee service.
3. *The appliance should be returned together with this guarantee and proof of date of purchase promptly on being found defective at the purchaser's risk and expense to the authorized dealer from whom the appliance was purchased or to the nearest authorized dealer. All enquiries must be through such dealers.*
4. This guarantee shall not apply to damage caused through fire, accident, lightning, misuse, wear and tear, neglect, incorrect adjustment or repair, to damage caused through installation, adaption, modification or use in an improper manner or inconsistent with the technical and/or safety standards required in the country where this appliance is used, or to damage occurred during transit to or from the purchaser.
5. If at any time during the guarantee period any part or parts of the appliance are replaced with a part or parts not supplied or approved by us or of an objective quality safe and suitable for the appliance, or the appliance has been dismantled or repaired by any person not authorized by us, we shall have the right to terminate this guarantee in whole or in part immediately without further notice.
6. *The purchaser's sole and exclusive remedy under this guarantee against us is for the repair or replacement of the appliance or any defective part or parts and no other remedy, including, but not limited to, incidental or consequential damage or loss of whatsoever nature shall be available to the purchaser.*
7. This guarantee shall not apply to cassette tapes, batteries and any other items of limited natural life.
8. Our decision on all matters relating to complaints shall be final. Any appliance or defective part which has been replaced shall become our property.
9. The guarantee period applicable to this product shall be 12 months.

Please keep this Operating Instructions with your receipt.

Panasonic Business Systems U.K.

RECEIPT No.	DATE OF PURCHASE
MODEL No. KX-T3816BE	SERIAL No.